



Mekong River Commission

# Guidance for Efficient Irrigation Water Use in the Lower Mekong River Basin

Consultant's Report

February 2010



Meeting the Needs, Keeping the Balance





Mekong River Commission

# Guidance for Efficient Irrigation Water Use in the Lower Mekong River Basin

Consultant's report

February 2010

Published in Vientiane, Lao PDR in February 2010 by the Mekong River Commission

Cite this document as:

MRC (2010) Guidance for Efficient Irrigation Water Use in the Lower Mekong River Basin, Consultant's report, Mekong River Commission, Vientiane. 102 pp.

The opinions and interpretation expressed within are those of the authors and do not necessarily reflect the views of the Mekong River Commission.

Authors: N. Horikawa, T. Masumoto

Editor: J. Simery

Graphic design: J. Simery

© Mekong River Commission

184 Fa Ngoum Road, Unit 18, Ban Sithane Neua, Sikhottabong District,  
Vientiane 01000, Lao PDR

Telephone: (856–21) 263 263 Facsimile: (856–21) 263 264

E-mail: [mrcs@mrcmekong.org](mailto:mrcs@mrcmekong.org)

Website: [www.mrcmekong.org](http://www.mrcmekong.org)

# Table of contents

Aknowledgements.....	ix
Abbreviations and acronyms.....	xi
1. Introduction.....	1
1.1 Scope of this guidance .....	1
1.2 Limitations of this guidance .....	2
1.3 Water loss in an irrigation system: origins and countermeasures .....	3
1.4 Classification of irrigation in the LMB.....	4
2. Seasonal irrigation planning .....	7
2.1 Outline of seasonal irrigation plan.....	7
2.2 Key issues for improving a seasonal irrigation plan.....	9
3. Irrigation scheduling and facility operations .....	25
3.1 Outline of irrigation scheduling .....	25
3.2 Key issues to improve irrigation scheduling.....	28
3.3 Reservoir operations .....	37
3.4 Canal operations .....	38
4. Water management of tertiary canals.....	51
4.1 Establishment of WUAs .....	53
4.2 Prohibition of turnout operation by water users .....	54
4.3 Intermittent water delivery to tertiary canals.....	55
4.4 Enhancement of plot-to-plot irrigation practices .....	56
5. Improvement of physical structures.....	61
5.1 Installation of regulating reservoirs .....	61
5.2 Installation of cross-regulators.....	61
5.3 Improvement of canal systems .....	62
5.4 Construction of tertiary canals.....	64
5.5 Installation of remote monitoring and control systems .....	66
5.6 Installation of automatic gates .....	67
5.7 Facilities for reuse of irrigation water.....	69
5.8 Construction of regulators and canal improvement in low-lying systems.....	70
6. Managerial and technical aspects.....	73
6.1 Monitoring .....	73
6.2 Water requirement.....	74
6.3 Organisation.....	77

6.4 Role of maintenance .....	78
6.5 Institutional system design .....	79
References.....	83
Appendix: Case study .....	85

## Table of figures

Figure 1.1	Scope of the guidance for Efficient Irrigation Water Use in the Lower Mekong Basin .....	1
Figure 1.2	Water loss in an irrigation system: origins and countermeasures .....	3
Figure 1.3	Classification of irrigated lands in irrigation facilities in the LMB (0.1° mesh)(Shimizu <i>et al.</i> ,2006).....	5
Figure 2.1	Procedure used for seasonal irrigation planning .....	9
Figure 2.2	Water losses occurring along the boundaries of irrigated areas and canals ..	13
Figure 2.3	Schematic diagrams of scattered and converged irrigation areas.....	14
Figure 2.4	Rotation of irrigated area.....	15
Figure 2.5	Rice growing periods and monthly precipitation in Muda, Malaysia (Yamaoka <i>et al.</i> 2004) .....	16
Figure 2.6	Extension of the irrigation period induced by delayed crop establishments.	17
Figure 2.7	Effect of a distributed irrigation period on the peak demand of water at the start of the irrigation period .....	18
Figure 2.8	Example of a distributed irrigation period (Nanbu, 2002) .....	18
Figure 2.9	Control of water level in low-lying areas.....	21
Figure 2.10	Shifts in water level in a tidal irrigation system.....	21
Figure 2.11	Water balance analysis (Kaneko, 1973) .....	22
Figure 2.12	Change of controlled water level in a flood-prone irrigation system.....	23
Figure 2.13	Estimation of water intrusion in an inundated irrigation area .....	24
Figure 3.1	Comparison between seasonal irrigation planning and irrigation scheduling.....	25
Figure 3.2	Water supply determined by irrigation scheduling.....	26

Figure 3.3	Bulletin board informing water users in each sub-irrigation system of the water delivery rotation at irrigation turnouts .....	27
Figure 3.4	Comparison of flow in continuous and intermittent water supply methods..	29
Figure 3.5	Variation of the irrigation efficiency depending on the amount of water supplied .....	29
Figure 3.6	Estimations of flow rates in continuous and intermittent supply methods....	31
Figure 3.7	Example of factors that can be examined in field surveys .....	33
Figure 3.8	Overflow from a tertiary canal .....	34
Figure 3.9	Flow chart of water delivery under the ordering system.....	36
Figure 3.10	Constraint curves for reservoir operations .....	38
Figure 3.11	Changes in flow rates of diverted water with fluctuations in water level .....	40
Figure 3.12	Causes of water level fluctuations and countermeasures .....	41
Figure 3.13	Operation from upstream to downstream in sequence .....	42
Figure 3.14	Frequent gate operation .....	43
Figure 3.15	Differences between flow rate and water level measurements.....	44
Figure 3.16	Estimation of travel time .....	46
Figure 3.17	Features of upstream and downstream controls by cross-regulators.....	47
Figure 3.18	Use of a cross-regulator as a regulating reservoir .....	48
Figure 3.19	Communication between operators in order to save water .....	49
Figure 3.20	Communication between operators at different levels .....	50
Figure 4.1	Water distribution and water loss in a tertiary canal .....	52
Figure 4.2	Excessive water in a farm plot as a result of excessive water supply .....	53
Figure 4.3	Impact of prohibiting individual turnout operation on water supply (Ren <i>et al.</i> 2005).....	54



Figure 4.4	Illustration of a step-by-step water delivery system along a tertiary canal ...	55
Figure 4.5	Schematic explanation of, and issues related to, plot-to-plot irrigation.....	57
Figure 4.6	Implementation of water-use mapping (Tomosho <i>et al.</i> 2006, 2007) .....	59
Figure 5.1	Use of a cross-regulator to improve smooth diversion of water .....	62
Figure 5.2	Control of natural flows.....	63
Figure 5.3	Elimination of direct turnouts through the use of tertiary canals.....	64
Figure 5.4	An example of tertiary canal expansion to reduce delivery time.....	65
Figure 5.5	Increase in the number of spill points through tertiary canal expansion.....	66
Figure 5.6	A centre for remote monitoring and control.....	67
Figure 5.7	Automatic gate (control of water level upstream) accompanied by a manual gate .....	68
Figure 5.8	Water reuse from adjacent drainage canals .....	69
Figure 5.9	Drainage and irrigation canals and pump station for water reuse .....	70
Figure 5.10	Construction of regulators for expansion of a gravity-irrigated area .....	71
Figure 5.11	Target basin, schematic diagram, and results of inundation analysis.....	72
Figure 6.1	Density of rainfall stations and accuracy of estimated rainfall .....	74
Figure 6.2	Design and actual effective rainfall.....	75
Figure 6.3	Components of water balance in a farm plot.....	76
Figure 6.4	Irrigation facility changes as a result of IMT .....	78
Figure 6.5	Water and material cycles in low-lying areas.....	80

## List of tables

Table 1.1	Features of irrigation systems in the Lower Mekong Basin.....	2
Table 2.1	Major elements of the seasonal irrigation plan .....	7
Table 2.2	Estimation of water resources .....	11
Table 3.1	Comparison of continuous and intermittent supply methods.....	31
Table 3.2	Type and features of different ways to estimate water demand .....	32
Table 3.3	Types of turnout operations.....	45

# Aknowledgements

The Mekong River Commission (MRC) is implementing Improvement of Irrigation Efficiency on Paddy Fields in the Lower Mekong Basin project (IIEPF) in order to improve irrigation efficiency at basin-wide scale. The project is funded by the Ministry of Agriculture, Forestry and Fisheries, Japan (MAFF) under the framework of the ‘Programme to Analyse and Evaluate Water and Ecosystems in Asian Paddy Fields’. The project is implemented in close cooperation with the National Mekong Committees (NMCs) and their relevant line agencies (LAs).

To contribute to the overall objective of the project, IIEPF conducted field observation at four selected pilot sites in the Member Countries. These field observations revealed the current situation of irrigation water management by observing the irrigation efficiency and other performance indicators and documented rules, regulations and other procedures practically applied on the sites.

Based on collected information, IIEPF planned to propose a guidance for efficient irrigation water use covering institutional, managerial and technical aspects of irrigation facility operations to achieve the project overall objective. In addition to promoting efficient water use, the proposed guidance is expected to enhance multi-functionality of paddy agriculture and paddy field irrigation.

In this regard, the National Institute for Rural Engineering (NIRE) was familiar with both practical irrigation facility operation and multiple functions of paddy agriculture as well as paddy field irrigation and was contracted as a consultant to propose the guidance.

This document presents the results of the guidance for efficient irrigation water use, which includes a case study on four pilot project sites and the outputs/findings produced under the IIEPF with the Member Countries (including field activities).

We would like to express our appreciation to the officers of the Agriculture, Irrigation and Forestry Programme (AIFP). Useful comments on this or earlier materials were given by them. We would also like to express our appreciation to the National Mekong Committees, line agencies and working teams of the pilot projects who were always active.

We hope this guidance will be used by irrigation project staff, ministry officials and persons who are engaged in operation and maintenance and will be useful in promoting efficient irrigation use in related countries.

Naoki HORIKAWA  
Takao MASUMOTO,  
National Institute for Rural Engineering, NARO



## Abbreviations and acronyms

AEWEPF	Programme to analyse and evaluate water and ecosystem in Asian paddy fields
AIFP	Agriculture, Irrigation and Forestry Programme
CHO	Constant Head Orifice
DP	Dynamic Programming
DDDP	Discrete Differential Dynamic Programming
E	Evaporation
ET	Evapotranspiration
FWUC	Farmer water users community
IIEPF	Improvement of Irrigation Efficiency on Paddy Fields in the Lower Mekong Basin project
IMC	Irrigation Management Company
IMT	Irrigation Management Transfer
IWUG	Integrated Water Users' Group
JMC	Joint management committee
LA(s)	Line Agency(ies)
LMB	Lower Mekong Basin
LWL	Lower Water Level
MAFF	Ministry of Agriculture, Forestry and Fisheries, Japan
MCM	Million Cubic Meters
MRC	Mekong River Commission
MWL	Maximum Water Level
NIRE	National Institute for Rural Engineering, Japan
NMC(s)	National Mekong Committee(s)
O&M	Operation and management
PIM	Participatory Irrigation Management
PDWRAM	Provincial Department of Water Resources and Meteorology, Cambodia
RID	Royal Irrigation Department, Thailand
TWL	Target Water Level
UWL	Upper Water Level
WUA(s)	Water Users' Association(s)
WUC(s)	Water Users' Council(s)
WUG(s)	Water Users' Group(s)
WUO(s)	Water Users' Organisation(s)



# 1. Introduction

## 1.1 Scope of this guidance

The purpose of this guidance is to show options for efficient irrigation water use which covers institutional, managerial and technical aspects of irrigation facility operations in order to improve irrigation efficiency on a basin-wide scale by reducing the amount of water losses.

In general, there are three stages in the implementation of an irrigation project (Figure 1.1): planning, design (construction), and operation and maintenance (O&M). This guidance deals mainly with O&M for efficient irrigation water use in the irrigation systems of the Lower Mekong Basin (LMB). Although O&M includes operation, maintenance and management, the main focus of this guidance is on operation, that is, irrigation planning (water allocation) and irrigation scheduling (daily water distribution). Related issues in the planning stage, and maintenance and institutional management in the O&M stage, are also touched upon where they contribute to the improvement of irrigation efficiency.

The main users of this guidance are staff who are engaging in the daily operations of irrigation schemes. However, part of the guidance may be referred to officials who belong to planning and design sections of national and/or local governments. It is not expected that farmers will use this guidance as information related to on-farm water management is not provided herein.

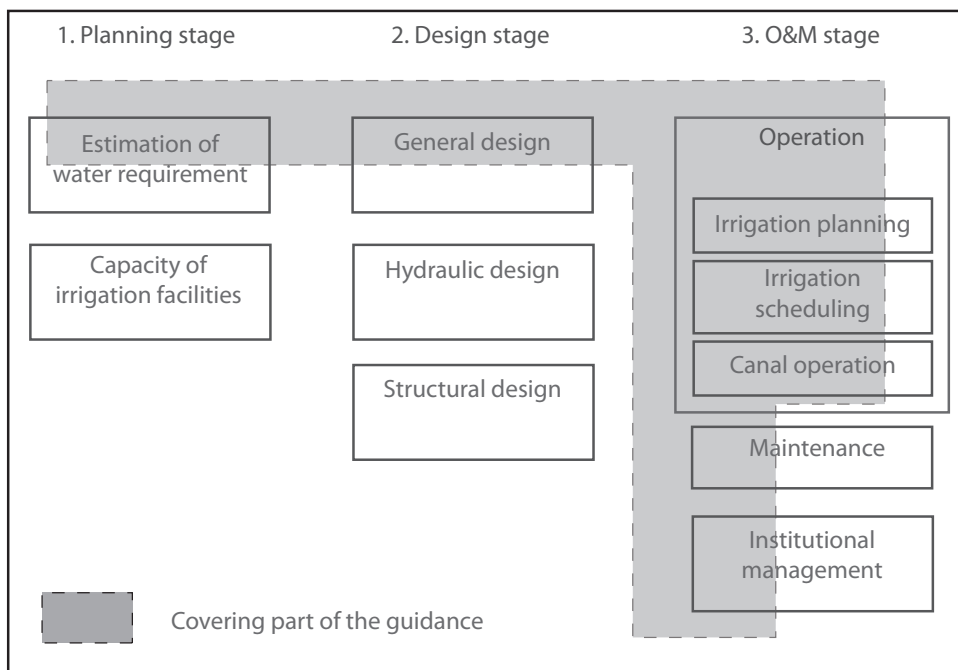

Figure 1.1 Scope of the guidance for Efficient Irrigation Water Use in the Lower Mekong Basin

The features of the irrigation systems in the LMB are shown in Table 1.1.

Table 1.1 *Features of irrigation systems in the Lower Mekong Basin*

	Possible variations	Features in the LMB
Canal system	Pipeline, Open channel, Mixed system	Open channel
Farm size	Estates, Large farms, Small farms	Small farms
Main crop	Rice, Maize, Wheat, Barley and others	Rice
Irrigation system	Demand oriented, Supply oriented	Supply oriented
Climate	Polar, Temperate, Arid, Tropical, Mediterranean	Tropical monsoon

The method of water distribution and canal operation depends on the type of canal system. In the LMB, open-channel irrigation systems prevail and few irrigation systems employ pipelines; this guidance therefore covers only open channel systems out of three kinds of irrigation canal systems (for example, open channel, closed pipeline, and mixed).

The average farm held by farming households in the region is small (from 1 to 4 ha, cf. 17 ha in Europe, 180 ha in the United States, and 3400 ha in Australia). This means that large numbers of farmers (water users) are stakeholders in system operations, hence the difficulty for irrigation systems to cope with the requests of so many different water users.

The main crop in the LMB region is rice, particularly in irrigated areas, so the primary target of this guidance is irrigation systems in which paddy fields are dominant. However, this guidance can also be adapted for use in upland crop areas in this region.

## 1.2 Limitations of this guidance

The planning of an irrigation project, the design and construction of irrigation facilities, and the O&M of completed irrigation systems should be conducted under the same framework. However, each country has its own priorities in terms of guidelines and standards. When the guidance contradicts any country guidelines or standards, the guidance can be adapted or relevant points chosen from it; this guidance is thus not always the absolute standard.

In addition, irrigation management depends on the social and environmental circumstances in which the irrigation system is located; these factors should be taken into consideration to avoid conflict between the guidance and the reality of its practical application.

Furthermore, improvement of irrigation management moves forward incrementally, in that measures that are easier to apply are implemented at an earlier stage and the more difficult ones at a later stage. In this respect, the guidance also follows the same order for ease of application, from Chapter 2 (seasonal irrigation plan: water allocation), to Chapter 3 (irrigation scheduling: water distribution), Chapter 4 (canal operations), and finally Chapter 5 (water management



in tertiary canals). In some cases, several alternatives are presented in each chapter to suit the features of different irrigation systems.

### 1.3 Water loss in an irrigation system: origins and countermeasures

Water losses in an irrigation system occur from: (a) seepage and leakage from canals; (b) evaporation (E) or evapotranspiration (ET) from canals and riparian land; (c) spillage from canal systems; (d) drainage from farm plots (Figure 1.2).

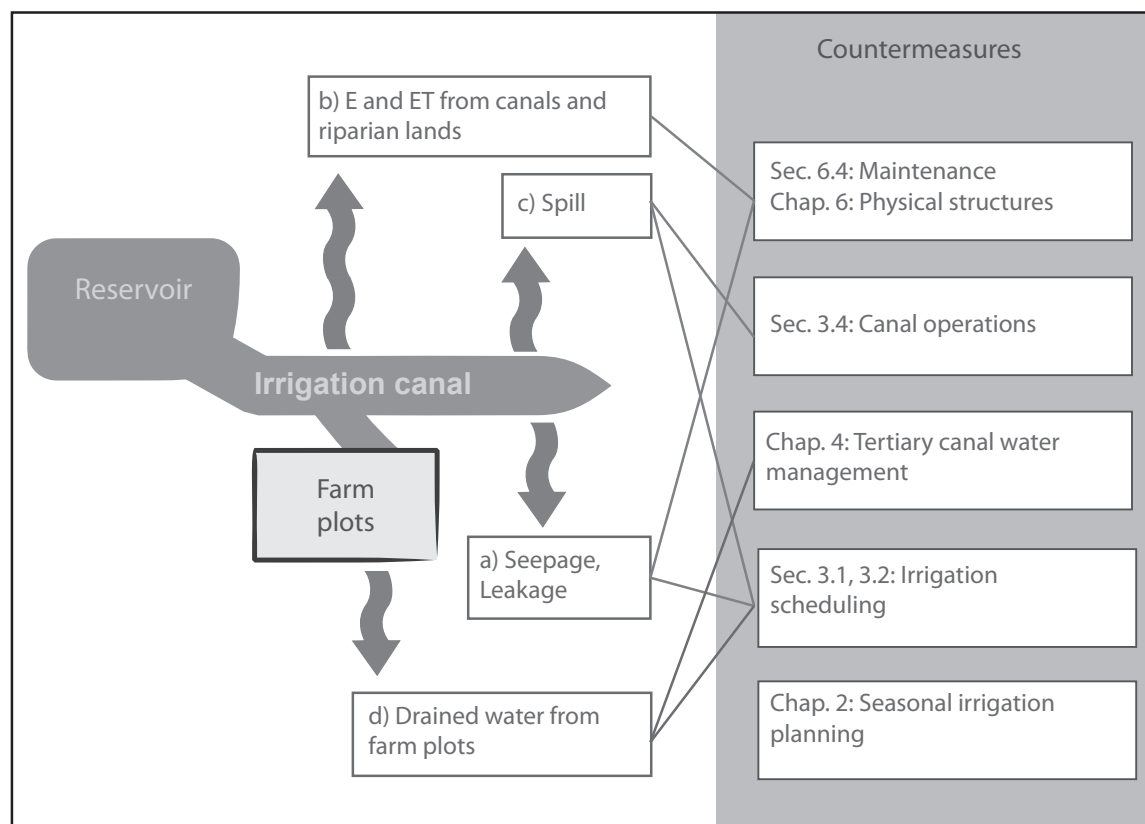

Figure 1.2 Water loss in an irrigation system: origins and countermeasures

These losses should be reduced to improve irrigation efficiency. The loss of water can be countered by applying several measures. Seepage and leakage from canals (a) and evaporation or evapotranspiration from canals and riparian lands (b) can be reduced by suitable maintenance (see section 6.4) and the improvement of physical structures (see Chap. 5). Spillage of water from a canal system (c) can be directly prevented by the application of appropriate canal operations (see section 3.4). Drainage of water from farm plots (d) may be decreased by direct management of water in tertiary canals (see Chap. 4). In addition, spillage of water from a canal system (c) and drainage of water from farm plots (d) can also be decreased by appropriate water distribution (see sections 3.1, 3.2). Shortening the irrigation period is another way to reduce

all water losses. Water allocation (see Chap. 2) plays an important role in setting an irrigation period.

Those measures are supported by monitoring of the system (see section 6.1), estimation of water requirements (see section 6.2), organisation of water management (see section 6.3), and institutional system design (see section 6.5).

## 1.4 Classification of irrigation in the LMB

There are six main classifications of irrigation in the LMB depending on the type of facilities: 1) reservoir, 2) weir, 3) pump irrigation, 4) colmatage system, 5) sluice, and 6) groundwater use (Shimizu *et al.* 2006). Agricultural land in the LMB was mapped on a 0.1° grid (10 km mesh) on the basis of these categories (Figure 1.3). The figure shows the predominant type of irrigation facilities used in each grid. Groundwater use is not shown in this figure due to the lack of information.

General features of the irrigation systems used in irrigated fields in the LMB are as follows:

1. Reservoir: This irrigation system can be seen mainly in the Northeast of Thailand. The storage capacities of the reservoirs vary from less than 100,000 m<sup>3</sup> to about 500 million m<sup>3</sup>, and the beneficiary areas vary also widely, from several hectares to 32,000 ha. There are about 8000 reservoirs identified in the database created by MRC. Areas categorised as using irrigation of this type are located in the Northeast of Thailand, the central highlands of Viet Nam, and around the Great Lake of Cambodia.
2. Weir and canal: Gravity irrigation is seen in all riparian countries of the LMB.
3. Pump: Pump irrigation is used mainly in the Lao PDR and the Northeast of Thailand. Large and medium-sized pumps are used along the Mekong River and its tributaries. Small mobile pumps, which are usually used to deliver water from tertiary canals, and/or local natural land depressions to paddy fields, are not included in the map in Figure 1.3.
4. Colmatage: Colmatage is an irrigation system unique to Cambodia. The system employs a canal directly connected to a river to divert and store floodwater with fertile suspended sediments during wet seasons. Upland crops are grown upstream along the canal and paddy rice is grown downstream. There are about 400 colmatage canals identified along the Mekong and Bassac rivers and some tributaries of the Great Lake.
- 5) Sluice: Sluices and/or gates in the coastal areas of the Mekong Delta in Viet Nam protect against tidal saline water intrusion. These facilities are closely related to tidal irrigation.

6) Groundwater use: The use of groundwater from tube wells has been rapidly expanding in the southern part of Cambodia, especially in the Takeo, Kandal, and Kampong Cham provinces.

Submerged irrigation, tidal irrigation in the Mekong Delta and colmatage systems have common water allocation and water distribution features. In this guidance, these areas are collectively called low-lying irrigation systems.

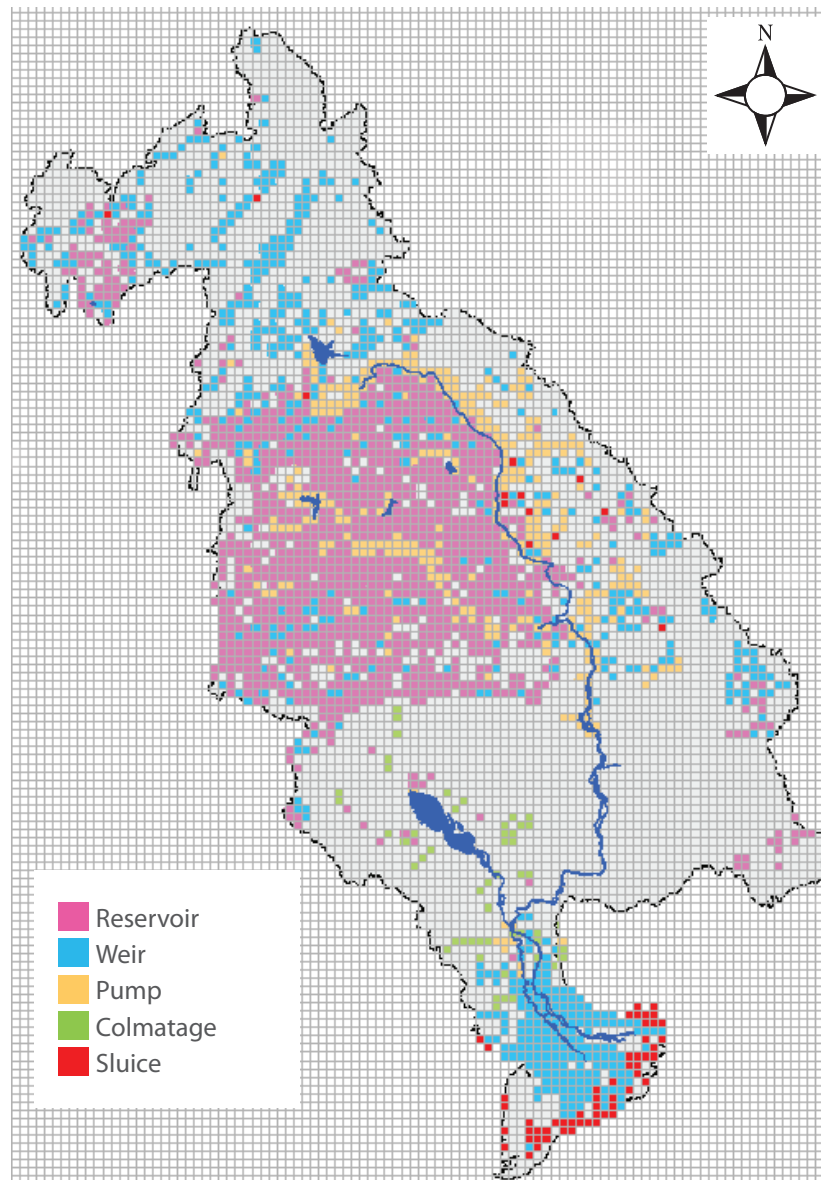

Figure 1.3 Classification of irrigated lands in irrigation facilities in the LMB (0.1° mesh)(Shimizu *et al.*, 2006)



## 2. Seasonal irrigation planning

### 2.1 Outline of seasonal irrigation plan

*The seasonal irrigation plan determines the area irrigated, crop cultivated, irrigation period, and available irrigation water volume for a coming irrigation season to ensure a reliable water supply. It is based on careful studies of available water, water requirements, and other related factors. Present and future amounts of available water are allocated to irrigation and other uses in the plan.*

#### **Elements of a seasonal irrigation plan**

For efficient water use, irrigation plans should be determined and water users informed of them. In this guidance, an irrigation plan determined once before the irrigation season is referred to as ‘seasonal irrigation plan’ and irrigation plans determined many times in the irrigation season are referred to as ‘irrigation schedule’.

In seasonal irrigation planning, available water in a coming irrigation season is allocated appropriately to meet each water demand. The plan should describe the area to be irrigated, the crops cultivated, the irrigation period, and the volume of water available for irrigation (Table 2.1). Water delivery methods, such as the way in which water will be supplied at each turnout and for multiple uses, may also be determined. The available water (water supply) and water requirements (water demand) in the coming irrigation season must first be estimated and compared. If the amount of water is insufficient to meet water demand, then full irrigation will need to be reduced in the area irrigated and so on (see page 11).

Table 2.1 *Major elements of the seasonal irrigation plan*

Area irrigated	The area to be irrigated is determined by comparing water supply and water demand for the whole irrigation system. Once this potential area has been determined, it is divided into areas to be irrigated by sub-systems of the whole irrigation system. In each sub-system, organisations of water management such as WUAs <sup>i</sup> allocate water to irrigable farm plots or water users.
Crop cultivated	The crop to be cultivated and its area are determined.
Irrigation period	Starting and ending dates of irrigation are determined for the whole irrigation system and for all sub-systems (see page 15 and 16).
Water volume	Available water volume is allocated to water user sectors for an upcoming season. Allocations are preferably made over monthly or weekly time spans.

<sup>i</sup> WUA (*Water Users’ Association*): *WUA is a group of water users managing an irrigation system. There are many terms referring to this kind of groups such as WUA, WUG( Water Users’ Group), IWUG(Integrated Water Users’ Group), WUO(Water Users’ Organisation), WUC*

*(Water Users' Council) according to their roles in each country. In this guidance, all groups of water users are called WUA, including a village if it operates a water management body.*

## **Importance of seasonal irrigation planning and reliability of water allocation**

Reliability is an important factor in irrigation management. Reliability of water management is achieved by supplying irrigation water as planned. If the irrigation plan is not implemented correctly, water users will lose faith in the water management system and water management will malfunction. Therefore, the seasonal irrigation plan has to be feasible in order not to fail. Reliability of water management depends strongly on a careful preparation of the seasonal irrigation plan. Plans that are difficult to implement should not be selected even if they look effective in terms of efficient water use.

## **Planning procedure**

A seasonal irrigation plan should be set up in time for the start of the irrigation season. The procedure for establishing a seasonal irrigation plan is outlined in Figure 2.1.

### **1. Investigating water requirements and water resources**

Information on water requirements and water resources is collected to examine seasonal irrigation plans. Water users are interviewed about what kind of crops will be grown, how much area is required for planting and when the crops are to be planted (see page 9). Past records of water requirements and crop information such as cultivated area are collected, so that future water requirements can be estimated. Information on water resources such as the present storage volumes of reservoirs and past meteorological data is also collected.

### **2. Drafting a seasonal irrigation plan**

A seasonal irrigation plan is drafted on the basis of available water resources and previously collected water requirements. In this plan, available water is estimated from the present water conditions and the expected water resources of the coming irrigation season. Meanwhile, water requirements for irrigation are estimated by using crop water requirements, effective rainfall, crop information and irrigation efficiency (see page 10).

### **3. Approving the seasonal irrigation plan**

After the plan is drafted, meetings are called to discuss it (see page 9). The plan is presented to stakeholders, who will examine, revise (if necessary), and finally approve it.

4. Detailing the seasonal irrigation plan

Once the seasonal irrigation plan is approved for the whole irrigation system, the plan needs to be scrutinised in terms of practical application. Irrigation areas and periods of sub-irrigation from secondary and/or tertiary canals are decided in accordance with the plan for the whole system.

5. Announcing the plan

Water users are informed of the seasonal irrigation plan through organisations or the mass media so as to get ready for the coming irrigation season.

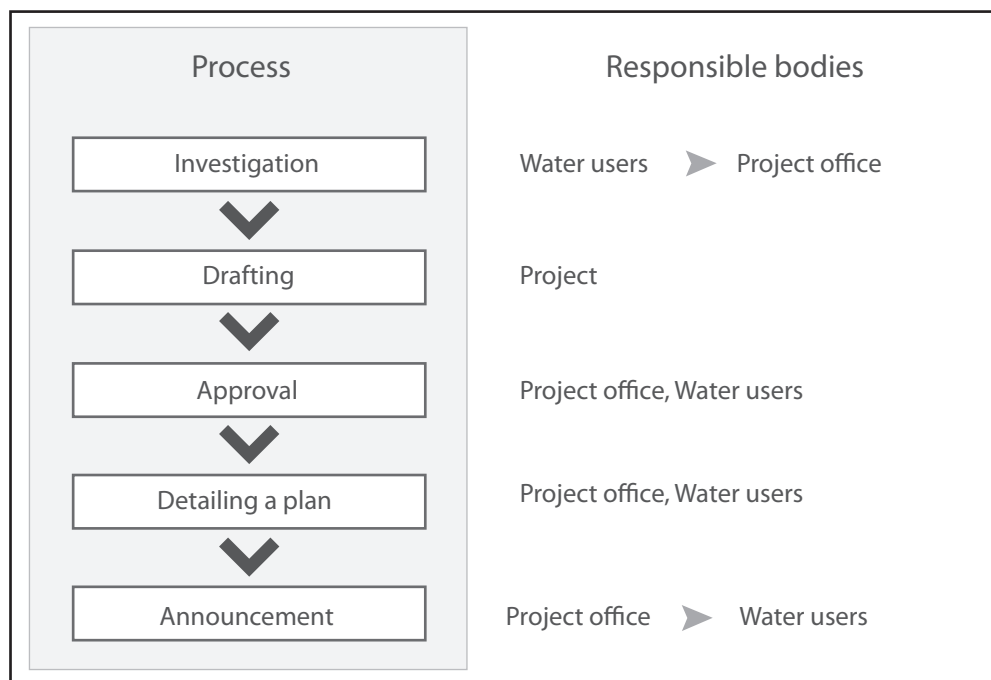

Figure 2.1 Procedure used for seasonal irrigation planning

## 2.2 Key issues for improving a seasonal irrigation plan

### Involvement of water users in the decision making process

*Water users such as farmers are involved in the process of decision making for the seasonal irrigation plan. Before the plan is drafted, water users' requests for the coming irrigation season should be surveyed. Once the plan is drafted, it needs to be agreed on by water users before implementation. Modifications to the drafted plan and its finalisation, should be announced to all water users.*

All water users should follow the seasonal irrigation plan in principle. In many cases where the plan has failed, a lack of full involvement of water users in the planning process has been found to be a major reason. If the plan does not have the input of water users, users may not effectively implement it. Therefore, water users need to be involved in the decision making process during formulation of the plan.

First, requests from water users should be surveyed before the plan is drafted. The following points should be addressed: (i) the area of land farmers want to irrigate, (ii) the kind of crops water users plan to grow, and (iii) the start date of irrigation. A Water Users' Association (WUA) meeting is useful for collecting such information.

Next, the draft of the plan needs to be approved by water users. For this purpose, meetings with representatives from the WUA and local government staff are held. The draft plan is presented with explanations of how it was prepared. The draft is revised if necessary and needs to be approved at these meetings.

The finalised plan should then be announced to all water users.

### **Estimation of available water and water demand for irrigation**

*To estimate available water and water demand in the coming irrigation season, the present volume of available water in reservoirs, for example, are measured and past meteorological and water-use data are collected. There are several alternatives for estimating available water and water demand.*

Since water allocation is determined by comparing water supply with water demand, water supply and demand for the coming irrigation season need to be estimated before the seasonal irrigation plan is formulated. The maximum flow rate of pumps is compared with the maximum water requirements of the irrigation season in pump irrigation systems and groundwater systems. The minimum flow rates of river and returned flows are compared with water requirements in gravity irrigation systems without storage facilities. In reservoir irrigation systems and low-lying irrigation systems, water supply and water demand are compared during the entire irrigation season. Maximum flow rates of canals are also examined in all types of irrigation systems.

First, information on the estimated present water resources and expected water resources in the coming irrigation season is collected. The current water resources consist of the storage volume of reservoirs and ponds, soil moisture in farm plots, and available groundwater. As it is difficult to estimate expected water resources correctly, historical records are used instead. Records to be reviewed include past levels of rainfall, discharge into reservoirs or at intake points, and evapotranspiration.



*Safe and risky estimation methods*

There are several alternative methods for estimating available water resources and effective rainfall, both of which are essential elements to estimating water requirements (Table 2.2).

1. Neglect future rainfall into and discharge from reservoir or river systems

This estimation, although the safest option, is the most pessimistic as it only uses the present storage in reservoirs as the measure of available water resources. Consequently some agricultural production may be lost.

2. Use past average amounts of rainfall and river flows to estimate effective rainfall and available water resources

This is the most optimistic option, yet risky because it does not take into account the fluctuations of the water supply. This method allows for optimal agricultural production in an irrigation system. If a seasonal irrigation plan is established on the basis of this method, a contingency plan should be prepared in case of lower than expected rainfalls or river inflows.

3. Use minimum values or values with a return period for expected rainfall and river flows.

This third estimation method calculates river inflow based on return periods that is the time interval between water resource related events such as a drought. In seasonal irrigation planning the drought return period is considered. For example, if effective rainfall is calculated by assuming a 10-year drought return period, then the plan will likely fail only once in 10 years.

Table 2.2 *Estimation of water resources*

	Estimated inflow into the reservoir	Effective rainfall
Safe option	No inflow (Only present reservoir storage is estimated as available water volume)	0
↓	Use previous records of drought year or other years to estimate inflow	Values estimated on basis of return periods of drought or other events
	Average inflow into a reservoir	Values estimated on basis of average rainfall
Risky option		

**Constraints on irrigation**

*The seasonal irrigation plan is determined after comparing estimated available water and irrigation water demand so that the former should not be less than the latter at any time during the coming irrigation season. Crops cultivated, area irrigated, crop establishment, and starting date of irrigation will be limited or controlled if the water supply is inadequate.*

Estimated available water and water demand for irrigation are compared to draw up the seasonal irrigation plan, as mentioned above. If the former is lower than the latter at any period in the next irrigation season, irrigation may fail. If the water supply is inadequate for irrigation, constraints may be placed on the crop cultivated, area irrigated, rice establishment method, or starting date of irrigation.

#### *Area irrigated*

Restrictions on the planting area may prevent excess cropping and, as a result, reduce the water deficit. This restriction seems to be useful for dry season crops and is often applied in practice.

Water allocation and thus acceptable irrigation area is determined by comparing water supply and demand as in the following equation:

$$\text{Acceptable irrigation area} = \frac{\text{Estimated water resources} - \text{Water demand for other purposes}}{\text{Irrigation demand per unit area} - \text{Estimated effective rainfall}}$$

#### *Crops cultivated*

Rice is the prevailing crop in the LMB and is suitable for cultivation in the rainy season. It requires much more water than other crops and water shortage in the rainy season may restrict its cultivation. Therefore if there are other suitable crops, they could be considered for cultivation in the paddy fields under the seasonal irrigation plan.

#### *Method and starting date of rice establishment*

There are many rice establishment methods: transplanting, dry direct seeding, wet direct seeding, and water direct seeding. Transplanting, wet direct seeding and water direct seeding require large quantities of water at the beginning of the irrigation season, whereas dry direct seeding uses less water than the other methods. If the farmers' cultivation technology is only suitable for dry direct seeding, use of other methods may be restricted to save water. However, other aspects such as yield need to be examined and sustainable methods selected for the seasonal irrigation plan.

In the rainy season, rice crop farms rely on rainfall to meet water requirements. Rainfall at the beginning of the rainy season is particularly important for supplementing water requirements for land preparation or pre-saturation. However, the starting time of the rainy season is sometimes delayed. In such cases, rice establishment should be postponed as a countermeasure.

However, the decision to take this action should be carefully considered because it is desirable to maintain regular irrigation periods over the year (see page 15).

### Allocation of area irrigated

*When the amount of available water is not sufficient for farmers to irrigate all of their crops, the area of irrigation or the cropping area must be limited. These limitations have to be imposed on all farmers involved. On the other hand, it is desirable to converge irrigated areas to reduce non-productive consumption of water. In the application of these limitations and convergence, the social background of the irrigation project should also be taken into consideration.*

Both convergence and equity should be considered when allocating the irrigated area when the total irrigated area in the system should be constrained because of insufficient water resources. These actions sometimes conflict with each other, although they are important for achieving highly efficient irrigation.

The term ‘convergence’ refers to the convergence of irrigated areas as parts of the irrigable area in order to directly decrease water losses. The term ‘equity’ refers to the allocation of irrigation opportunities in a way that is fair to all water users. Equity, however, does not lead to an increase of irrigation efficiency, but it can encourage farmers to carefully manage their water.

### Convergence of irrigated areas

Available water resources are occasionally not sufficient to irrigate all the irrigable area of an irrigation system. In such a case, the area irrigated is restricted to certain parts of the irrigable area.

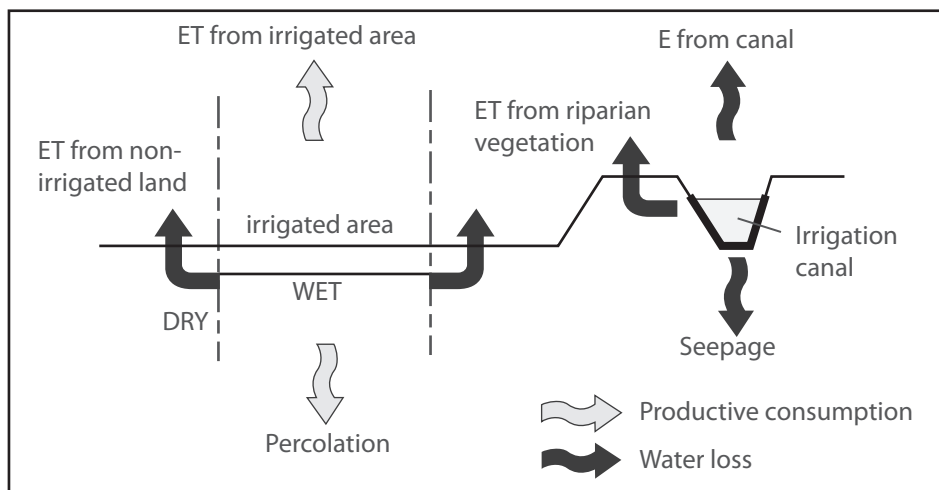

Figure 2.2 Water losses occurring along the boundaries of irrigated areas and canals

Because water losses occur along the boundaries of irrigated areas (dotted lines in Figure 2.2) and irrigation canals (thick lines in Figure 2.2), it is important to limit the distance of water flow by decreasing the length of canals and reducing farm boundaries.

Figure 2.3 presents both scattered and converged irrigated areas having the same total surface area. The converged irrigated area needs shorter canals and has shorter boundaries than the scattered irrigated area. Therefore, converged irrigated areas have a higher irrigation efficiency and are advantageous when only parts of an irrigable area are to be irrigated.

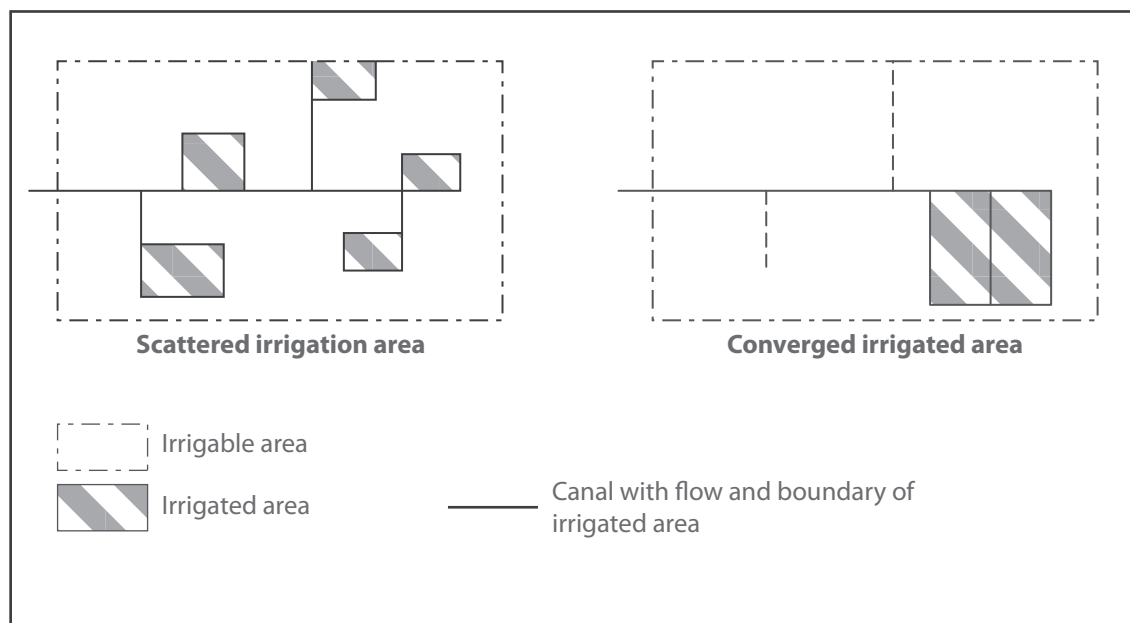

Figure 2.3 Schematic diagrams of scattered and converged irrigation areas

#### *Equity in assigning irrigated areas to water users*

If farm plots situated upstream were given delivery priority in an irrigation system where restrictions apply, farmers upstream would have higher crop intensities, an advantage likely to create inequity among water users. Inequity dissuades water users from participating sincerely in proper water management; seasonal irrigation plans may not be respected and vandalism such as water theft may occur. Consequently, irrigation efficiency would decrease.

To prevent this kind of situation, the areas irrigated within an irrigation system should be shuffled every irrigation season in order to maintain equity among water users. This method is particularly relevant when a chronic water deficit is identified (Figure 2.4). Sometimes, seasonal rotations are implemented among tertiary or secondary canals. This may result in scattering the irrigated areas, which, as mentioned before, should be avoided. Rotations must therefore be implemented between, but not among, tertiary canals and/or secondary canals.

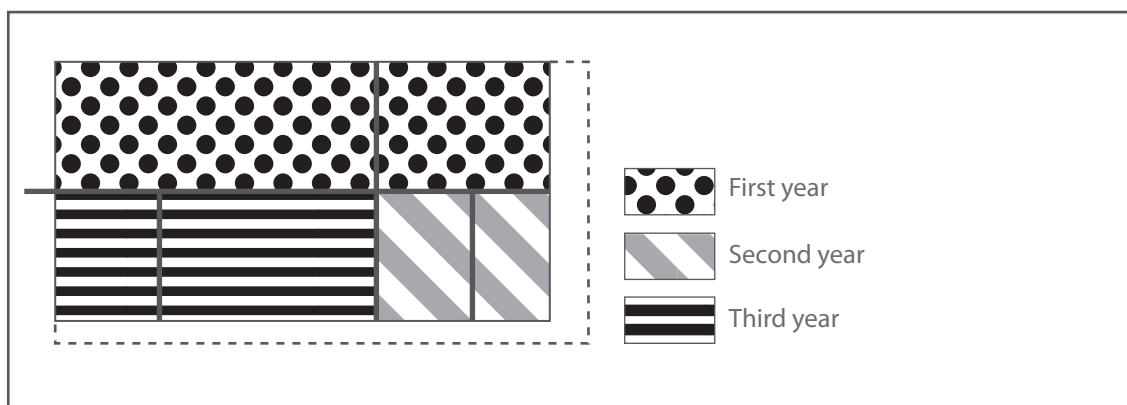

Figure 2.4 Rotation of irrigated area

### Irrigation period in a climate cycle

*It is ideal to fix approximately a cropping period and an irrigation period so as to help water users to stick to a seasonal irrigation plan, although the exact dates of these periods should be decided every irrigation season after consultation with water users.*

The irrigation period of the seasonal irrigation plan is determined after consideration of social and meteorological aspects. The availability of water is a crucial element in tropical monsoon regions, where rainfall is unevenly distributed over the year. The irrigation period should be fixed in the climate cycle in a way that makes the most of rainfalls for effective water use.

As an example, irrigation period and monthly precipitations in one irrigation system are shown in Figure 2.5. Two irrigation periods are planned to fall during rainy months in order to minimise irrigation demands in a double-cropping area.

However, the availability of water is not the single determining factor. Other factors, such as temperature, solar radiation, rainfall in the harvest period, and labour market, are taken into consideration when deciding on the timing of the irrigation periods.

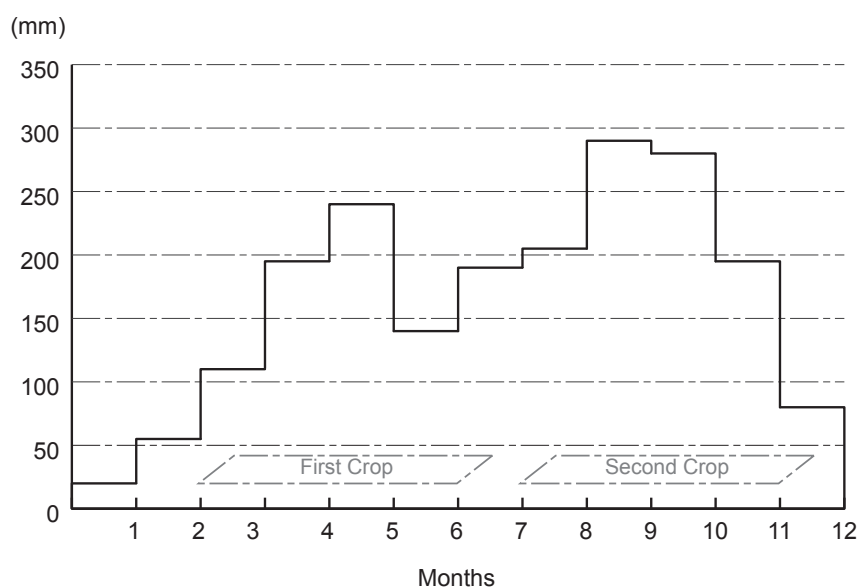

Figure 2.5 Rice growing periods and monthly precipitation in Muda, Malaysia (Yamaoka *et al.* 2004)

It is also important not to extend the irrigation period, for it leads to low irrigation efficiency. Water supply should be discontinued when the planned irrigation period has finished. This interruption should be performed strictly to make water users follow the irrigation period that has been decided.

### Distributed and concentrated starts of the irrigation period

*All farm plots under one tertiary canal should start irrigating simultaneously to reduce the irrigation duration, whereas sub-systems of the whole canal system should try to spread their start dates to reduce peak water requirements during land preparation at the irrigation project level.*

One effective measure for reducing irrigation water losses and increase irrigation efficiencies is to shorten the irrigation period, as some kinds of water loss depend mostly on the duration of water flow rather than its flow rate (see page 28). A shorter duration of water supply may contribute to higher irrigation efficiencies.

One of the methods used for shortening the duration of irrigation consists of introducing varieties with short growth periods. However, the method discussed in this guidance is the coordination of crop establishment dates among farmers. The duration of irrigation may indeed be extended if farmers of an irrigation system delay their planting (Figure 2.6). The spreading of planting dates could be prevented by:

1. Considering individual conditions to determine the irrigation period.

Farmers delay their planting for specific reasons. They may have a busy schedule on the start date or may not be able to start a new cropping term because the previous crop was harvested late. Such circumstances should be surveyed and considered when a seasonal irrigation plan is established.

2. Full understanding of the irrigation plan by all water users.

All water users should fully comprehend the irrigation plan. It can be achieved through announcements and sub-group meetings, both of which are important.

3. Strict and punctual supply of water only during the planned irrigation period.

Providing water beyond the planned period should be prohibited to make water users comply with the irrigation plan.

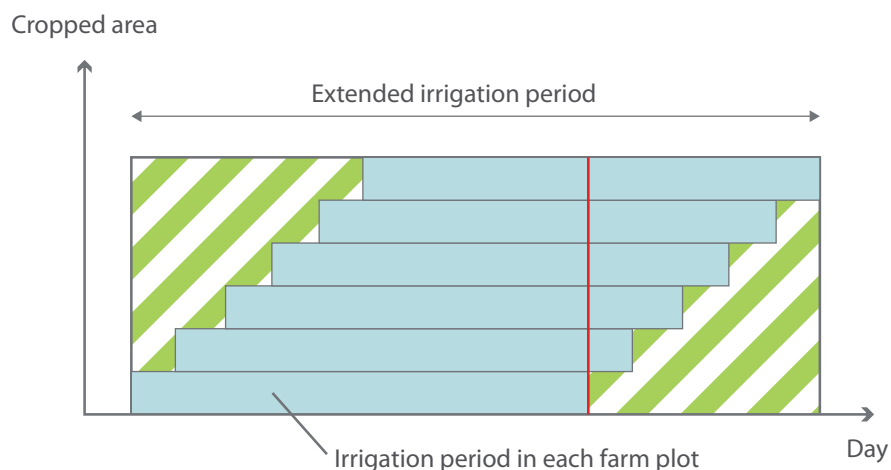

Figure 2.6 Extension of the irrigation period induced by delayed crop establishments

In contrast, a coordinated start of irrigation causes another problem in that water requirements in paddy fields are much larger at the beginning of the irrigation season than at other periods. A large amount of water is required for land preparation, pre-saturation, and transplanting at the start of the irrigation period. The standard canal design does not fit this extreme water demand. The start of irrigation should consequently be distributed in order to cut the peak demand in this case (Figure 2.7, Figure 2.8).

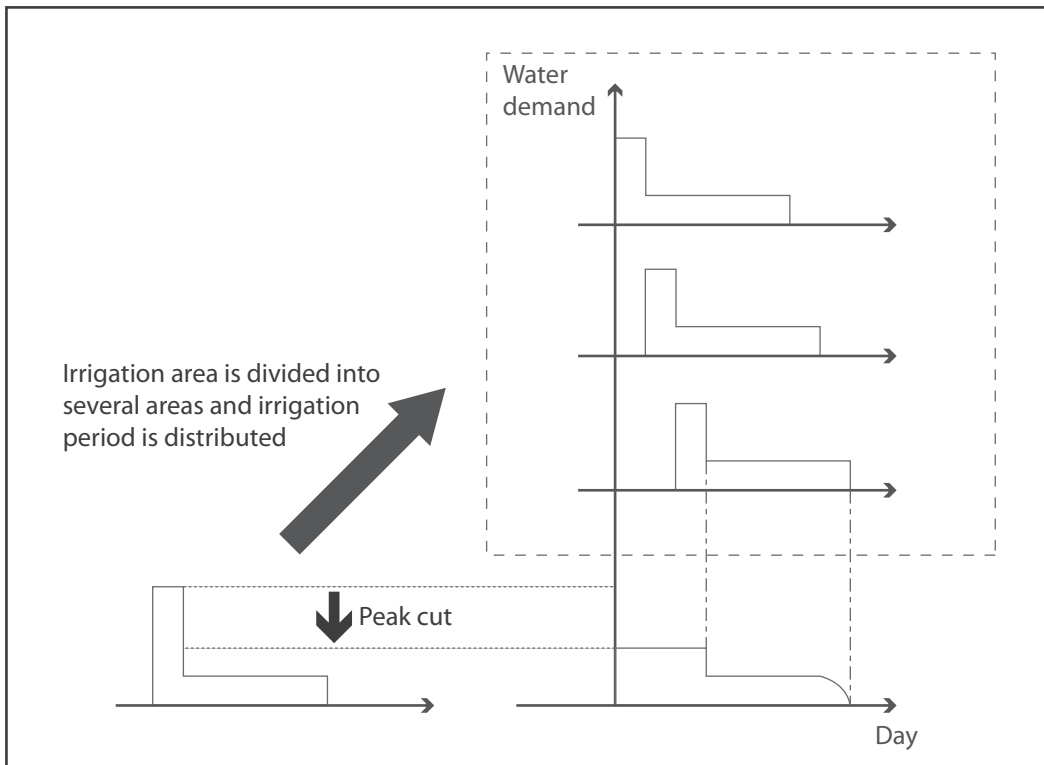

Figure 2.7 Effect of a distributed irrigation period on the peak demand of water at the start of the irrigation period

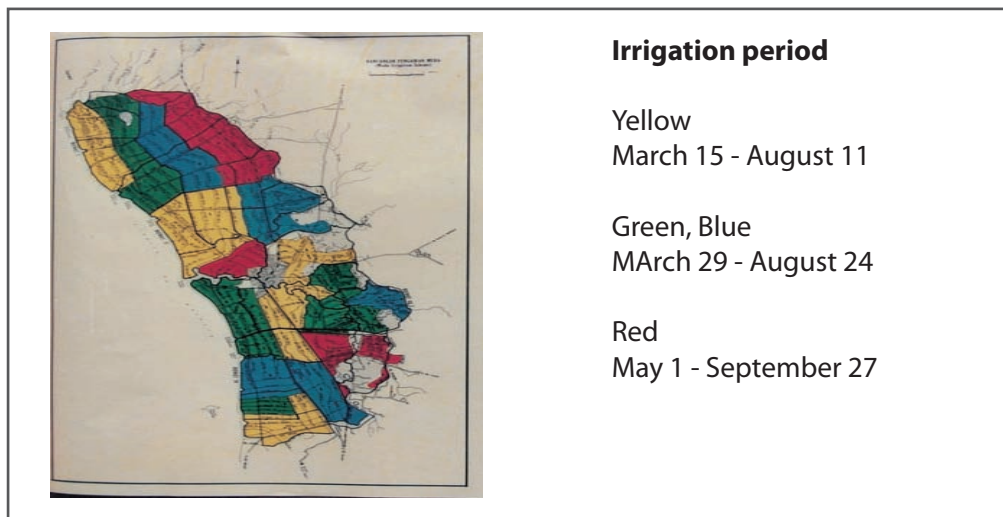

Figure 2.8 Example of a distributed irrigation period (Nanbu, 2002)

In conclusion, setting the start date of an irrigation period is crucial and start dates should, in general, be distributed over the whole irrigation system but coordinated between farm plots supplied by the same tertiary canal.



## Water allocation planning in a reservoir irrigation system

*When a reservoir has a storage capacity exceeding the demand for a single irrigation season, the variation of reservoir storage is estimated so as to cover longer periods of irrigation.*

When the storage capacity of a reservoir exceeds the demand for a single irrigation season, the reservoir can be expected to be used for two or more irrigation seasons. Water storage is allocated to each season in a way that optimise the total agricultural production or practically the total irrigation area. If reservoirs are intended for multiple uses, water storage is allocated to each purpose.

The analysis of optimal reservoir operation (for example, by dynamic programming) is useful for solving this problem.

### *Dynamic programming*

Dynamic programming (DP) is a method used to automatically find a seasonal irrigation plan that can generate the maximum benefit for all stakeholders under given conditions. An evaluation function is used as an index of benefit. The main drawback of DP is the amount of calculations required. However, many modifications, such as the Discrete Differential Dynamic Programming (DDDP) have been proposed to reduce the steps needed for calculation.

There are two major types of DP: deterministic and stochastic. If we can forecast the future inflow or demand, then deterministic DP can be used. However, as forecasting hydrological conditions over a long period is difficult, stochastic DP is used to determine the principles of optimum reservoir operation.

Storage of reservoirs, release from reservoirs, and inflow into reservoirs are elements used for DP. These factors are analysed in several periods and are converted into discrete values. Because the calculations are executed recursively, the values of the evaluation function for each period are set up as initial conditions in every storage unit. The evaluation function deals with the optimum objectively and uses the storage as an independent variable. Evaluation functions are shown as follows by continuous equations:

$$f(S_i) = \max_{R_i} \left( \sum_{I_i} P(I_i)(g(R_i) + f(S_{i+1})) \right)$$

$$S_i + I_i - R_i = S_{i+1}$$

Where:

P (I<sub>i</sub>): Occurrence probability of inflow I<sub>i</sub> at period i

R: Release from reservoirs

I: Inflow into reservoirs from catchments

g(R): Function that is dependent on benefit resulting from water release

S: Storage

f(S): Evaluation function

## **Water allocation plans for low-lying irrigation systems**

Water can be distributed evenly if an irrigation project area is very flat and canals have enough capacity. In this case, target water levels, rather than canal flow rates, are decided at some points and in some periods. A target water level is determined according to the overall situation in which the irrigation project is applied. Floodwater intrusion and water consumption over the area are particularly important factors in determining a target water level.

### *Features of irrigation systems in low-lying areas*

Some irrigation systems store water in canals to irrigate farm plots. These types of system can operate by tidal irrigation, creek irrigation, storage irrigation, colmatage system, or submerged irrigation. Water is controlled by checking stored stocks instead of flows in these irrigation systems. Dikes with gates usually surround the irrigation scheme, and canals are used as reservoirs. Once water comes into the area, only a gate operation can drain the water stored.

This irrigation system can reduce water delivery losses and achieve high irrigation efficiency because supplied water does not leave the irrigation system as surface flow (see water spilled and drained from farm plots; Figure 1.2). These flows return into the canal system and are reused later.

The target water level has to be between the level that avoids inundation damage in the lowest plots and the one that affords water lifting to the highest plots without or with the minimum amount of pumping (Figure 2.9).

Because water is reused in this irrigation system, high irrigation efficiency is theoretically attained. Conversely, it is difficult to operate the canals (see page 48) in a way that keeps the appropriate water levels at each point in the system because the operation of a gate may influence water levels of many other points in remote canals.

Tidal and flood-prone are two basic types of irrigation system found in low-lying areas. The seasonal irrigation plan for the dry season should be carefully examined in the tidal system, while the irrigation plan for the rainy season needs more attention in a flood-prone system.

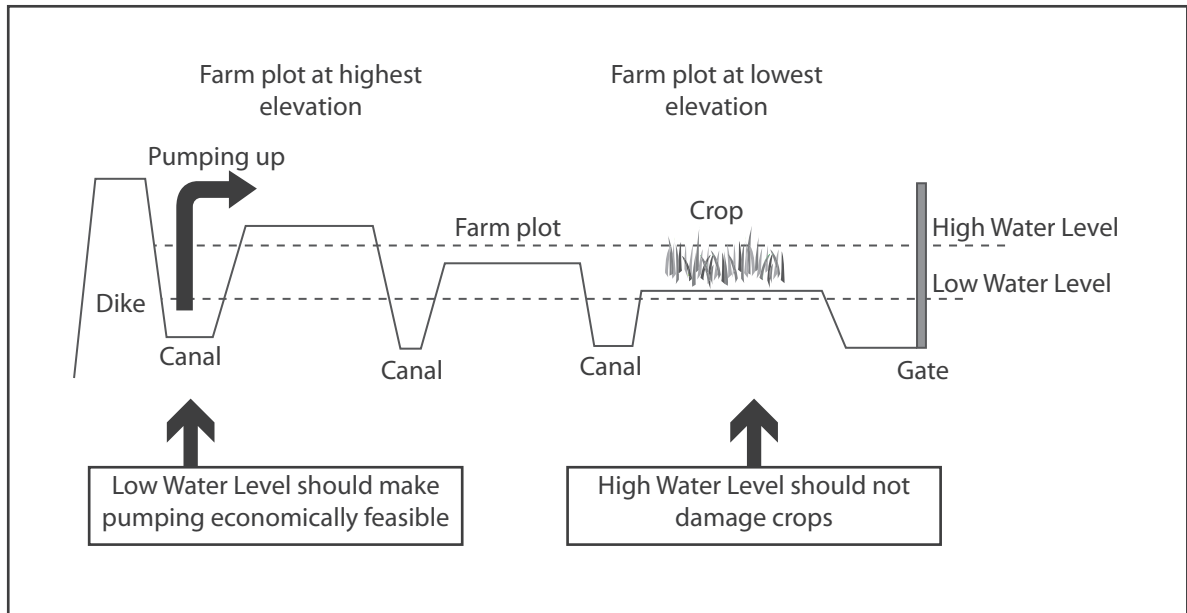

Figure 2.9 Control of water level in low-lying areas

*Water allocation in tidal irrigation systems during the dry season*

Tidal irrigation systems use canals as reservoirs. In these systems a seasonal irrigation plan is more important in the dry season, as no additional water supply to the system is expected. Because the available water in a canal system is sometimes the only water storage at the beginning of the dry season, estimating water requirements for crop fields is not enough to make up a plan (Figure 2.10). In this case, the gross consumption of water in the basin should be estimated; this includes groundwater movements such as seepage through dikes surrounding the irrigation scheme, evaporation from the water surface in canals, and evapotranspiration from non-agricultural lands.

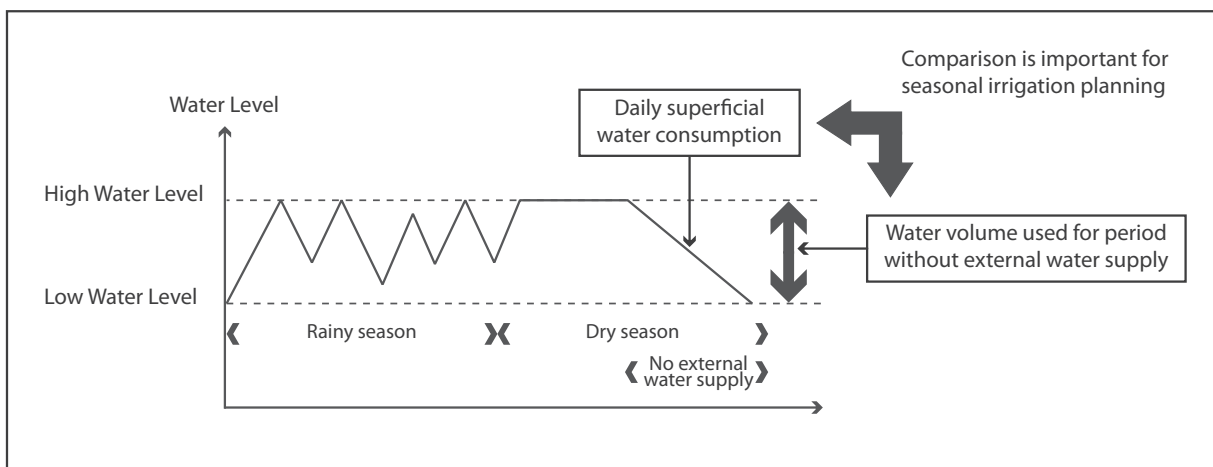

Figure 2.10 Shifts in water level in a tidal irrigation system

– The basin water balance method

The basin water balance method can be applied to the estimation of gross water consumption in basins fed by irrigation. The basin water balance is expressed by the following equation:

$$[\text{Rainfall}] + [\text{Irrigation supply}] = [\text{Evapotranspiration}] + [\text{Runoff}] + [\text{Seepage}] + [\text{Storage change}]$$

Evapotranspiration and seepage are difficult to measure directly in low-lying areas. Seepage (groundwater movement) is affected by the difference between the water levels within and outside the irrigation system, and is estimated by measuring water balances or analysing records of water level observations taken over a long period. An estimation of the basin water consumption is important to establish a seasonal irrigation plan. Water consumption is composed of evapotranspiration and seepage, but they are not distinguished in the following modified equation:

$$[\text{Estimated basin-wide gross water consumption}] = [\text{Rainfall}] + [\text{Irrigation supply}] - [\text{Runoff}] - [\text{Storage change}]$$

If the changes in soil moisture and groundwater levels can be neglected, the change in storage is measured as the water level change in the canals.

Figure 2.11 shows an example of estimated gross water consumption in each irrigation sub-system using the water balance method during a non-rainy period.

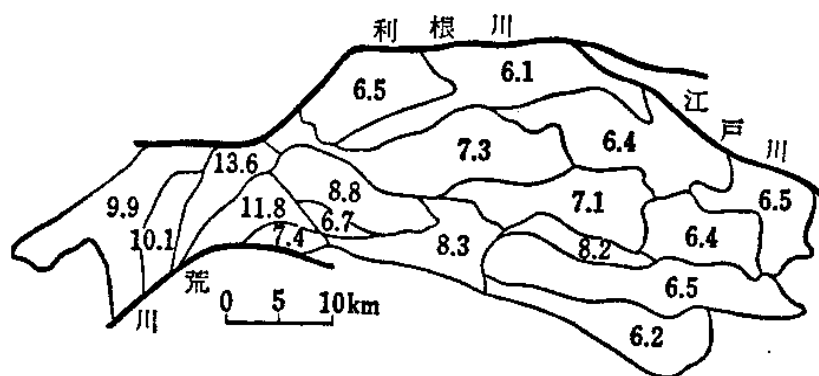

Figure 2.11 Water balance analysis (Kaneko, 1973)

Left: Topography of target area; Right: estimated gross water consumption (mm/day)

This low-lying irrigation system is surrounded by three rivers and divided into sub-systems by dikes. Gross water consumption of each sub-system is estimated by the basin water balance method. The amounts of irrigation supply and drainage canals are surveyed by simultaneous measurements and rainfall is neglected.

*Water allocation in flood-prone irrigation systems during the rainy season*

Floodwater is used as an external water source in some irrigation systems in Southeast Asia. The colmatage system found in Cambodia is a typical example. Gravity irrigation systems with weirs have also been developed to control water level so as to use floodwaters effectively (Figure 2.12). Thus water level is controlled according to the stage of rice crops and floodwater levels need to be estimated to establish a seasonal irrigation plan.

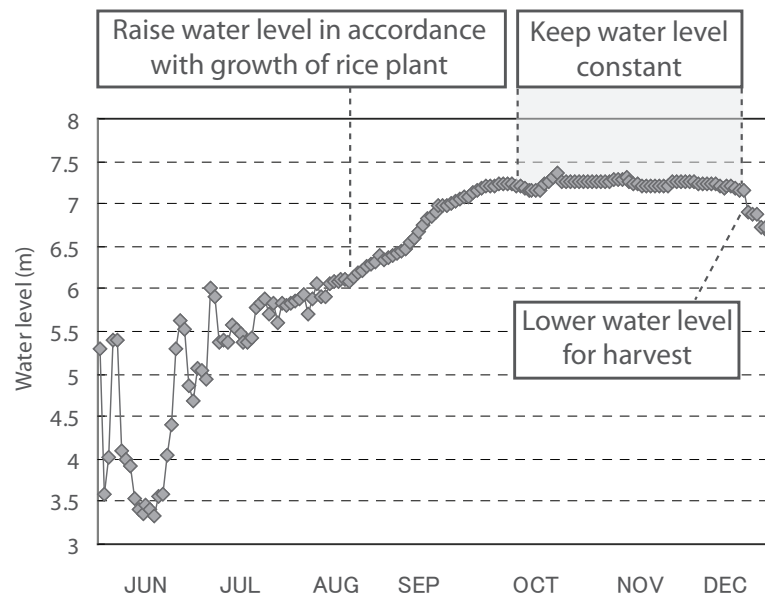

Figure 2.12 Change of controlled water level in a flood-prone irrigation system

In this irrigation system, estimation of floodwater intrusion is important. If the floodwater entering the system is overestimated and rice is being cropped at relatively high elevation, water could be insufficient. On the other hand, if the intrusion is underestimated and a variety with short culms is cropped, there could be severe flood damage. In the seasonal irrigation plan, the cropping period or target water level in the irrigation system need to be regulated in accordance with the degree of floodwater intrusion.

Water balance methods can be used to estimate floodwater intrusion using the following equation:

$$[\text{Rainfall}] + [\text{Irrigation supply}] + [\text{Floodwater intrusion}] = [\text{Evapotranspiration}] + [\text{Drainage}] + [\text{Storage change}]$$

The level of water storage in the system is a key element in this estimation. A volume–water stage curve is prepared for the estimation. Figure 2.13 shows an example of estimated floodwater intrusion. From these data the monthly floodwater intrusion is estimated.

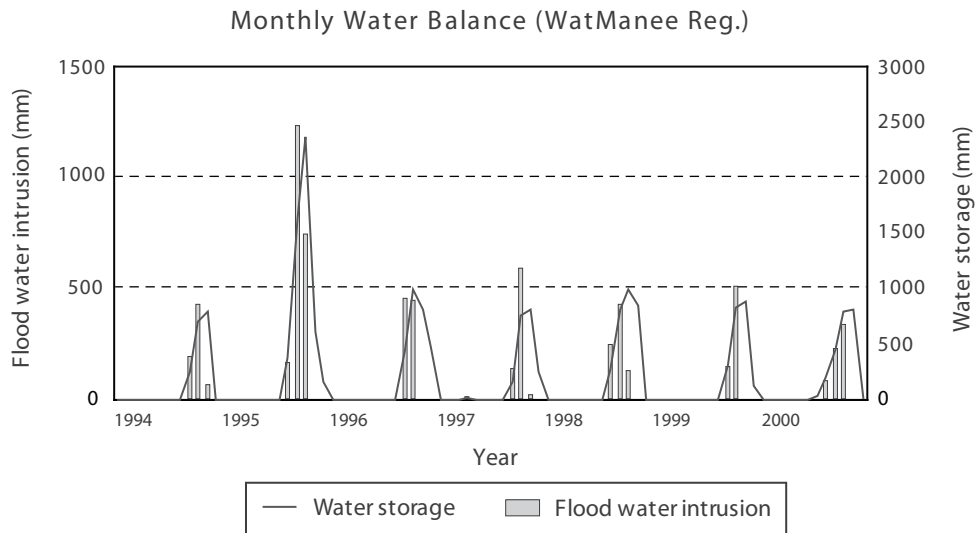

Figure 2.13 Estimation of water intrusion in an inundated irrigation area

### 3. Irrigation scheduling and facility operations

#### 3.1 Outline of irrigation scheduling

*Water supply is estimated for a given period, reflecting changes in water demand, climate, and other related factors. Irrigation scheduling determines the water supply to all canals.*

#### **Irrigation scheduling and flexible water distribution**

Irrigation scheduling occurs during the irrigation season and consists of determining when and where to irrigate and how much water to use for irrigation. On the other hand, a seasonal irrigation plan (see section 2.1) is created before the irrigation season and estimates the water volume that will be supplied in each period. Water requirements depend on rainfall, evapotranspiration, crop growth rate, water management, and also include the water previously supplied to each farm plot. The distribution of irrigation water is determined in daily, weekly, or monthly irrigation schedules. The features of seasonal irrigation planning and irrigation scheduling are compared in Figure 3.1.

Seasonal Irrigation Planning	Irrigation Scheduling
Planned once before the irrigation season starts	Planned many times during the irrigation season
<div style="display: flex; justify-content: space-around; align-items: center;"> <div style="border: 1px solid black; padding: 5px; width: 150px;">Present water storage</div> <div style="border: 1px solid black; padding: 5px; width: 150px;">Estimated runoff, rainfall, ET...</div> <div style="font-size: 2em;">➔</div> <div style="border: 1px solid black; padding: 5px; width: 150px;">Water requirements and water supply (volume)</div> </div> <p style="margin-top: 20px;">For the whole irrigation system or several sub-systems</p>	<div style="display: flex; justify-content: space-around; align-items: center;"> <div style="border: 1px solid black; padding: 5px; width: 150px;">Water requirements and water supply (volume and <u>timing</u>)</div> <div style="font-size: 2em;">➔</div> <div style="border: 1px solid black; padding: 5px; width: 150px;">Present water storage</div> </div> <div style="display: flex; justify-content: space-around; align-items: center; margin-top: 10px;"> <div style="border: 1px solid black; padding: 5px; width: 150px;">Measured runoff, rainfall, ET...</div> <div style="border: 1px solid black; padding: 5px; width: 150px;">Surveyed water condition in farm plots</div> </div> <p style="margin-top: 20px;">For each tertiary canal</p>

Figure 3.1 Comparison between seasonal irrigation planning and irrigation scheduling

Water requirements vary every day, so the water supply should change accordingly. In this respect, irrigation scheduling is an effort to adjust water supply to meet water demand and increase the irrigation efficiency by avoiding water deficits in farm plots (Figure 3.2).

Irrigation water is supplied at a constant flow in some irrigation projects. This practice can reduce labour input, but its lack of flexibility generates big water losses and a lower efficiency.

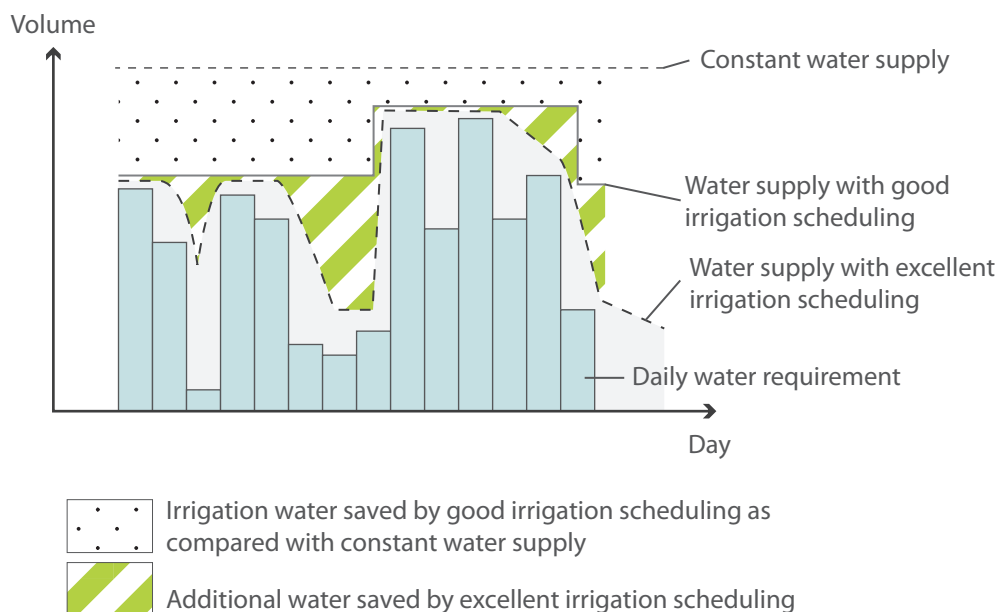

Figure 3.2 Water supply determined by irrigation scheduling

A good control of water supply in an irrigation system depends on the ability of irrigation scheduling to reflect real water requirements. A flexible water supply can save large amounts of water (hatched and dotted areas).

It is desirable to carry out irrigation scheduling daily in order to increase the irrigation efficiency. The frequency of irrigation scheduling may be decreased if it requires too much labour, but it should still be performed at least twice a month. If water is supplied intermittently, the distribution will need to be examined for each unit period.

Furthermore, irrigation scheduling should be performed at regular intervals. Water users may not notice changes in irrigation schedules if the changes are made at irregular intervals. In case of heavy rain, the schedule should, however, be changed with no hesitation. In such cases, stopping the irrigation immediately may save water without confusing water users.



## Procedure for water distribution

The process of water distribution has several steps: monitoring, decision making for irrigation scheduling, schedule announcement, canal operation, and recording data on canal operations.

### *Monitoring*

Information for irrigation scheduling mentioned earlier should be collected to make an appropriate water distribution plan. At this stage, requests from water users should be considered. WUAs can help collecting wishes from water users and avoid excessive requests from particular individuals.

### *Decision making*

Information collected in the monitoring phase is used to determine irrigation scheduling. A canal operation plan should also be established at this time (see section 3.4).

### *Announcement*

Water users should be informed of irrigation schedules. Different actions are taken to inform them, such as WUA meetings, local public announcements and bulletin boards (Figure 3.3).



Figure 3.3 Bulletin board informing water users in each sub-irrigation system of the water delivery rotation at irrigation turnouts

### *Gate operation*

Gate operation is explained in Section 3.4.

### *Recording data on canal operations*

Operational data for water management should be recorded at cross-regulators and turnouts, spillways, intake points, and other water management structures when they are operated or observed. Such data includes the degree of gate or valve opening, water levels upstream and downstream, water flow status (free, submerged, or merged), time of operation, number of gates operated, and diverted and passing flow rates. Rainfall, water supply and flow into reservoirs, river flow at intake points, and flow in drainage canals should also be measured. Standing water depth in the field, crop stage, and actual crop area could as well be useful information for irrigation scheduling.

The records mentioned above are used for daily operations or to improve future irrigation plans (see section 6.1).

## 3.2 Key issues to improve irrigation scheduling

### **Continuous and intermittent water supply**

*The two types (intermittent and continuous) of water supply will be compared in this paragraph. In general, intermittent (on-off) irrigation reduces water loss in tertiary canals while continuous water supply is better adapted for main canal operations.*

There are two methods used to control the volume of water in an irrigation system: by flow rate or by flow duration. In this guidance, the former is called ‘continuous supply’ and the latter ‘intermittent supply’.

Continuous supply is illustrated on the left in Figure 3.4. In this method, water is supplied continuously and the volume supplied is controlled by regulating flow rates. By contrast intermittent supply (on the right in Figure 3.4) presents a constant discharge and the volume supplied is controlled by stopping and starting the water supply. This is also called ‘rotational water supply’.

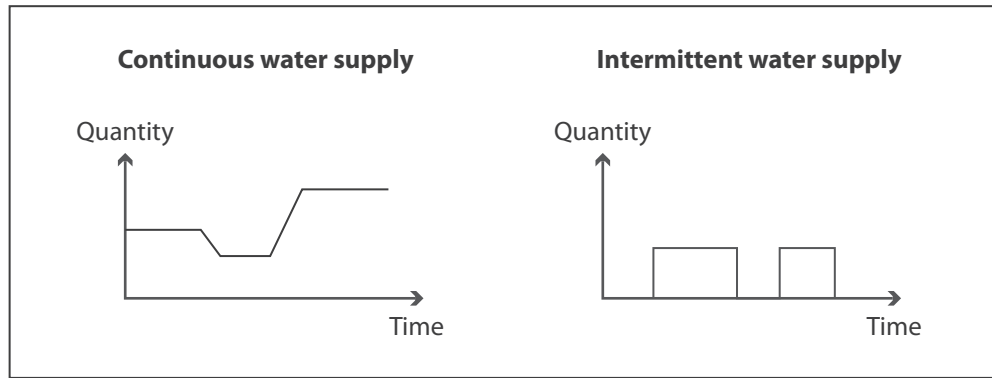

Figure 3.4 Comparison of flow in continuous and intermittent water supply methods

Part of the water loss of an irrigation system is constant regardless of flow rate, but the rest is proportional to the flow rate in the canal. This indicates that irrigation efficiency is low at lower flow rates (Figure 3.5). It is thus preferable to discharge a large amount of water in a short time to achieve high irrigation efficiency. For this purpose, an intermittent water supply is more appropriate. Many other factors should be examined nonetheless to decide which method should be used in each irrigation system and/or each irrigation canal. These factors include the flow of maintenance water, presence of cross-regulators, travel time of irrigation water, uplift pressure in canals with thin linings, multiple water uses, vandalism such as water theft, and measurement practices. These factors are explained later in this section.

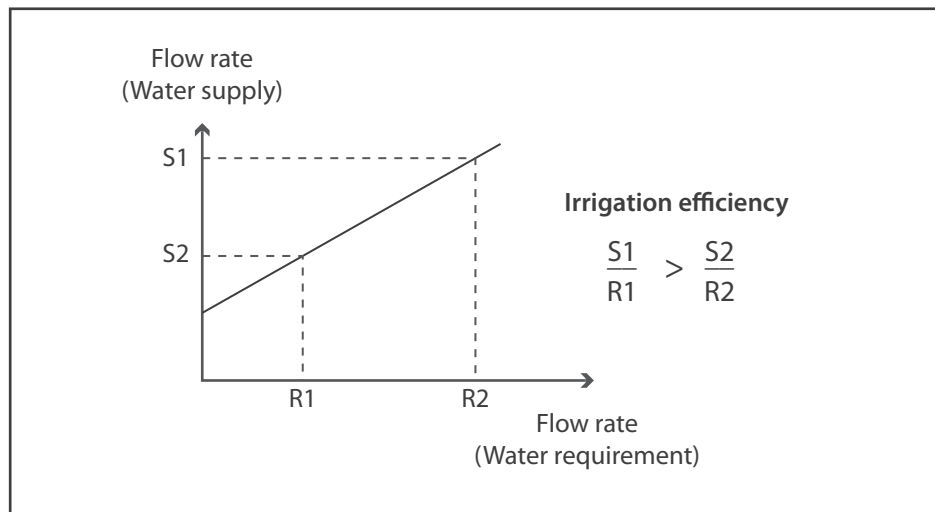

Figure 3.5 Variation of the irrigation efficiency depending on the amount of water supplied

### *Maintenance water*

Maintenance water is additional water diverted into a canal system to meet water requirements of the irrigation system. Typically, appropriate water levels are maintained at specific canal turnouts in order to divert water. Because irrigation canal systems use the most frequent or maximum flow rate as a reference for design, some turnouts may not be able to divert enough water to branch canals when the flow rate is lower than the reference value. In such cases, additional water needs to be supplied to the canal system so as to keep the water level high in the canals. This additional water is not used in farm plots, but it spills out from the canals or drains out from the farm plots. Maintenance water is required for water delivery, but does not contribute to crop production. Therefore, reducing the amount of maintenance water used will help improve the irrigation efficiency. A cross-regulator (see sections 5.2, 5.6) is sometimes installed to maintain the level required for diversion without using additional water. Another option is to divert only the design flow rate. With this method, water volume should be controlled in time, so water supply should be intermittent.

### *Advantages and disadvantages of supply methods in terms of water management*

Water storage in canals serves several functions. One is to reduce travel time (time lag), as the water needs time to reach its destination. Long travel times make canal operations difficult. They are nonetheless required in empty and long canals, because the vacant space must be filled as the water runs through the open channel. Therefore, water should always be stored in the canals to reduce travel time. Intermittent supply creates vacant space in the canal system, resulting in longer travel times, while continuous supply does not have this problem and allows for shorter travel times.

Another function of water flows in canal systems is to cope with uplift pressure in canals with thin lining. As a result, intermittent supply may cause problems in such irrigation systems.

An irrigation system also has multiple functions and may be used for other purposes, such as domestic water supply. In such a case, the water flow cannot be terminated and only a continuous supply is suitable.

Vandalism such as water theft may occur in some irrigation systems. Some water users may take water from a canal system to their own farm plots without permission. Intermittent supply is an effective way to prevent this type of vandalism.

Continuous supply allows the use of various flow rates in a canal system, so it requires more advanced control facilities and an accurate measurement system. On the other hand, intermittent supply facilities require only simple on-off controls and a simple measurement system (Figure 3.6).

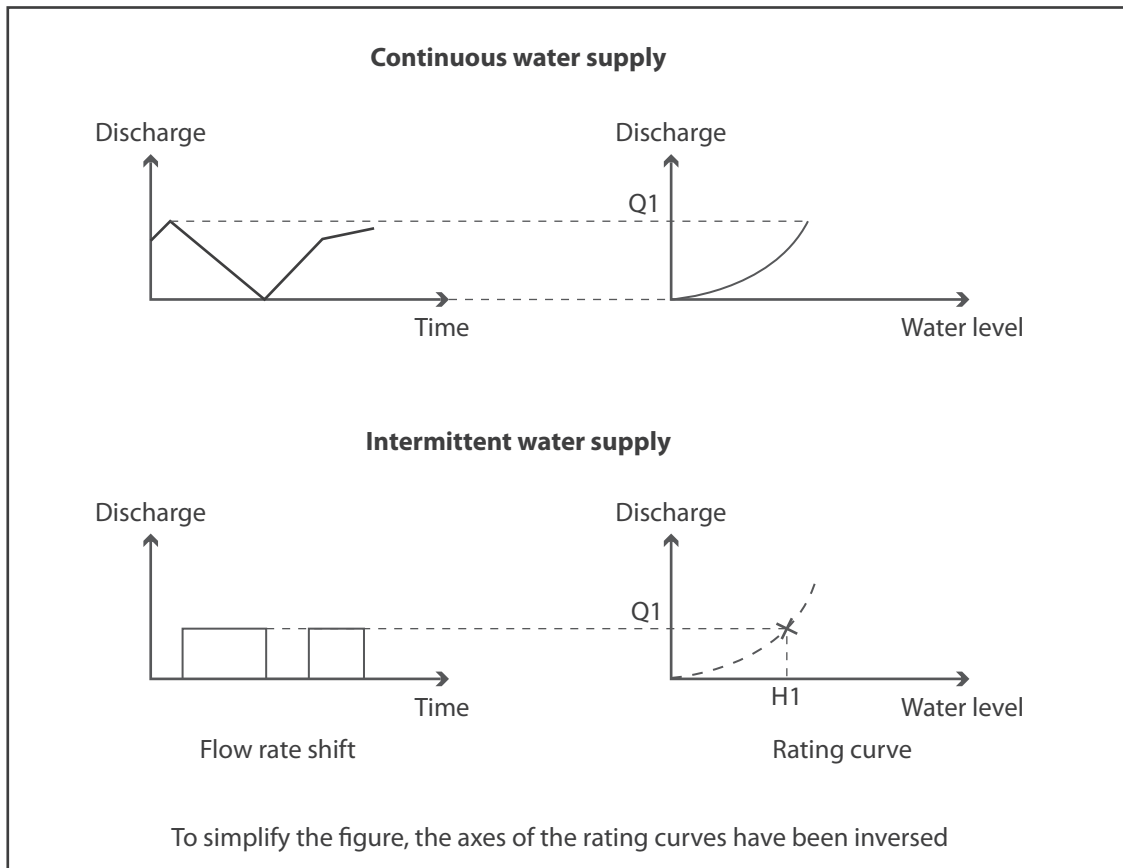

Figure 3.6 Estimations of flow rates in continuous and intermittent supply methods.

With a continuous water supply, a rating curve should be created to estimate flow rate from water level. With an intermittent water supply, however, only several measurements of the relationship between flow rate and water level are needed.

*Comparison of the two supply methods*

The features of the two methods and suitable irrigation canals for each method are summarised in Table 3.1. An appropriate method for irrigation canals should be selected when formulating the water distribution plan. Both methods may be employed in the same irrigation system.

Table 3.1 Comparison of continuous and intermittent supply methods

	Features	Suitable irrigation canal
Continuous supply	Control by flow rate Flexible More accurate/smart system required	Canals with thin lining Long canals Canals serving multiple uses Main canals
Intermittent supply	Control by flow duration High irrigation efficiency and equity expected, even under poor management	Poorly monitored canals Canals affected by vandalism Canals with poor control systems Tertiary canals

## Estimation of water demand

*There are three major ways of estimating water demand for irrigation scheduling: field surveys, calculations using meteorological data, and requests from water users (ordering).*

Irrigation water is delivered through open channels in most irrigation systems in Southeast Asian countries. Irrigation systems including open channels are supply-oriented control systems. Under such systems, water supply cannot adapt according the demand in itself, so water demand has to be estimated in order to establish the irrigation schedule before the water is needed. There are three major ways of estimating water demand (Table 3.2):

1. Field surveys
2. Calculations using meteorological data
3. Requests from water users (ordering)

Table 3.2 *Type and features of different ways to estimate water demand*

Method	Advantages and disadvantages
Field surveys	Accurate but time-consuming
Calculations using meteorological data	Not accurate but easily estimated
Requests from water users (ordering)	Accurate but time-consuming Active involvement of users is needed

### Field survey

With a field survey, irrigation project staff assess factors such as soil moisture and standing water in farm plots and then estimate water demand from the field survey. The estimation is very accurate and is a direct way of judging the need for irrigation, but it is time-consuming and requires many staff members.

Several elements need to be assessed in a field survey (Figure 3.7).

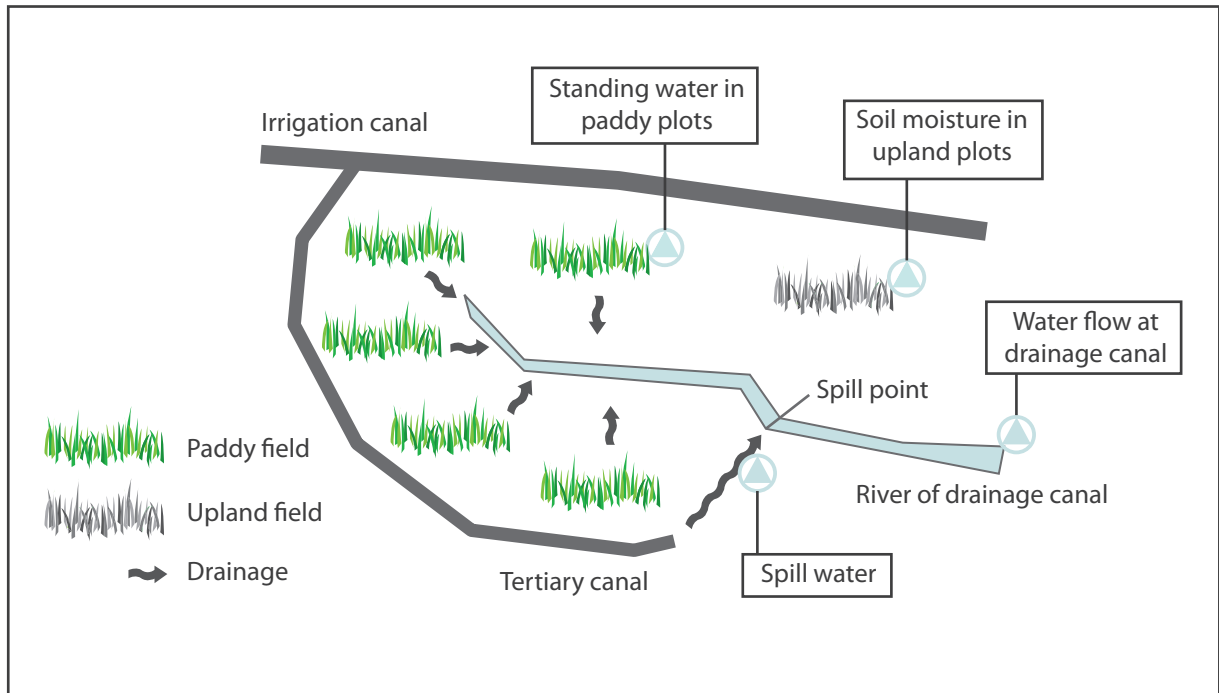

Figure 3.7 Example of factors that can be examined in field surveys

Soil moisture is an important factor to consider before deciding when to apply water in upland fields, but its measurement is difficult for irrigation project staff. Instead, interviews with water users may provide relevant information on the water condition in their fields.

On the other hand, standing water depth is measured in paddy fields to estimate water demand. Water depth is easier to measure than soil moisture, although it is not possible to measure all farm plots and water conditions are likely to differ between plots. Measurements may only cover critical farm plots such as those located far from tertiary canals or those at high elevation on the safe side. Interviewing water users is also a useful method to determine the conditions in paddy fields at the same time.

Soil moisture and standing water depth are crucial elements in estimating water demand with a field survey, but, as mentioned above, they are laborious to collect on a whole irrigation scheme. There are simple and supplemental methods to find excess water supply.

Measurement of drainage flow is an effective method of determining water conditions over a broad area. The presence of high water flows in a drainage canal indicates sufficient or excessive water in paddy fields. This method can be used to estimate the regional water condition, but requires experience in order to establish the relationship between water flow and water condition.

Measurement of water flow at the end of canals or at spill points is used to quantify excess water (spill water) supply to the canal (Figure 3.8).



Figure 3.8 Overflow from a tertiary canal

### *Calculating water demand using meteorological data*

The second method of estimating water demand requirements is to calculate from meteorological data. Meteorological data, such as rainfall and temperature information, are easier to measure than the water conditions in each farm plot. Project staff do not need to perform laborious field surveys; nor do water users need to perform the laborious work required under the ordering system. The accuracy of this method, however, depends on the number of meteorological data-collection points and the method used for calculation.

The calculation method is, in principle, the same as that used for the formulation of the seasonal irrigation plan. One difference being that irrigation scheduling makes use of present rather than historical data, such as rainfall.

Also, unlike seasonal irrigation planning, irrigation scheduling is used to decide on the timing of irrigation. In general, farm plots can store water as soil moisture or standing water, hence water consumption by the farm plot does not directly become water demand. The water stored in farm plots should be considered when the irrigation timing is determined and when water requirements are estimated (see section 6.2).

All related factors (such as evapotranspiration) should be used to estimate water demand. However, a simplified method can also be used to reduce the number of calculations needed. A key factor in water requirement is rainfall, so the depletion of water requirements is determined against rainfall by a simple equation such as follows:

$$S = S_0 - \alpha P$$

Where:

S: Water supply

$\alpha$  : Coefficient

$S_0$ : Water supply in a seasonal irrigation plan

P: Rainfall



*Requests from water users (ordering system)*

With an ordering system, the water supply is scheduled according to the water users' requests. That is, water managers divert water from intakes to main canals and distribute water to each branch canal in accordance with water users' requests. Unlike the second method this one does not need calculations, and unlike the first method it does not need laborious work by staff. Water demand determined by this method is accurate if water users request their irrigation supplies appropriately.

However, there are two main flaws in this method. The first is that the information obtained from water users is generally limited to that gathered when water deficits occur in the farm plots. If there is sufficient or excess water in the canals or paddy fields, water users may not keep the irrigation project staff informed, indirectly causing water loss and lower irrigation efficiency. Although it requires time and effort on behalf of project staff, it is very important to sensitise water users to the influence of frequent communication on saving water. Supplemental field surveys, such as monitoring spill water or drainage water, is a practical method used to overcome these communication problems.

The second flaw is that it is hard to apply this method to large- or medium-scale irrigation systems. When the number of water users is small, the method is very effective for irrigation distribution. However, the average farmland size per household in the LMB is relatively small compared to Europe or the United States where ordering system is widely used in irrigation schemes. As a consequence, large- to medium-scale irrigation systems are likely to involve an important number of water users, making it difficult to collect the requests from all users. To solve this problem, a strong WUA is essential, as explained in the following example.

– Example

The ordering system applied to an irrigation system is shown in Figure 3.9. In this system, the WUAs are hierarchical. Water users directly belong to the first level WUAs. Several users from the first level are part of the second level WUAs, and some users of the second level constitute the third level WUAs. The fourth level WUA takes decisions for the whole irrigation project and is constituted by leaders of the third level WUAs. There are about 600 first level WUAs, 60 second level WUAs, 14 third level WUA, and one fourth level WUA.

Water users must send their requests for water delivery to the representative of their first level WUA at least three days in advance. The representatives of the first level WUAs sum up the total amount of irrigation water needed at their level and send their requests to a representative of the second level WUA. As shown in the figure, the process continues until the fourth level WUA is reached. Using the total demand of water for the project, the water manager will determine the discharge of intake water and ensure the correct distribution of water to gate operation points.

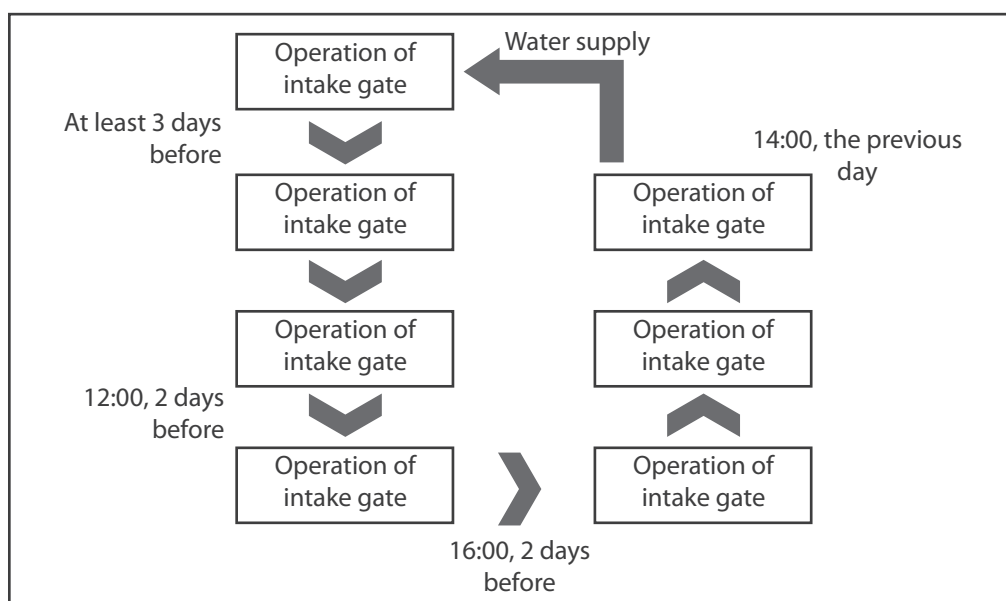

Figure 3.9 Flow chart of water delivery under the ordering system

### Excess water supply

*Some irrigation systems can respond to frequent water shortages by diverting water at levels above demand, during floods for instance. In such cases, excessive water can be stored in paddy fields, canals, or ponds.*

Irrigation water is supplied as required and excess water should not be supplied to improve the irrigation efficiency. Instead excess water can be diverted and stored in regulating reservoirs, irrigation canals and farm plots. The stored water is used for irrigation, reducing the need for water supply in the future.

Regulating reservoirs are desirable for storing excess water supplies. Storing water in canals requires complicated operations of regulators and in order to store water in farm plots, understanding and agreement from farmers is needed. When excess water supply is planned, drainage issues should also be examined.

As diverting excess water from river systems may affect water users situated downstream, it is carried out during flood periods caused by isolated rainfalls. If the excess water is introduced during a short flood period, flood prediction methods and advanced canal operation are needed.

If a remote monitoring system is not installed as part of the project, the water managers predict the occurrence of floods by using the weather forecast and prepare the introduction of floodwater to the regulating reservoirs. When floods are predicted, the managers then determine travel times to each point in the river and irrigation canals. Canal operations are performed in accordance with the water managers' instructions.

### 3.3 Reservoir operations

*When the volume of available water is less than expected in the seasonal irrigation plan, water delivery is restricted by updating the irrigation schedule. Restrictions are implemented before the reservoir storage becomes empty.*

Water supply may be constrained when the amount of water available is lower than the water demand. In gravity irrigation systems (weirs) and systems of pump irrigation from rivers, the water supply is conditioned by river flow rates. If the river flow discharge becomes lower than water demand, the water supply is constrained.

In reservoir irrigation and tidal irrigation systems, a decrease in river flow does not directly result in water scarcity, because the water stored offsets the decrease. However, even if there is enough water stored in the reservoirs, water delivery rates may be restricted to reduce the damage that could be otherwise caused later by a serious water deficit. A greater water shortage over a shorter time will cause more damage than a smaller shortage over a longer time. For example, the damage caused by restricting the water demand by 10% over 2 months are usually lower than those caused by a restriction of demand by 20% over 1 month (although the total deficit of water during the shortage period remains the same in both scenarios). To detect when constraints should be applied on water delivery, rule curves (explained later) are prepared for the reservoir irrigation system.

When water delivery is constrained, efforts to use water more efficiently or to find other water resources are made by water users and operators. Although laborious, frequent changes of water supply are occasionally implemented to reduce water losses (this method was presented in Figure 3.2 as ‘water supply with excellent irrigation scheduling’). In addition, rotational water delivery or other temporary water management methods may be implemented for efficient water use. If economically possible, pumping irrigation or reusing water should be carried out temporarily. These countermeasures need to be discussed among representatives and relayed to all the water users.

Deficit irrigation, by which insufficient irrigation water is applied to fields, is one method of reducing water supply. In the case of rice production, it has only been attempted in China and is not widely used yet.

#### – Rule curves

The rule curves of an irrigation system with a single reservoir are shown as an example in Figure 3.10. Three different targets are set for the storage volume; they are shown as lines in the figure and used as references for restriction. Irrigation water demand is high during summer (especially in May and August) in this irrigation project, but it drops

during winter. Because the reservoir capacity in this project is small compared with those in other service areas, water shortages occur often, hence the need to constrain water use in order to avoid serious damage.

If the storage in the reservoir drops beneath the first rule line, restrictions on water use starts. If the storage drops further, beneath the second or third rule lines, heavier restrictions are imposed. The level of restrictions is decided during meetings attended by representatives of water users and by project staff.

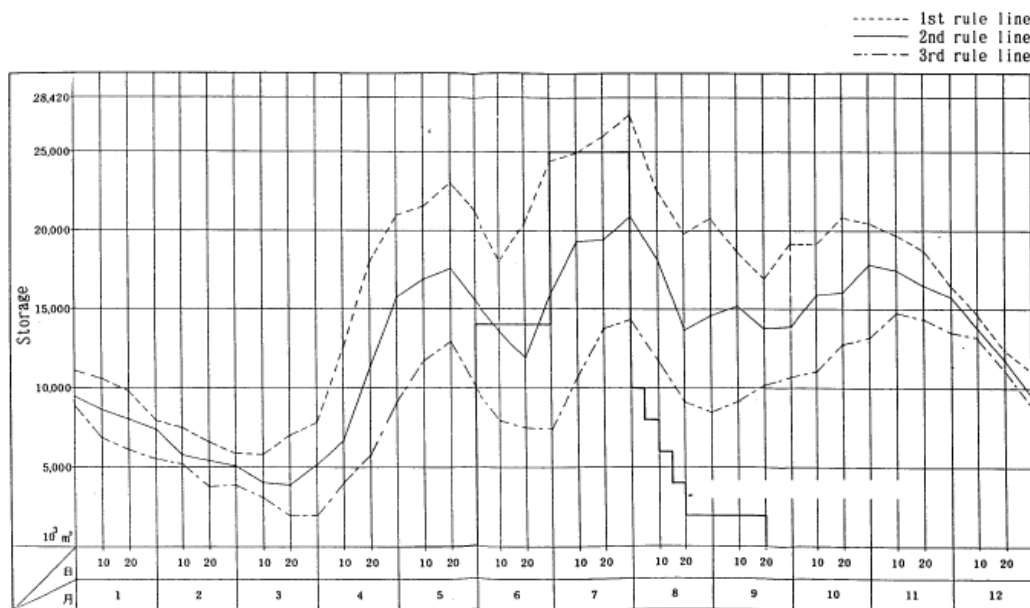

Figure 3.10 Constraint curves for reservoir operations

### 3.4 Canal operations

#### Outline of canal operations

*Canal operations aim to deliver sufficient water to farm plots and at the same time reduce water spillage from main or secondary canals. For this purpose, a canal operation plan should be established.*

Canal operations involve actions that operate gates or valves at canal structures such as intakes, turnouts, or cross-regulators. Canal operations aim to deliver water as determined in the irrigation schedule. Both an excess of water supply and a delivery deficit should be avoided. An excess of water supply may cause an overflow at spill points and farm plots, while a water

deficit results in low reliability. A canal operation plan decides when, where, and how the gates or valves are operated.

Different actions to operate turnouts (see below), cross-regulators (see page 46) and regulators in low-lying areas (see page 48), and the importance of effective communication between operators (see page 48) are discussed in this section.

### **Operation of turnouts**

*Turnouts should be operated to divert water to branch canals for which water flow has been defined by irrigation scheduling. In gravity irrigation systems it is advisable to operate turnouts to control flow rates. The type of operation depends on the measurement system. Unless flow rates are measured, a control of the water level is applied.*

Turnouts are used to distribute irrigation water from a canal to a smaller canal or a farm plot. They are operated to divert water to branch canals for which water flow has been defined by irrigation scheduling. Water is diverted through gates or valves, where water flow is usually affected by water levels in the upper system, that is, the water levels of a canal diverting water. Automatic gates, which can divert water flow at constant rates, have been introduced in some irrigation systems (see section 5.6), but they are not yet prevalent. Water level fluctuations in canals are major obstacles to the appropriate operation of canals.

The causes of water level fluctuation and their possible countermeasures are outlined in this subsection and are followed by a detailed explanation of countermeasures that can be implemented by gate operation (for instance, turnout operation from upstream to downstream in sequence or frequent turnout operation).

There are two ways of controlling a water flow. One is to control the water flow rate; the other is to control the flow level. Both ways have advantages and disadvantages, and will be discussed later. A simple method used to estimate water travel time is also introduced at the end of this subsection for reference (this information can help operate turnouts from upstream to downstream in sequence)(see page 45).

#### *Water level fluctuation and its countermeasures*

With a sluice gate, the flow rate is prescribed by gate opening, and the level of water upstream and downstream. Even if the gate opening is kept constant, the flow rate of diverted water is affected by changes of water levels in the canal upstream. Such fluctuations disturb the constant diversion of water to the branch canal (Figure 3.11).

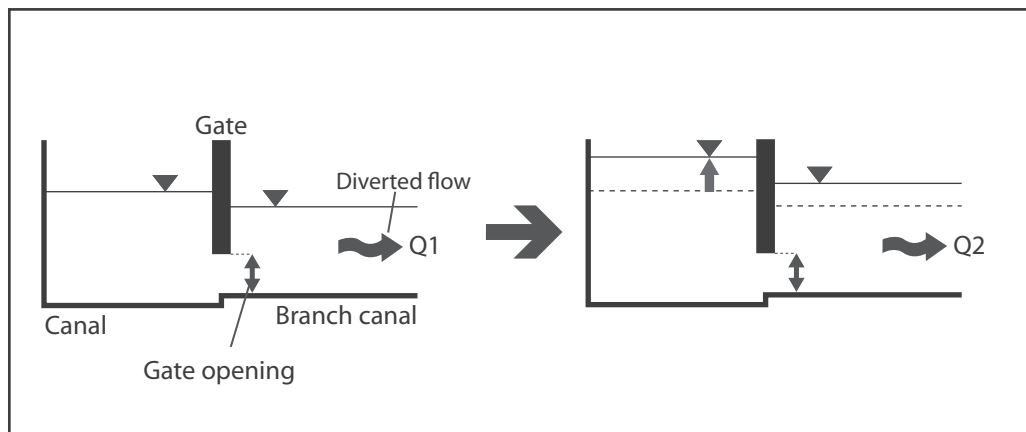

Figure 3.11 Changes in flow rates of diverted water with fluctuations in water level

If the water level of the canal upstream is raised, the flow rate of the diverted water is increased from Q1 to Q2 depending on the head difference for the same gate opening. To keep the diverted flow constant, the gate has to be adjusted when the water level in the canal changes.

These fluctuations in water level are caused by uncontrolled flow (see 5.3), operations of direct turnouts (see 5.3), shorter or longer travel time, and unexpected canal operations (see Figure 3.12). Several measures can be taken to keep the rate of a diverted flow constant: (i) operations from upstream to downstream in sequence, (ii) frequent operation, (iii) communication among operators (see page 48), (iv) better organisation (see section 6.3) and (v) improvement of physical structures (installation of regulating reservoirs (see section 5.1), cross regulators (see section 5.2), automatic gates (see section 5.6) and improvement of canal systems (see section 5.3)).

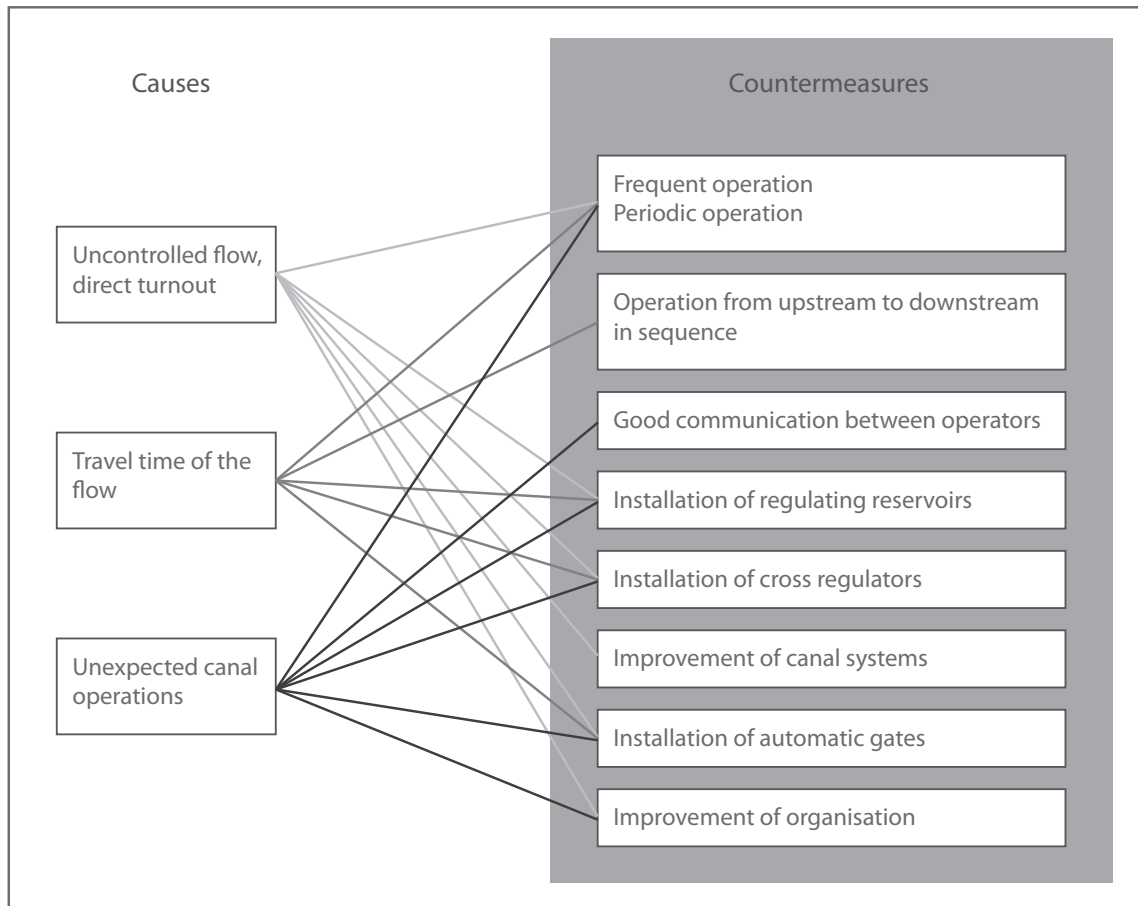

Figure 3.12 Causes of water level fluctuations and countermeasures

### *Upstream operation of turnouts*

Excluding low-lying irrigation systems, the effects of gate operations on downstream flow in an open channel are affected by the upstream flow. Thus it is preferable to operate turnouts upstream then downstream in sequence. The first turnout of a canal system should not be operated until the flow caused by the change of intake has also changed. It is only when the flow has changed at the first turnouts that the gates or valves can be operated and that the affected water can go down the irrigation canal. The other turnouts are operated in order from upstream to downstream in sequence (Figure 3.13). Travel times at each turnout can be determined by calculation or from experience (see 'Estimation of travel time' in this section).

Upstream operation of turnouts reduces the frequency of turnout operations. Each turnout is operated only once when the water distribution changes. This method, however, is not applicable to certain systems in which frequent operations are needed to stabilise the water diversion. Unsuitable systems include those:

- with a main canal too long, where flow requires more than half a day to reach the end of the system;
- with large uncontrolled flows and with water diversion via direct turnouts; and
- where flow is measured by water level.

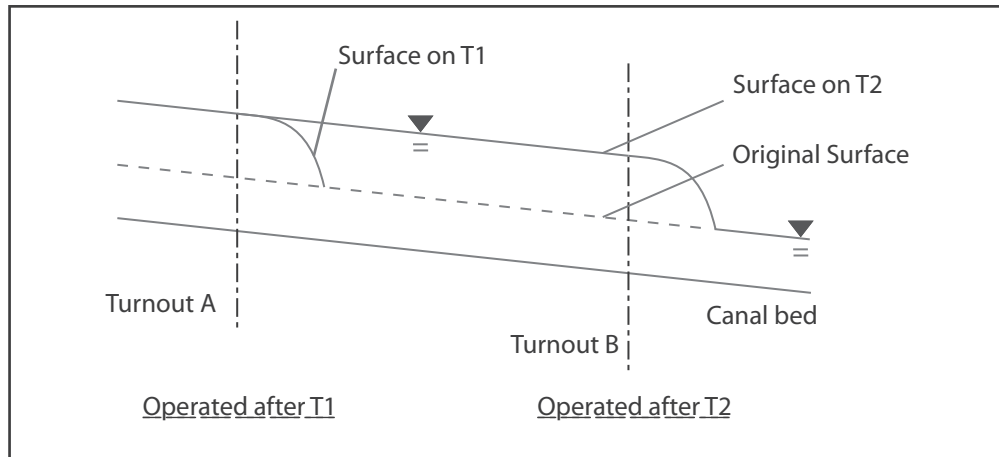

Figure 3.13 Operation from upstream to downstream in sequence

*Turnout A* is operated after the change of intake flow arrives at T1. *Turnout B* is operated after water affected by the intake change and the operation of turnout A arrives at T2.

### *Frequent turnout operation*

Unless turnouts are operated from upstream to downstream in sequence, water level fluctuation may occur at each turnout. In addition, if there is an unexpected inflow or outflow, which is possible with uncontrolled flows, water level fluctuation may also occur and change the flow of diverted water.

In such an irrigation canal system, a gate operator starts by changing the opening of gates one by one to maintain the planned water flow. The operator then goes back to the first turnout after having operated all the turnouts he or she had in charge. The operator may find that water level fluctuations have changed the diverted flow. He or she must change the gate or valve opening repeatedly at all turnouts until the water flow prescribed in the irrigation schedule is achieved. It may take several turnout operations for one change of water distribution (Figure 3.14). Although laborious for gate operators, it is necessary to achieve high irrigation efficiency.



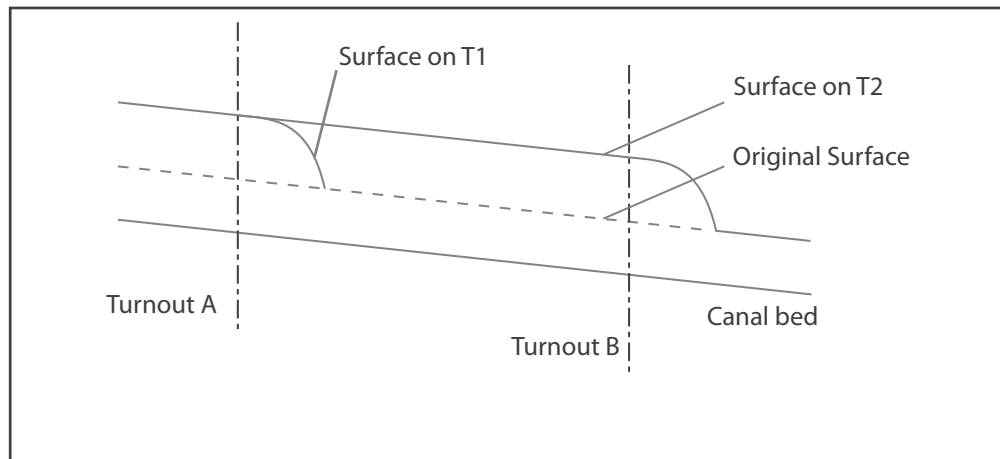

Figure 3.14 Frequent gate operation

*If turnout B is operated before the flow change arrives, i.e. at T1, turnout B will need to be changed again after T2.*

Occasionally, it is difficult to stabilise water level fluctuations, so turnouts will need to be operated many times to achieve an appropriate water distribution. In some irrigation systems, the daily operations of turnouts are scheduled in order to save labour and are done at the same time every day (for instance, three times a day at 08:00, 12:00, and 16:00). This kind of periodic operations can be used in an irrigation system with long main canals, where it takes a long time for water to flow from the intakes to the end of the canals.

Frequent turnout operations are also used for water level measurement and control systems (some examples are mentioned below), even if fluctuations of water level are not expected.

#### *Flow rate and water level controls*

Two methods are used to control water, one is flow rate control and the other is water level control. The choice of a method depends on the measurement involved. Namely, if flow rates are measured, flow rate controls can be done, but if only the water level can be measured, it will still require manipulations. Flow rate control is easier than water level control for appropriate water distribution in a gravity irrigation system.

Figure 3.15 shows some differences between the two methods of measurement. In this example, an irrigation system with three secondary canals is assumed. If the flow rates of water diverted to each secondary canals is respectively 1.0, 0.5, and 1.5 m<sup>3</sup>/s, then the water flow rate at the intake point can be simply estimated at 3.0 m<sup>3</sup>/s (the sum of water flow rates in secondary canals). Unlike the flow rate, the water level cannot be estimated directly and requires calculations.

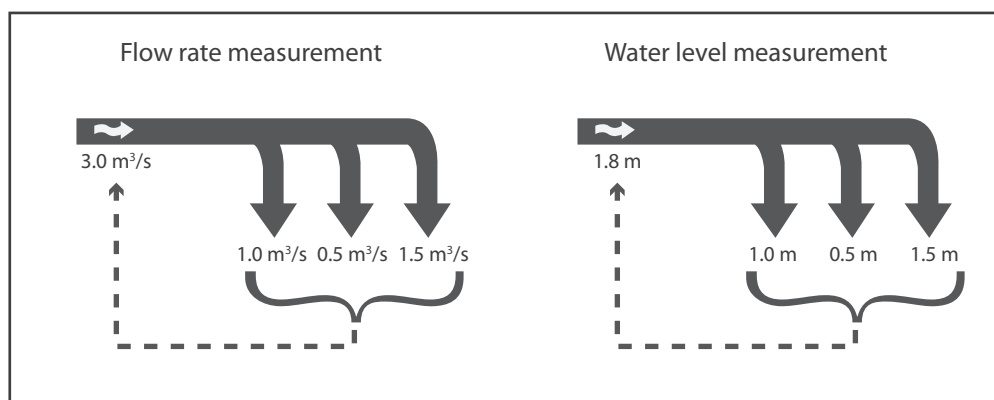

Figure 3.15 Differences between flow rate and water level measurements

A gate operator may know some combinations of water levels (for instance, 1.8, 1.0, 0.5, and 1.5 m or 1.2, 0.5, 0.3, and 1.0 m), but gaining such skills requires experience. Thanks to these skilled operators, many irrigation schemes employ the water level control and measurement system and it works well. Even in such an irrigation scheme, water distribution lacks flexibility and only a limited combinations of flows can be used. If new combinations become necessary to divert water, an operator must seek new ones by trial and error. Although this system has difficulties in terms of efficient water management, it is widely employed because the installation of the equipment is easy. Only water level gauges are needed, and flow rate measurements are not required.

Flow rate measurement is costly, because it demands measurement apparatus such as flow meters or formulae for converting water levels to flow rates (rating curves). However, once such a flow rate measurement system is set up, it makes canal operations manageable. Irrigation schemes that use the water level control and measurement system should seriously consider shifting to the flow rate control and measurement system.

#### *Types of turnout operations*

Turnout operations are grouped into six types of water control methods and operations to avoid water level fluctuations (Table 3.3). In the table, the types are arranged in order of operational difficulty. Improvement of turnout operations is normally conducted from type F to type A.

Table 3.3 Types of turnout operations

	Control/Measurements	Operation type	Difficulty
A	Flow rate control (measurement) at main turnouts	From upstream to downstream in sequence	Difficult
B		Several times a day (long canal system)	
C	Flow rate control (measurement) at key points Water level control (measurement) at main turnouts	Several trials, or experience	↑
D	Water level control (measurement) at main turnouts	Several trials, or experience	
E		Rotation between turnouts	Easy
F		Proportional distribution without reflection of changing demand	

#### Reference: Estimation of travel time

If turnouts are operated from upstream to downstream in sequence, it is desirable to know when each turnout should be operated in order to save on labour. Each turnout is operated after the change in water flow arrives. The estimation of travel times is useful for turnout operations from upstream to downstream in sequence and is also used to calculate the storage volume of a regulating reservoir (see section 5.1).

Accumulating knowledge through the practice of daily water management can help determine travel times, but it requires much time. Some methods have been proposed to estimate travel time. An unsteady flow model is introduced here to estimate travel time accurately, but the information needed for this calculation takes much effort. Since accuracy is not essential when it comes to turnout operations, a simple method that assumes uniform flow is recommended here (Figure 3.16). The two-thirds travel time ( $T_{2/3}$ , the time during which two third of the flow rate change has arrived) is estimated in a simple equation (Yoshino *et al.*). If Manning's roughness coefficient is used, the equation is as follows:

$$T_{2/3} = L(A_2 - A_1)/(Q_2 - Q_1)$$

$$Q_1 = \frac{1}{n} I^{1/2} S_1^{2/3} A_1^{5/3}$$

$$Q_2 = \frac{1}{n} I^{1/2} S_2^{2/3} A_2^{5/3}$$

Where:

n: Manning's roughness coefficient

L: Length of canal

Q1,Q2: Flow rate before and after the change of flow, respectively

A1,A2: Cross-section before and after the change of flow, respectively

S1,S2, Hydraulic mean depth before and after the change of flow, respectively

I: Slope of canal bed

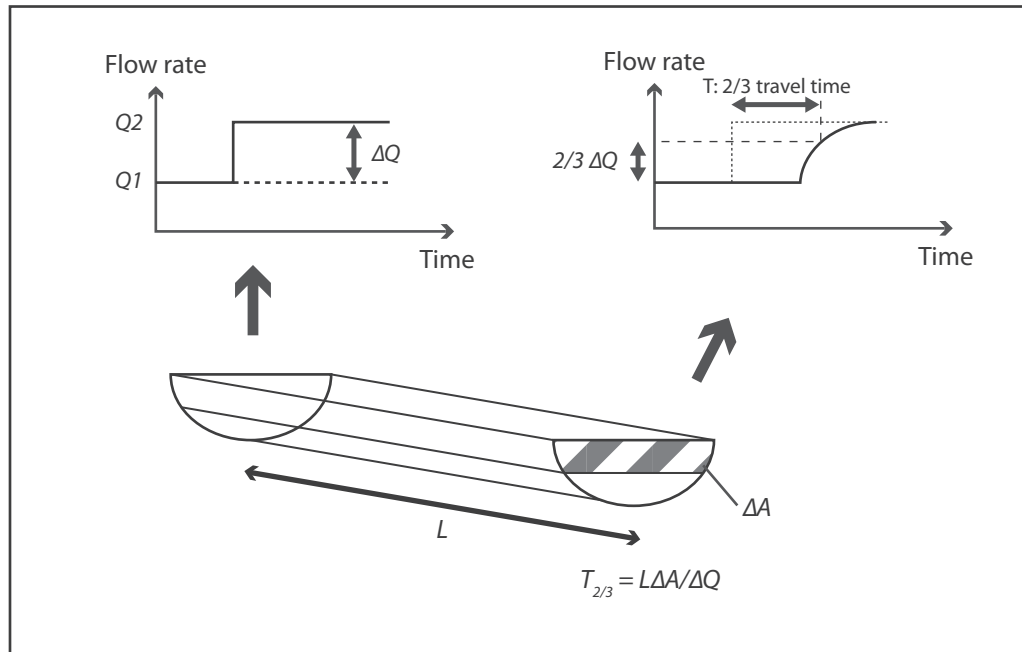

Figure 3.16 Estimation of travel time

### Operation of cross-regulators

*There are two types of cross-regulator operations, upstream control and downstream control. The choice of one or the other depends on physical and social conditions.*

#### *Upstream and downstream control*

There are generally two types of cross-regulators (Figure 3.17). One is controlled to keep the upstream water level constant, while the other keeps the downstream water level constant.

An upstream control regulator maintains the level of diverted water to a branch canal. It can prevent water level fluctuations and makes turnout operations easier. Although an upstream control regulator is useful for turnout operations, canal operations should strictly be implemented as planned for the following reasons. The presence of cross-regulators enables upstream turnouts to divert the design water flow at any time. If upstream turnouts have an advantage when diverting water, it is a disadvantage for the irrigation system as a whole. If too much water is diverted at the upstream turnouts, then the downstream turnouts suffer from water deficit. When cross-regulators controlling upstream water level are installed, upstream turnouts need to be strictly operated as planned to achieve appropriate water delivery.

On the other hand, a downstream regulator keeps the downstream water flow constant. This type of regulator is suitable in irrigation systems with a long main canal because it guarantees water flows in downstream canals, which usually are handicapped when it comes to receiving sufficient water. Some drawbacks of downstream regulators are the need for a bigger canal capacity or shorter intervals between installed regulators.

Either types of cross-regulators can be used to reduce the travel time of water in a canal system, but they have to be set up appropriately.

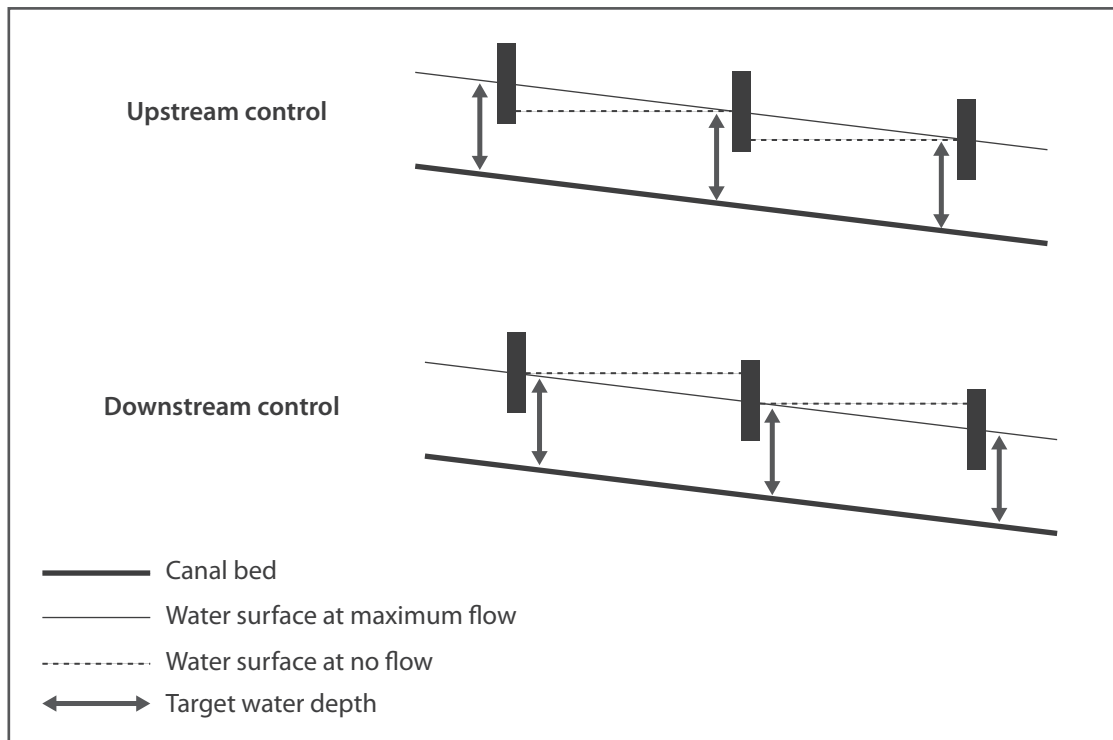

Figure 3.17 Features of upstream and downstream controls by cross-regulators

#### *Use of cross-regulators as regulating reservoirs*

Cross-regulators can be used as regulating reservoirs, but only in exceptional cases. They involve complicated operations.

A cross-regulator can temporarily store and prevent water from being released through wasteways or spill points when water demand stops suddenly (Figure 3.18). A cross-regulator is fully or partly opened under normal operation. When rain comes and water demand falls, the cross-regulator is closed to adjust flows, and thus decrease the water supply downstream. Excess water is stored upstream of the cross-regulator until the water with decreased flow at the intake point reaches this cross-regulator point.

Conversely, when downstream water demand abruptly increases, water stored by the cross-regulator is released.

Remote monitoring and remote control systems are needed to implement these delicate operations (see section 5.5).

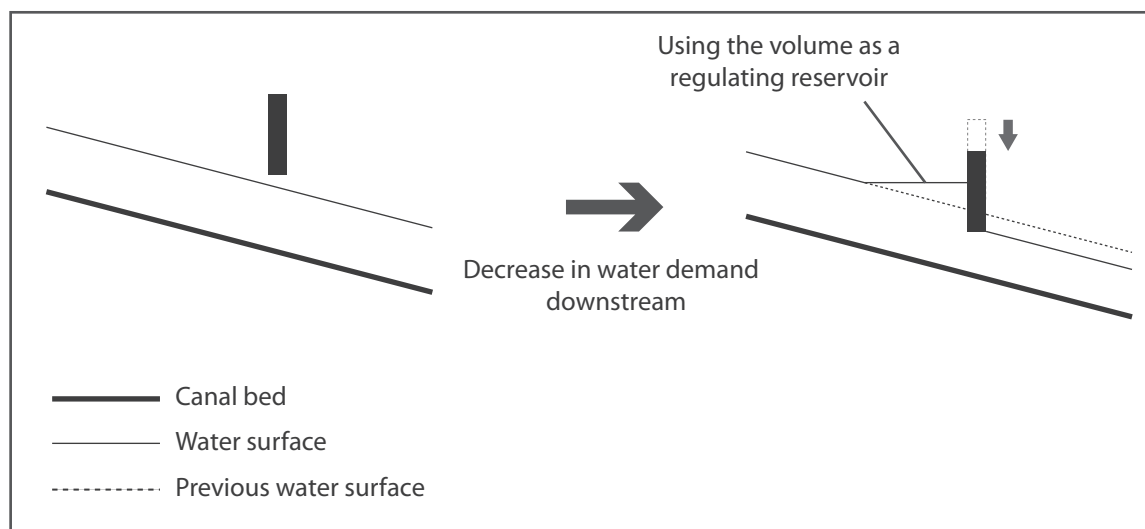

Figure 3.18 Use of a cross-regulator as a regulating reservoir

### Operation of regulators in low-lying areas

*In low-lying areas, regulator operations are implemented to maintain the target water level in consideration of the mutual effects of gate operations.*

In low-lying areas, an objective of canal operations is to maintain water levels in the whole irrigation system as high as possible within a target range. Changes in water levels in an irrigation canal are usually transmitted from upstream to downstream. In low-lying irrigation systems, however, water flow is affected by downstream water levels. This feature makes canal operations complicated. Sometimes many gates (turnouts or cross-regulators) can have a big influence on each other. Operating canals in low-lying areas is complex and require a high level of skills based mainly on practical field experience (although inundation analysis by computer model simulations can ease the process)(see section 5.8).

### Communication between operators

*Operators should communicate with each other to reduce spill water volumes, unexpected fluctuations, and water deficits in the main and secondary canals.*

If an irrigation system is small, one single operator can operate all the turnouts and regulators. Usually, however, two or more operators control the irrigation water in large- or medium-scale irrigation systems. This implies that the responsibility of canal operations is shared among operators. In this case, communication between operators is very important to prevent water level fluctuations, water spills from canal systems, and water deficits in irrigation systems.

Water level fluctuations influence the flow of water diverted to branch canals (see page 39). Turnout and regulator operations cause variations of water levels in open channels situated downstream. If one operator changes gates or valves against an irrigation schedule, he or she must inform the other operators and instruct them to change the gate or valve opening to maintain the diversion as planned.

A canal operation plan designed to prevent water spills and water deficits is given in the irrigation schedule. Even if the plan is followed, water spills or water deficits can still occur due to unexpected water flows into or from canals. Canal operations then need to be adjusted to meet the actual situation. When water spills or water deficits occur, the relevant operators should be informed.

Furthermore, from time to time, the irrigation schedule may not be followed. Obviously canal operations have to follow the irrigation schedule in principle, but actual water demands sometimes differ from those originally planned. When water demand is lower than the estimated volume in part of an irrigation system, an operator in charge can reduce water diversion to related tertiary or secondary canals in an effort to save water. This operation can be encouraged to increase the irrigation efficiency, but operators in the upstream section should be informed or it will not help saving water. Operations such as withdrawal of intake points, release from reservoirs, or diversion of upstream turnouts will need to be changed so as to meet downstream turnout operations if water is to be saved (Figure 3.19).

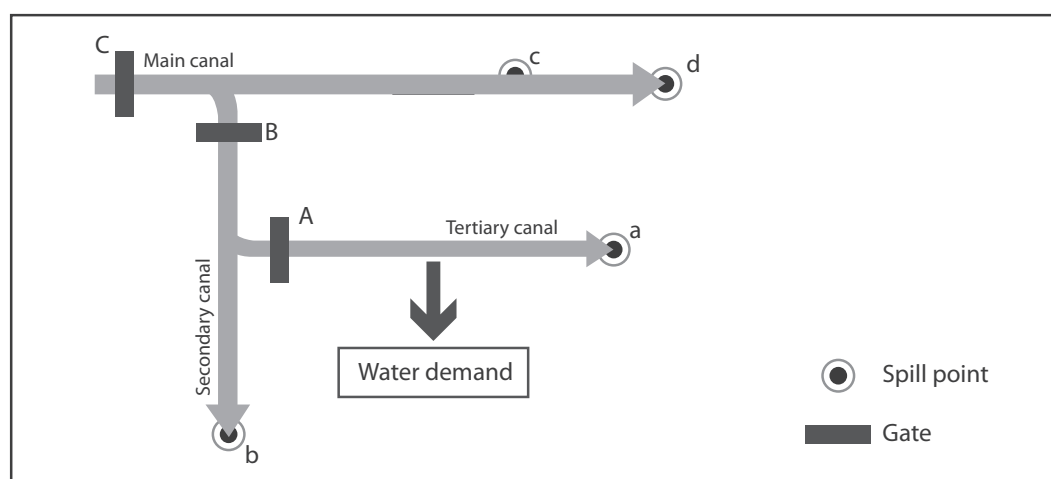

Figure 3.19 Communication between operators in order to save water

*A lower water demand has been predicted and in this case, the operator or leader of the WUA will reduce water supply to the*

tertiary canal by operating gate [A]. This is a desirable operation and it can prevent spill water at point [a]. However, if gate [B] is not operated, operation of gate [A] will only result in a greater spill water at point [b] and water will be wasted. When one gate ([A] in this example) is operated, the appropriate gate operators (at [C] and [B]) should therefore be informed so as to save water.

In general, there is a hierarchical system of canal operations if there are several operators. An irrigation project may usually design a member of the staff as water master. In a large-scale irrigation system, the operation of the main canal may then be divided into several operators or operators' groups (Figure 3.20). Meanwhile, secondary or tertiary canals may be operated by others.

Usually, communication between upper-level and lower-level operators is well established (e.g., A in Figure 3.20). On the other hand, communication between same-level operators is sometimes poor (e.g., B in Figure 3.20). Information may be transmitted between same-level operators through the upper-level operator, but this process may delay the transmission. To prevent water level fluctuations, the operations of one single operator need to be passed to the other operators on the same level. A routine method of communication between operators at the same level should be established.

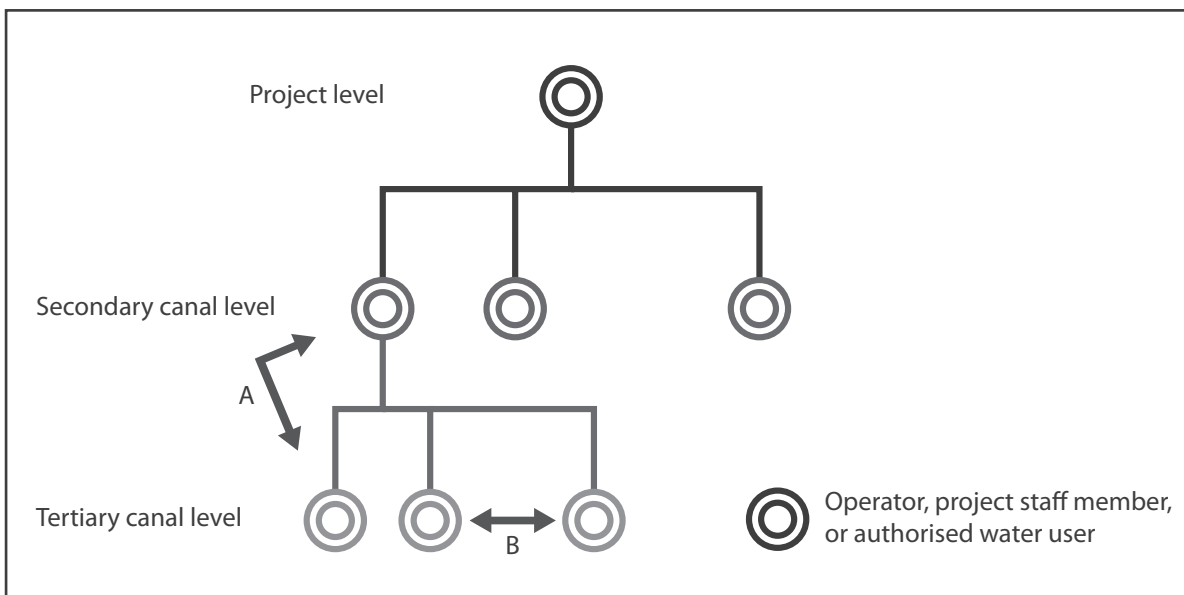

Figure 3.20 Communication between operators at different levels



## 4. Water management of tertiary canals

### **Issues of water management in tertiary canals and equity among water users**

Irrigation canals that divert water to farm plots are referred to as various names, including delivery canal, ditch canal, farm canal, and tertiary canal. The term tertiary canal is the name chosen for this guidance.

Water distribution and operations in tertiary canals are generally the same as those in main and secondary canals. However, some turnout operations are different between tertiary and other canals. In the main and secondary canals, turnouts are operated by employed staff or authorised water users in general while in tertiary canals they are usually operated by water users (farmers). This is a major feature of tertiary canal operations. It is relatively easy for project managers to control turnout operations in the main and secondary canals by giving instructions to the operators. Yet it is difficult for most ordinary water users to operate turnouts appropriately. To save on labour, some farmers do not want to operate turnouts frequently; others may not follow water delivery rules, such as those for rotational irrigation. When inadequate conditions in farm plots may cause an inefficient use of water, even if turnouts are appropriately operated, land consolidation should be implemented.

If water management in a tertiary canal is not implemented appropriately and diversion to farm plots is not controlled, farm plots upstream usually receive more water than those downstream (head and tail effect)(Figure 4.1). If the water supplied to farm plots at the tail of the tertiary canal is equal to the water requirement, then the water supplied to the whole tertiary canal will be greater than needed (Case A in Figure 4.1 on page 52). In contrast, if the water supplied to the whole tertiary canal is equal to the total water requirement of all the farm plots, then the farm plots downstream may receive less water than required (Case B).

Excess water diverted to tertiary canals drains from the farm plots. Drainage of water from farm plots upstream is a factor of water loss in an irrigation system. As some of the water drained comes from rainfalls, it becomes hard to identify water losses in either drained water or excessive diversion to farm plots. For this reason, it is important, but also difficult, to reduce water losses caused by excess water diversion from tertiary canals to farm plots (Figure 4.2 on page 53).

On the other hand, if excess water is not diverted to the tertiary canals, it will cause water deficits in the farm plots downstream while water will be provided in excess to the farm plots upstream. This creates inequity among water users in the tertiary canal and may make some water users less diligent in their water management (resulting in a degradation of the water allocation and water distribution). Therefore, maintaining equity helps managing irrigation correctly. An irrigation system has different levels at which equity should apply, but maintaining

equity among tertiary canals is one of the most important factors for improving irrigation efficiency.

Several measures can be taken to prevent inequity at the tertiary canal level. These measures can be implemented at different levels: (i) the establishment of WUAs (see section 4.2), (ii) prohibition of turnout operations by water users (see section 4.2), (iii) rotated water delivery among tertiary canals (see section 4.3), and (iv) enhancement of plot-to-plot irrigation practices (see section 4.4).

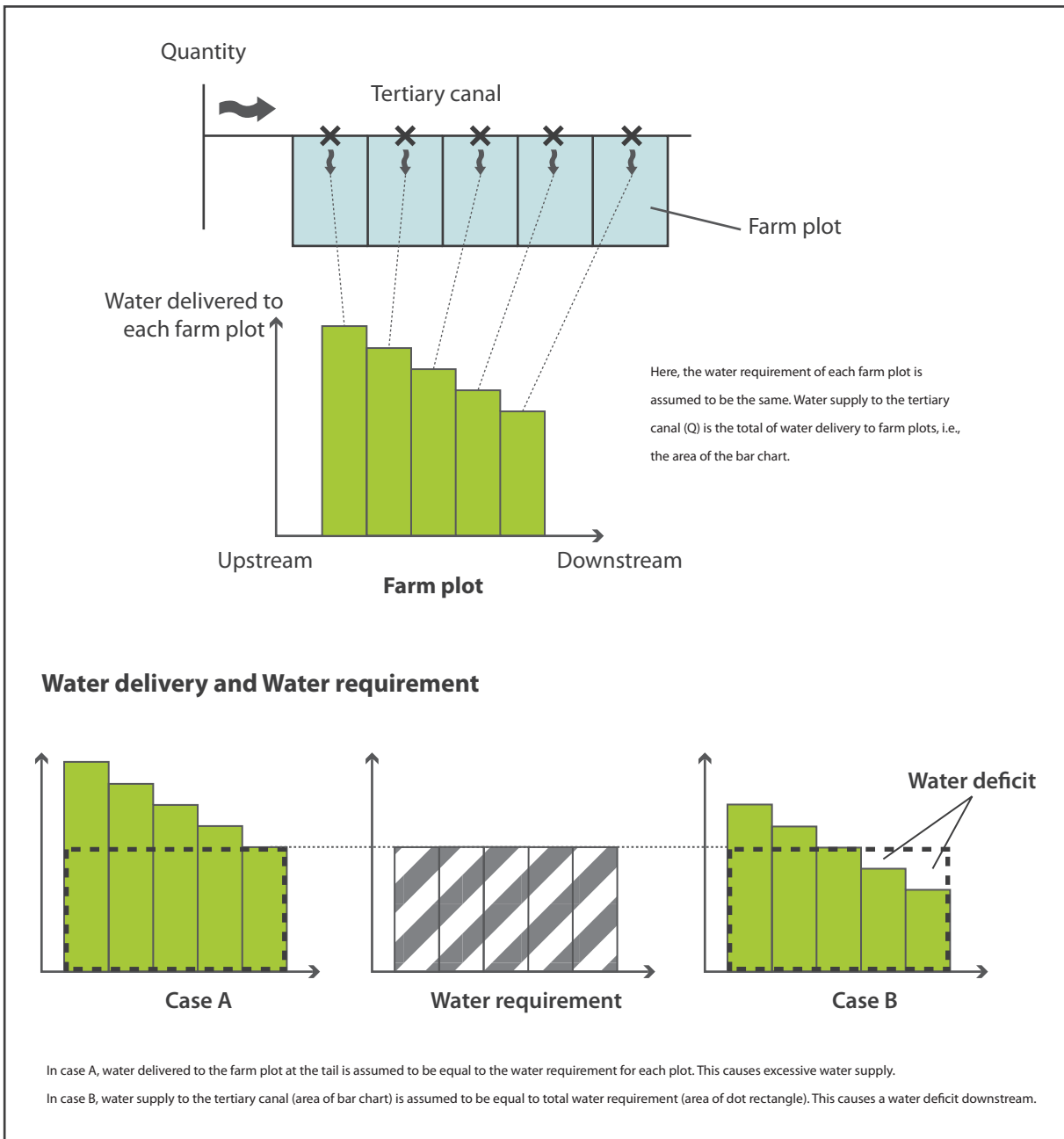

Figure 4.1 Water distribution and water loss in a tertiary canal



Figure 4.2 Excessive water in a farm plot as a result of excessive water supply

#### 4.1 Establishment of WUAs

*WUAs (water users' associations) play important roles in reducing excess water intake at the tertiary canal level. In tertiary canals, water users upstream are likely to take more water than they need. This results in an excess of water delivery compared to the actual demand at turnout points. Mutual monitoring and setting of rules among water users in tertiary canals—measures that can be initiated by the WUA—are useful to prevent such behaviours.*

The main problem in irrigation management of tertiary canals lies with the operators of turnouts. Unlike those of main or secondary canals, these operators are usually individual water users (farmers). Water users sometimes operate turnouts for the benefit of their own farm plots and do not respect rules or other regulations; this results in an unfair delivery of water for some water users. Organising water users and performing appropriate turnout operations are important to prevent the diversion of excess water flows into the tertiary canal. In this regard, WUAs play a significant role.

There are different types of WUAs, depending on the scale. It can be a WUA at irrigation project level, secondary canal level, or tertiary canal level. WUAs for tertiary canals are effective in controlling the water at tertiary canal levels, although other WUAs can also affect water control at this level.

Rules are established by the WUA to perform irrigation schedules and turnout operations. To encourage users to follow the rules, effective communicators and strong leaders are needed. WUA meetings are effective tools to create a fair distribution of water.

## 4.2 Prohibition of turnout operation by water users

If only one authorised water manager operates turnouts from tertiary canals to individual farm plots, water losses are reduced in comparison to those that would be generated if individual users were operating the turnouts diverting water to their plots. However, since this style of operation deprives water users of the opportunity to manage their own water, it should only be used during periods of severe water shortage.

Irrigation water is usually diverted from tertiary canals into farm plots by water users (farmers). This is the main cause of confusion in water distribution. One effective way of maintaining a correct water delivery is to prohibit water users from operating turnouts connected to their own farm plots: only an authorised water manager is allowed to deliver water to farm plots.

This method of canal operation can reduce an excessive diversion of water, but it requires additional labour input and it makes it hard for farmers to perform manuring practices, such as fertilising, on their own schedules. Some irrigation systems introduce this operation only when the deficit of water is critical. Establishment of a WUA for tertiary canals is essential for this practice.

Figure 4.3 shows an example of the impact of prohibiting the individual operation of turnouts on water supply. In this case, the annual water supply of one tertiary area of an irrigation scheme in China is shown. Water supply to the tertiary canals was decreased by about 40% after introducing the system (2003–2005).

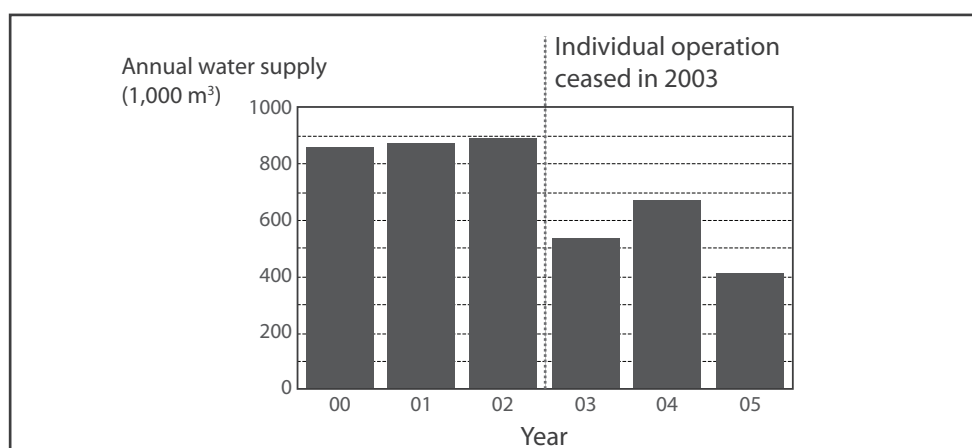

Figure 4.3 Impact of prohibiting individual turnout operation on water supply (Ren *et al.* 2005)

Furthermore, the prohibition of turnout operation by each water user results in a more efficient water delivery. If water is delivered to farm plots in turn, a high irrigation efficiency is achieved (Figure 4.4). With this method, the first temporary weir is made at point (a) in the tertiary canal, diverting all water from the canal to farm plot (A). When the irrigation water supply reaches a benchmark, the temporary weir at point (a) is removed and the water diversion

is stopped to let water flow to point (b). Next, a temporary weir is made at point (b) and the irrigation water is introduced to farm plot (B). This process continues from the upstream to downstream sections one by one.

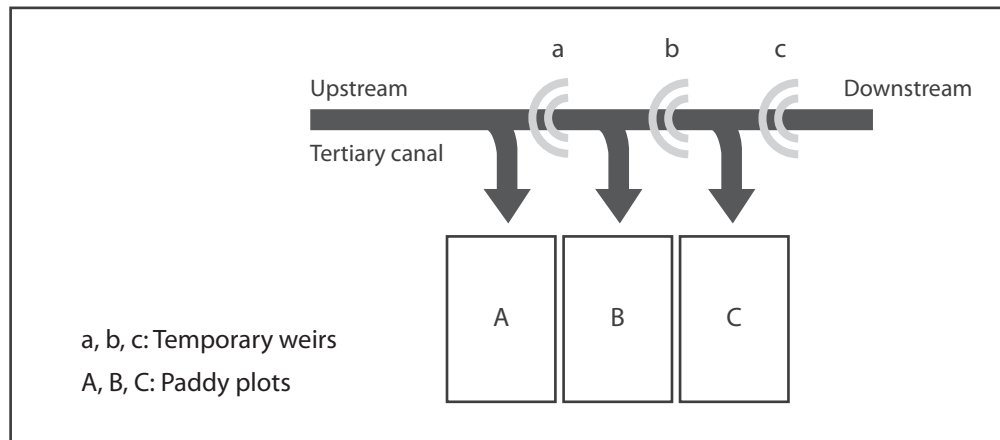

Figure 4.4 Illustration of a step-by-step water delivery system along a tertiary canal

### 4.3 Intermittent water delivery to tertiary canals

*Inequity of water delivery becomes a more serious issue when the water supply is small. Use of an intermittent (on-off) water supply is one way to reduce inequity. Also, when the WUA does not function properly, rotation among tertiary canals is an alternative for improving equity.*

It is prudent to share water equally among water users in a tertiary canal when the flow rate in this canal is low. However, if the relations between water users in the WUA are not strong, upstream water users will divert water to their farm plots just as they would normally when the water supply to the tertiary canal is good. This leads to severe water deficits downstream. Inequity of water delivery tends to become a more serious issue when water flow rates are low.

One method of keeping equity at the tertiary canal level is to divert water at the maximum flow rate of the tertiary canal but for a specified period of time. It can at the same time restrict excess diversion to upstream farm plots. This method is called intermittent water delivery (see page 28). With this method, the volume of water supplied to the tertiary canal is controlled not by flow rate but by duration of flow.

Because the capacity of main or secondary canals is usually limited, a rotated water supply is often adopted among tertiary canals when intermittent water delivery to tertiary canals is done. Rotated irrigation supply among tertiary canals is effective to reduce water loss and inequity of supply in the tertiary canals, because it prevents excess diversion by upstream water users.

## 4.4 Enhancement of plot-to-plot irrigation practices

*Occasionally there are conflicts between water users with plot-to-plot irrigation. Mediation by the water manager or WUA leader can resolve these conflicts. Identification and recognition of the irrigation flow route is a useful exercise for water users to set up a mutually cooperative framework.*

Water delivery to farm plots is grouped into plot-to-plot irrigation and individual plot irrigation. In the latter system, each farm plot receives water from canals through its own turnouts. In the LMB, however, plot-to-plot irrigation is dominant, so the irrigation water passes through several farm plots before reaching the distant farm plots.

The features of plot-to-plot irrigation compared with individual plot irrigation are explained in Figure 4.5 and they can be summed up as follows:

- Several water delivery routes lead to a farm plot; water users may not always be aware of all of the possible routes.
- It is difficult to know whether or not there is enough water along water delivery routes.
- Water delivery can be affected by manuring practices, such as fertiliser application, along the water delivery route.

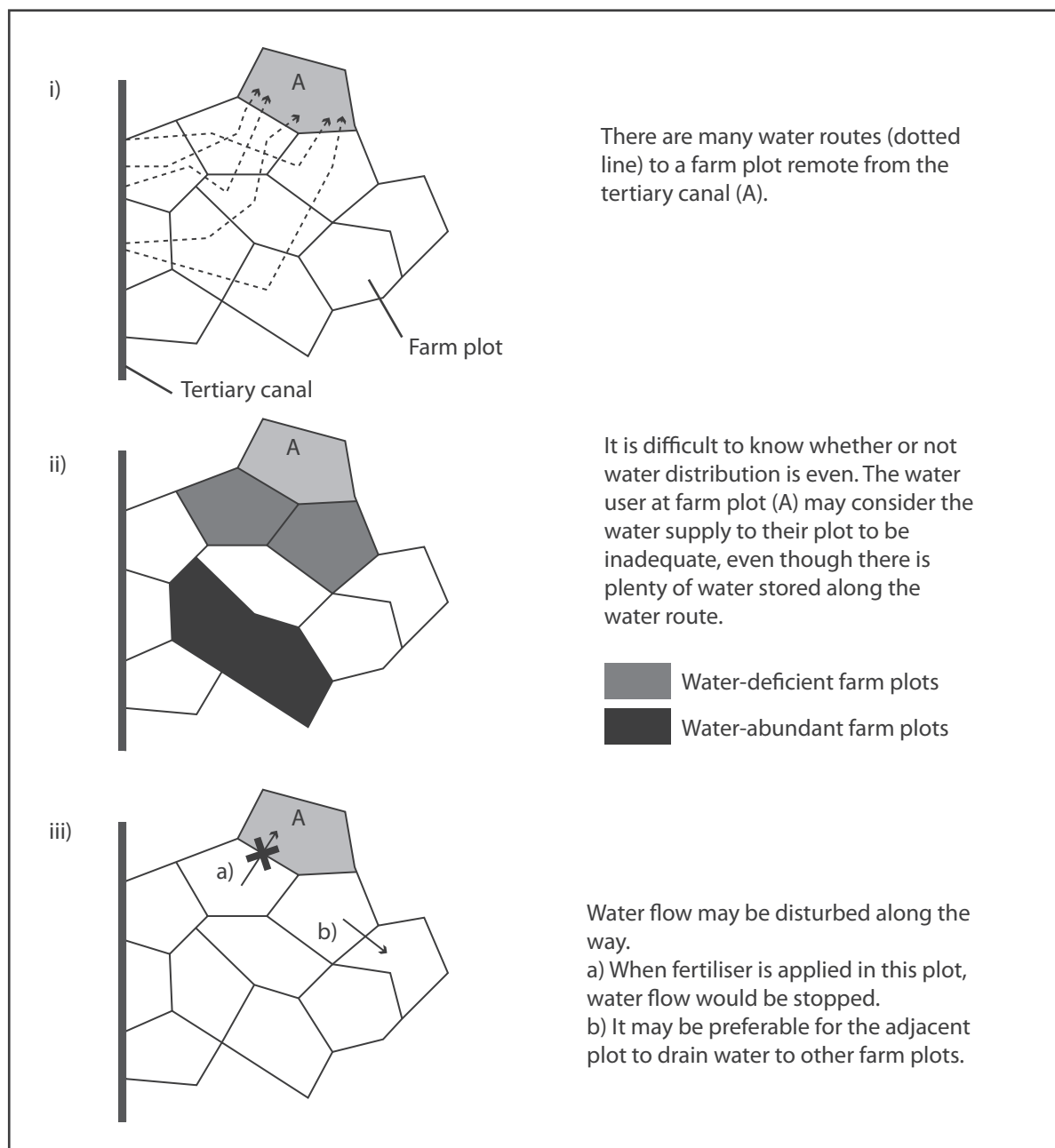

Figure 4.5 Schematic explanation of, and issues related to, plot-to-plot irrigation

The features of plot-to-plot irrigation can create problems between farmers in regard to water distribution, which will in turn cause an uneven water distribution and low irrigation efficiencies.

One solution to counter these problems is to construct or expand tertiary canals (see section 6.4), and a second one is to set up an organisation in charge of settling the conflicts. Such conflicts are usually confined to the water users involved. However, issues of water distribution should be considered as common issues for all water users in a same canal irrigation area, and these issues should be discussed and solved by the WUA.

First, water users should be able to understand water delivery routes, and know the reasons behind water deficits. One method of doing this (water-use mapping) is discussed below. Next, a tertiary canal operator or WUA leader should tell the water users involved whether or not the water supply to the tertiary canal is adequate. If the supply to the canal is adequate but water deficits still occur in some farm plots, then the farm plots along the water delivery route should be inspected. If a farm plot is stopping water flow or draining it in a different direction, then the WUA should persuade the water user to release the water. Rules for manuring practices may be established within the tertiary system and should facilitate such negotiations.

*Water-use mapping (water flowcharting by farmers)*

Creation of a water flowchart showing water flow for each farmer's field (based on paddy fields maps) is one method of establishing good relations among water users. A water flowchart is a map on which the water route is drawn in the plot-to-plot irrigation system. First, a map of the target area is prepared. Next, water users are invited to draw the flowchart. All the farmers having plots involved are identified. They are then interviewed to determine from which farm plots they receive water and to which farm plots they drain water and the water flowchart is completed (Figure 4.6).

This work reveals the relations between farm plots. The flow chart is a useful tool for resolving conflicts among water users. On top of that, creating a chart promotes discussions and creates channels of communication for carrying out collective work.





Figure 4.6 Implementation of water-use mapping (Tomosho *et al.* 2006, 2007)

*Left:* Map of the target area; *Right:* water flowchart; *Center:* map-drawing exercise by farmers.



## 5. Improvement of physical structures

### 5.1 Installation of regulating reservoirs

*Regulating reservoirs in a canal system reduces the gap between water demand and water supply; this gap is caused by the time needed for the irrigation water to travel in the system or by delays of information transfers. The maximum volume of a regulating reservoir is determined by the physical structures of a canal/river system and by water demand fluctuations.*

It takes time for flows to go down an open channel. Decreases of water demand, caused by rainfall or other factors, after irrigation water has been released from intake facilities or reservoirs results in a water supply that exceeds demand. The excess water then overflows at spills in the canal system or drains out from farm plots. Water storage near demand points is a useful solution to the storage of excess water supplied and the need to reduce water losses.

Regulating reservoirs are storage facilities installed in the middle of a canal system. Regulating reservoirs are widely used in pipeline irrigation systems. However, they are also useful facilities in open channel systems.

The necessary capacity of the regulating reservoir is calculated as the product of travel time from an upstream reservoir to a point and the maximum water demand at the point. The desired capacity may be occasionally too large for construction to be feasible, but regulating reservoirs with smaller capacities are nevertheless effective in reducing water losses and increasing irrigation efficiencies.

With careful operation, a cross-regulator can be used as a regulating reservoir (see page 46). The canal system itself also works as a regulating reservoir in low-lying areas (see page 20).

### 5.2 Installation of cross-regulators

*The main function of a cross-regulator is to regulate the water level in canals. Weirs are used as a substitute for cross-regulators if there is enough hydraulic head.*

Cross-regulators are set up to stabilise the water level in a canal for stable water diversion. One of the functions of a cross-regulator is to keep the upstream water level constant. It enables diversion to lower canals, thus controlling the water to any flow rate in the canal (Figure 5.1). Installation of a cross-regulator can reduce the need for maintenance water (see page 28). Cross-regulators also have other functions (see page 46).

There are several types of gates, including manual gates, automatic gates, and weirs used as cross-regulators. The type of gate used is determined by examining their function, ease of operation, and total cost.

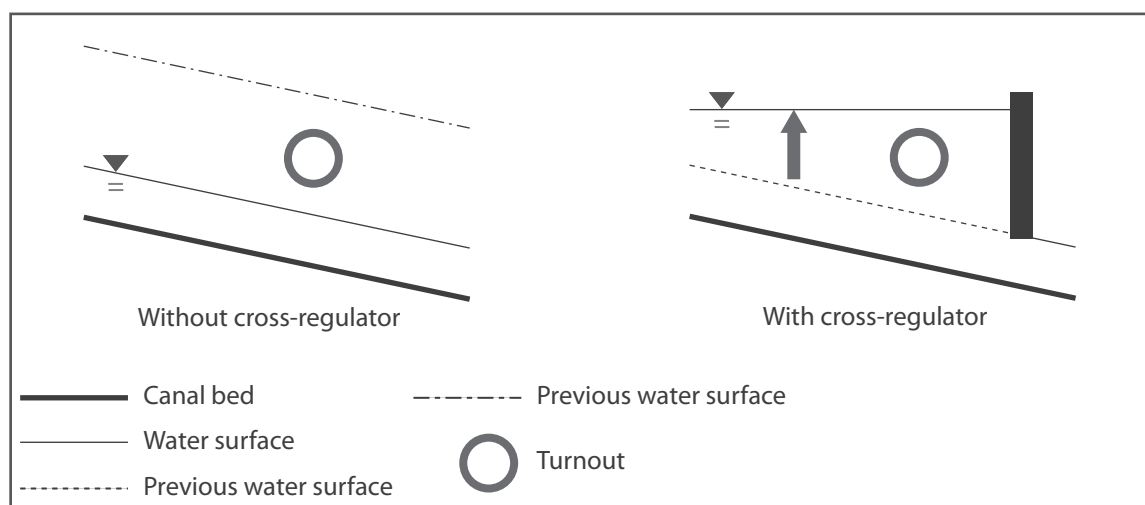

Figure 5.1 Use of a cross-regulator to improve smooth diversion of water

### Long-crested weir

Although cross-regulators are very useful for keeping the water level constant and reducing water losses, they can be costly and they need careful maintenance. If there is enough hydraulic head around the turnout, a long-crested weir can be used as a cheap and simple substitute for cross-regulators to maintain the water level of a canal. However, installation of a weir generally brings disadvantages to downstream turnouts. Upstream turnouts should be operated strictly so as not to divert more water than planned.

## 5.3 Improvement of canal systems

*Main or secondary canals without direct turnouts help reduce water level fluctuations, thus facilitating the operation of the canal system. The canal lining is also effective in reducing water losses in an irrigation canal system.*

Uncontrolled flows and direct turnouts make canal operations complicated. One way of solving these problems is to improve the canal system.

## Uncontrolled flows to irrigation canals

Natural streams or drainage canals sometimes flow in irrigation canals. Runoff from adjacent lands may also drain into irrigation canals. This uncontrolled flow is harmful to the safety of irrigation facilities. Natural streams and drainage canals need to be separated to reduce the damage.

However, such additional flows can act as useful water resources if they are monitored appropriately (see section 6.1) or if improvement of the canal system allows the safe use of uncontrolled flows.

Connection of natural streams through control facilities such as the intake gate illustrated in Figure 5.2 is a recommended strategy for the use of water resources and avoidance of problems with uncontrolled flows.

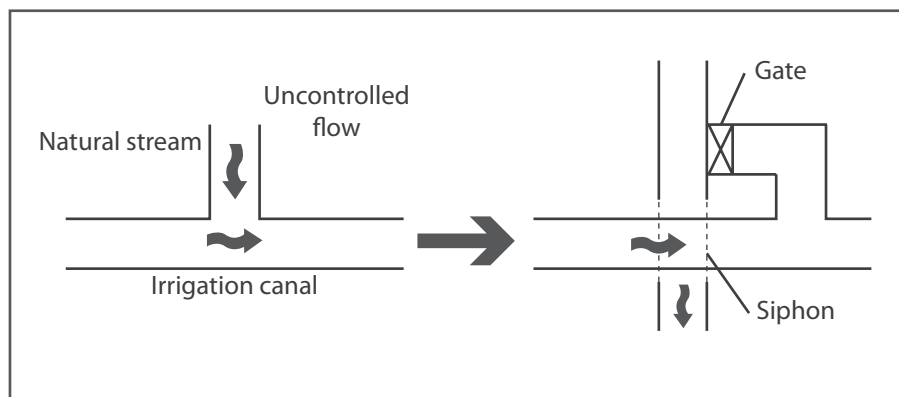

Figure 5.2 Control of natural flows

One method of controlling natural inflows is to divide the irrigation canal and the natural stream. Natural flow is taken into the irrigation system through a gate during a water deficit period.

## Direct turnout

Irrigation water is usually diverted to farm plots from tertiary canals. On occasion, however, a diversion is made directly from a main or secondary canal. This is called a direct turnout. Turnouts to farm plots are usually operated by individual water users (farmers). Although the flow rate of each direct turnout is small compared with the flow rate of a canal, the total flow from direct turnouts in a canal is not negligible.

For suitable water distribution, it is useful to control all flows into or out of main or secondary canals. Main turnouts, such as turnouts for secondary canals, are under the control of operators. Direct turnouts, however, are not usually controlled by the operator. Discharges from direct turnouts sometimes generate unexpected water flow fluctuations in the main or secondary canals; this may cause deficiencies in the water supply to tertiary canals and farm plots or lead

to water losses through spillage from canal systems (see page 39). Therefore, direct turnouts should be controlled by the irrigation project, but it is not practical for operators to manage all direct turnouts. Improvement of the canal system or formation of a WUA (see section 4.1) is effective in controlling direct turnouts.

Another solution is to eliminate the direct turnouts. If these turnouts were diverted not from main or secondary canals but from tertiary canals, serious water fluctuations in the main or secondary canal would be avoided. Therefore, construction of tertiary canals along main or secondary canals to eliminate direct turnouts (Figure 5.3) is a solution.

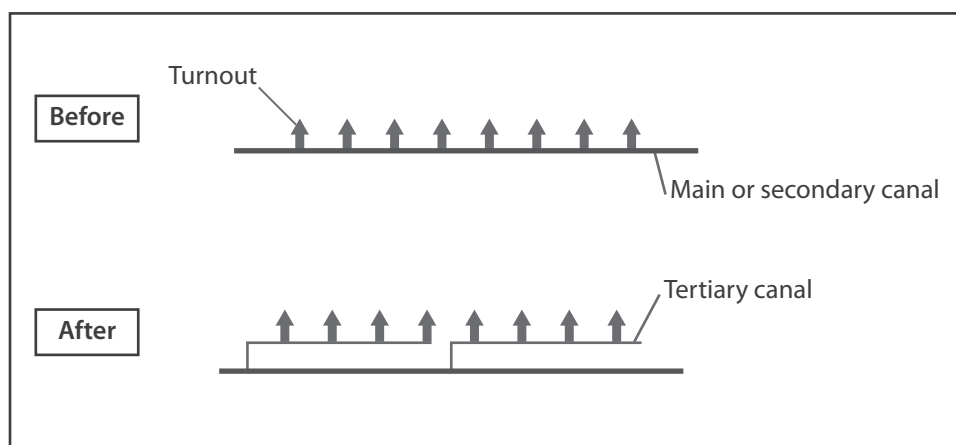

Figure 5.3 Elimination of direct turnouts through the use of tertiary canals

## Lining

Irrigation canal lining is an effective way to reduce leakage and evapotranspiration from adjacent plants and soil. It can also prevent the decrease in canal capacity caused by silting.

## 5.4 Construction of tertiary canals

*Construction of tertiary canals enables an irrigation system to give quicker and simpler water delivery as compared with plot-to-plot irrigation systems, thus increasing irrigation efficiency. The number of spill points from farm plots may increase, however, thus decreasing the irrigation efficiency if there is not careful water management. These two contradictory impacts need to be carefully examined when construction of tertiary canals is planned.*

Plot-to-plot irrigation systems can be problematic in terms of water distribution (see section 4.4). Construction or expansion of tertiary canals can facilitate the water distribution to each farm plot and help solve these difficulties.

However, we should recognise both the advantages and disadvantages of tertiary canal construction or expansion. The first positive effect of a tertiary canal is the reduction of delivery time of water to farm plots. Under plot-to-plot irrigation, water can be delivered to a farm plot only after the upper farm plots have been filled. Construction or extension of tertiary canals reduces the number of farm plots passed and reduces the travel time (Figure 5.4).

The second positive effect of tertiary canals is that plot-to-plot routing is shortened and simplified, making it easier to clearly see the problems preventing water to flow to farm plots (see section 4.4).

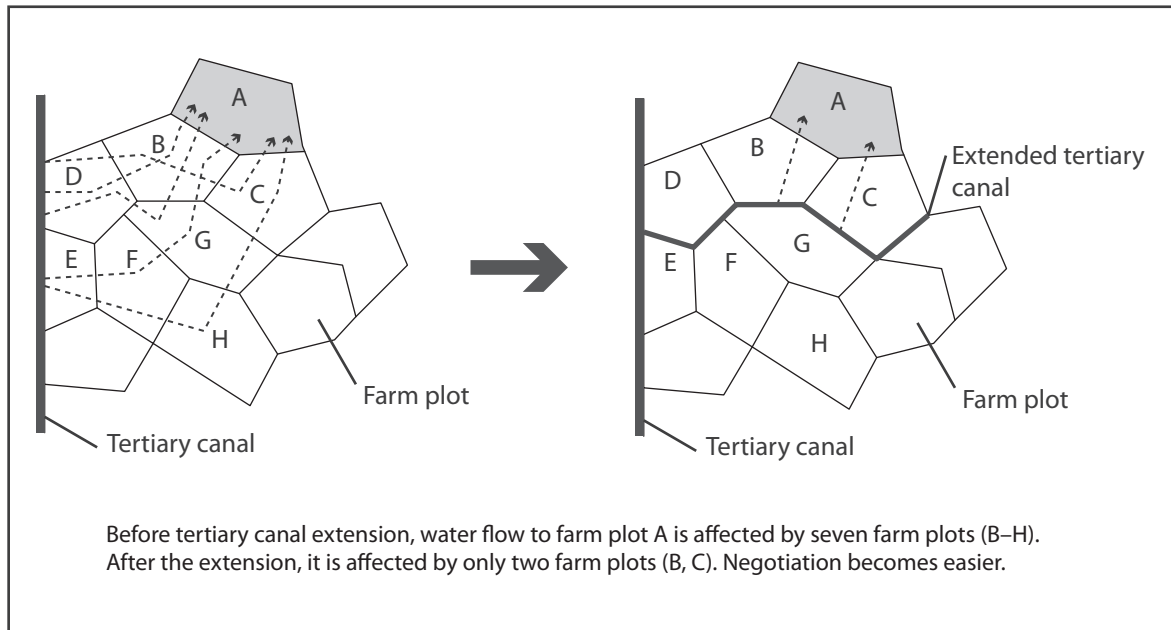

Figure 5.4 An example of tertiary canal expansion to reduce delivery time

One negative effect is an increase in the number of spill points. Water losses in farm plots are caused mainly through spills (drainage). The increase in number of spill points will lead to irrigation water loss unless careful water management practices are conducted at each farm plot.

The effects of tertiary canals should be carefully examined before the construction or expansion of these canals (Figure 5.5).

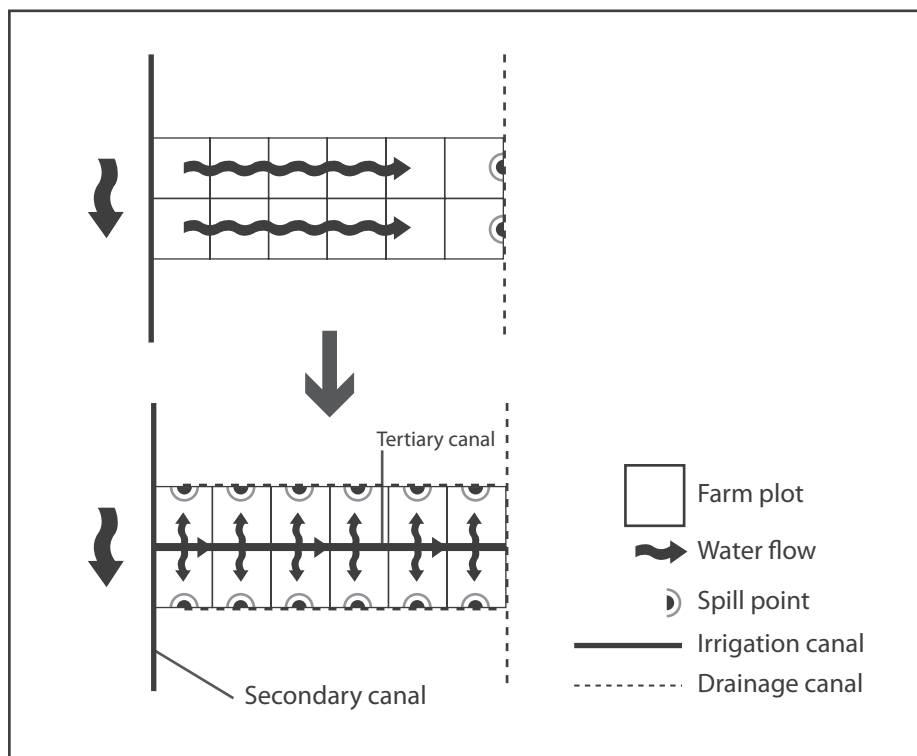

Figure 5.5 Increase in the number of spill points through tertiary canal expansion

## 5.5 Installation of remote monitoring and control systems

*Introduction of remote monitoring and control systems reduces irrigation losses through the acceleration of responses to changes in water demand in a project.*

Irrigation facilities have been individually monitored and operated at a site. However, it is often desirable to operate facilities with a minimum number of staff in a comprehensive manner. Introduction of remote monitoring and control systems can permit this.

The purposes of having a remote control and monitoring system are:

- equitable water distribution
- minimisation of water loss
- saving on labour input
- disaster prevention
- data collection.



A control centre and on-site stations can communicate by wireless means, a dedicated communication line, and a commercial line.

A remote monitoring system collects various data (e.g., on rainfall, water levels, and water discharges). The collected data are displayed by digital or analogue meters on graphic panels (panel graphs), and operators can observe the data at the control centre. The operators can then use these data to decide how to operate main irrigation facilities such as regulators, important diversions, and intakes. Facility operations are executed via an operation console.

Figure 5.6 shows the control centre of a remote monitoring and control system. Console desks and a graphic panel can be seen. In more modern systems, however, these items are replaced by normal computers.



Figure 5.6 A centre for remote monitoring and control

We may leave the details to other literatures such as ‘Irrigation water management and small scale hydropower generation in irrigation system in Japan, JACEM’.

## 5.6 Installation of automatic gates

*An automatic gate is very useful for stabilising water flows and achieving effective water management. It is used at cross-regulators, intakes, and turnouts.*

### **Automated cross-regulators**

Some projects have introduced gates at diversion points to mechanically keep upstream water levels constant. These types of gate are simple to operate: the manager just has to operate the intake and diversion gates wherever the discharge needs to be changed. The degree of opening of the diversion gate is determined only by its discharge.

The installation of automated cross-regulators is highly recommended, but the disadvantages mentioned below should also be noted to ensure effective use of these devices.

In an irrigation canal system, the upstream turnouts have advantages over those in the downstream branches. Especially if there are automated cross-regulators, sub-system diverted from the upstream turnouts can get all the water they want (Figure 5.7). This can result in downstream water deficits, but it will not occur if the turnout operators follow the canal operation plan or irrigation scheduling. If these plans are not followed, installation of automatic cross-regulators may cause downstream water shortages.



Figure 5.7 Automatic gate (control of water level upstream) accompanied by a manual gate

### **Computer-controlled automatic gates**

Automatic gates controlled hydraulically can be seen in many irrigation systems in the LMB. They are used mainly as intake gates or cross-regulators. Their functions are relatively simple—they open or close completely or keep water levels constant.

Another type of automatic gate is controlled by computer; not only can these gates control water levels, but the computer also controls the degree of gate opening and thus the degree of discharge through the gate. Such computerised systems can also realise even more sophisticated controls. Target values such as water level, flow rate, and degree of gate opening can be easily changed by pressing buttons on the control panel beside the gate. Gate opening can be made to occur slowly by using a timer to prevent hunting of gates. This type of automatic gate can also be used as a diversion gate at turnouts because it can control water discharge. Even if the water level in the canal fluctuates, the automatic gate can maintain the diversion flow rate. This type of gate is expensive, but it can be operated in a sophisticated manner.

## 5.7 Facilities for reuse of irrigation water

*Reuse of irrigation water should be promoted by the installation of appropriate irrigation facilities.*

Water consumption in farm plots takes place by evaporation and evapotranspiration. The remainder of the irrigation water goes downstream through infiltration from a farm plot surface, seepage through levees and drained water through spill points. Therefore, water users in downstream areas have the chance to reuse the water for irrigation via weirs or pumps. The runoff of water balance needs to be estimated to plan appropriate water reuse.

For example, if an irrigation canal is adjacent to drainage canals in a relatively flat irrigation system, pumps can lift water from the drainage canals to the irrigation canals (Figure 5.8, Figure 5.9). In this irrigation scheme, the water yield of a drainage canal is estimated by runoff analysis (unit hydrograph).

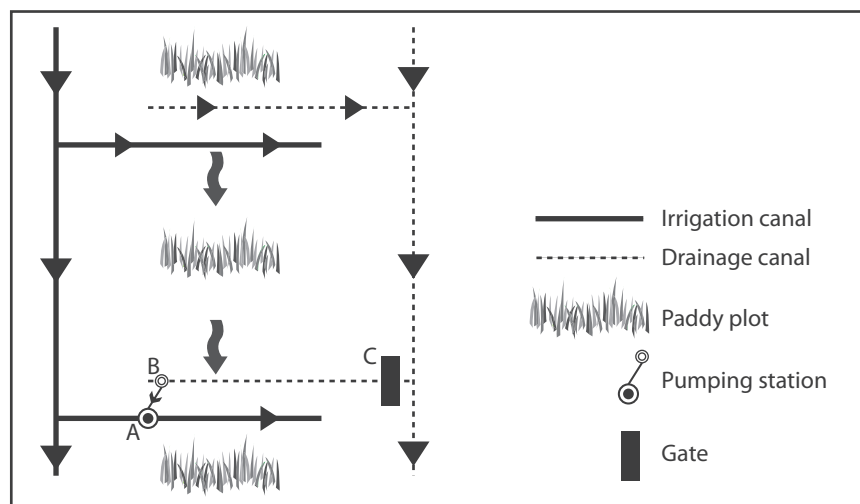

Figure 5.8 Water reuse from adjacent drainage canals

A pump station is installed at point A and lifts water from the drainage canal (at point B) to an irrigation canal. A gate at point C is closed to raise the water level when water reuse is conducted.

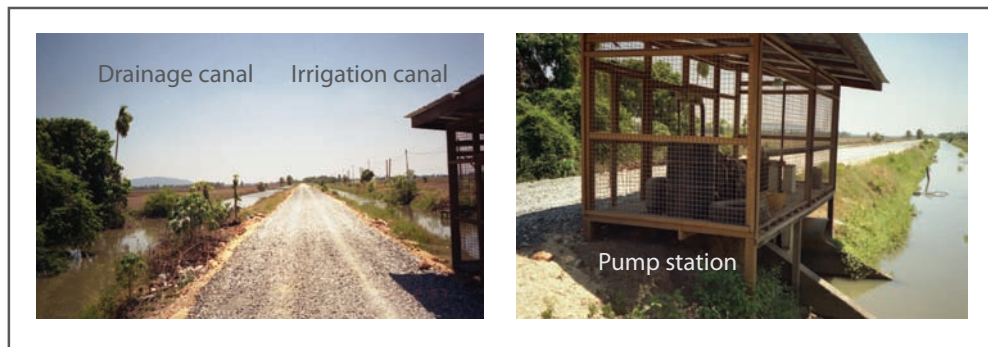

Figure 5.9 Drainage and irrigation canals and pump station for water reuse

## 5.8 Construction of regulators and canal improvement in low-lying systems

*Expansion of canals or installation of control structures resolves uneven water distribution in low-lying irrigation systems. Construction of regulators increases the area that can be irrigated by gravity in low-lying regions.*

It is important to keep water levels at targeted heights over the whole irrigation system in low-lying irrigation systems. The elevation of farm plots, however, varies even within the same irrigation system. A water level that is desirable for some farm plots may cause undesirable inundation of other farm plots. In this case, one irrigation system is divided into several sub-systems to set appropriate water levels for the farm plots. Water level control structures such as cross-regulators are constructed at the border between these sub-systems. The target water level in areas at higher elevations is raised (from A to B) in tidal irrigation systems, and the target water level in areas at lower elevations is decreased (from C to B) in flood-prone irrigation systems (Figure 5.10).

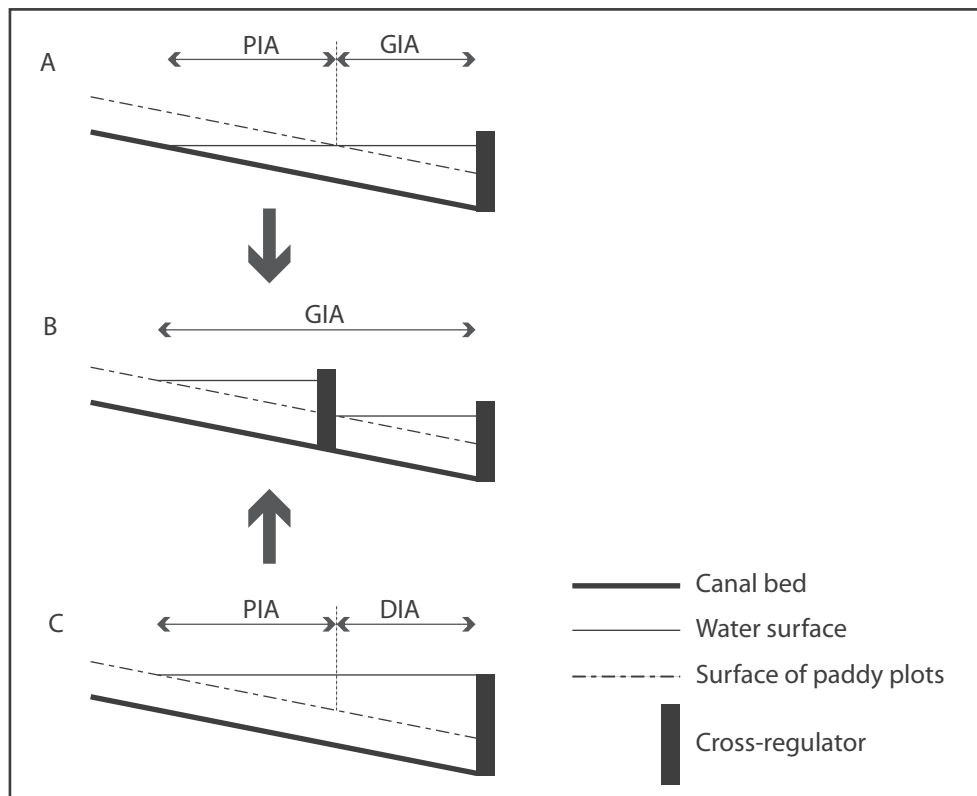

Figure 5.10 Construction of regulators for expansion of a gravity-irrigated area

*GIA*: gravity irrigation area; *PIA*: pump irrigation area; *DIA*: deep inundated area

Since the canal slope is very flat in low-lying irrigation systems, the flow velocity is very small. Sometimes not enough water can be delivered to the end of the irrigation system. In this case, the canals need to be expanded or structures that act as obstacles to irrigation water flow need to be removed.

An inundation analysis is very useful when improvements to physical structures in low-lying areas are designed.

### Inundation analysis

There are several models for calculating inundation (flood) situations. They usually employ unsteady flow analysis. These models generate accurate estimations, but the simulation is time-consuming.

The diffusive tank model proposed by Hayase *et al.* (1993) is an analytical method based on the equation of non-uniform flow (steady flow). Taking account of river junctions and drainage facilities, the river network is divided into many reaches. Each reach is considered to be a river tank. Taking into account their connections with rivers, several paddy plots are lumped into one plot. Each plot is dealt with as a paddy tank. The basin is expressed in a schematic diagram composed of river and paddy tanks (Figure 5.11).

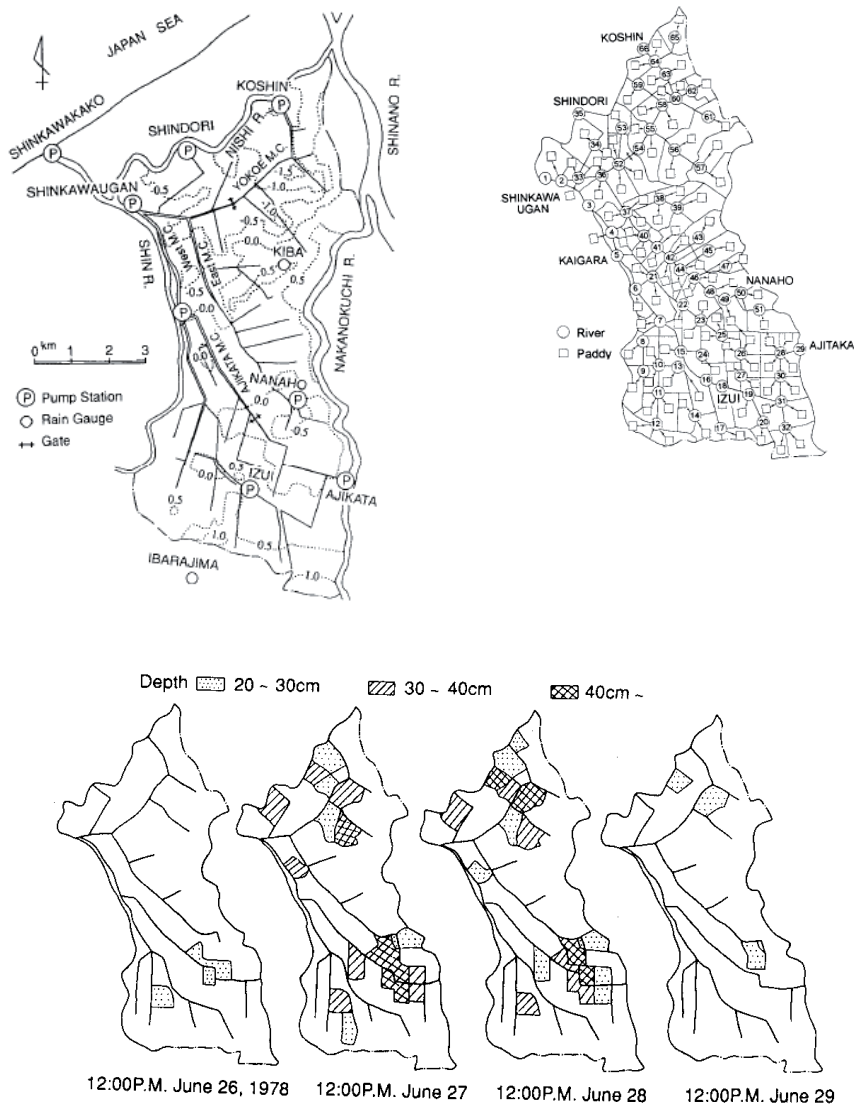

Figure 5.11 Target basin, schematic diagram, and results of inundation analysis

Water levels at canals and farm plots (inundation depths) are calculated, along with the situation of irrigation facilities and their methods of operation. The results of facility improvement and gate operation can be estimated through this model.

## 6. Managerial and technical aspects

### 6.1 Monitoring

*Real-time monitoring is useful for identifying changes in water demand and supply and responds to such changes immediately. At the same time, monitoring is used to improve future water management. Accumulation of long records is necessary to create more appropriate water management rules.*

#### **Function of monitoring**

Monitoring is useful at three stages: canal operation, irrigation scheduling, and seasonal irrigation planning. In addition, real-time monitoring is needed for appropriate canal operations (see section 3.4). Turnouts and cross-regulators should be operated appropriately in accordance with water levels or the flow rates of irrigation canals (see page 39 and 46, and section 5.3). Water flows of drainage canals are usually neglected in water management, but attention to these flows is useful for saving water (see page 32). Water supply may be reduced or cancelled in response to unexpected rainfall, and this reaction can save water to meet future water demands.

Monitoring can be reflected in the water distribution or irrigation scheduling (see section 3.1 and 3.2). Rainfall, standing water in paddy fields, water delivered to each area of an irrigation system, storage volume of reservoirs, crop area and crop type, progress in land preparation, transplanting or harvesting, and water users' requests should all be measured or surveyed to set up a water distribution plan for the next irrigation period.

Long monitoring records are useful for establishing a seasonal irrigation plan (see Chap. 2) or tertiary water management (see Chap. 4). Crop yield, farmers' income, and number of water users are also useful information. They are used to evaluate the current irrigation management and can be reflected in a future irrigation plan.

#### **Placement density of rainfall gauges**

Rainfall is an important meteorological factor for effective water management. Irrigation projects with reservoirs contribute to the stabilisation of rainy season rice cropping, but the water storage capacity of reservoirs is sometimes not sufficient for an additional dry season cropping. Therefore, it is necessary to control the release of water and try to reduce the amount of water supplied through careful monitoring of the actual average rainfall over the area. Average rainfall is calculated from point rainfall amounts measured by rainfall gauges. The

accuracy of average rainfall depends on the density of placement of these rainfall gauges. Figure 6.1 is an example of the relationship between accuracy and density of placement of rainfall gauges.

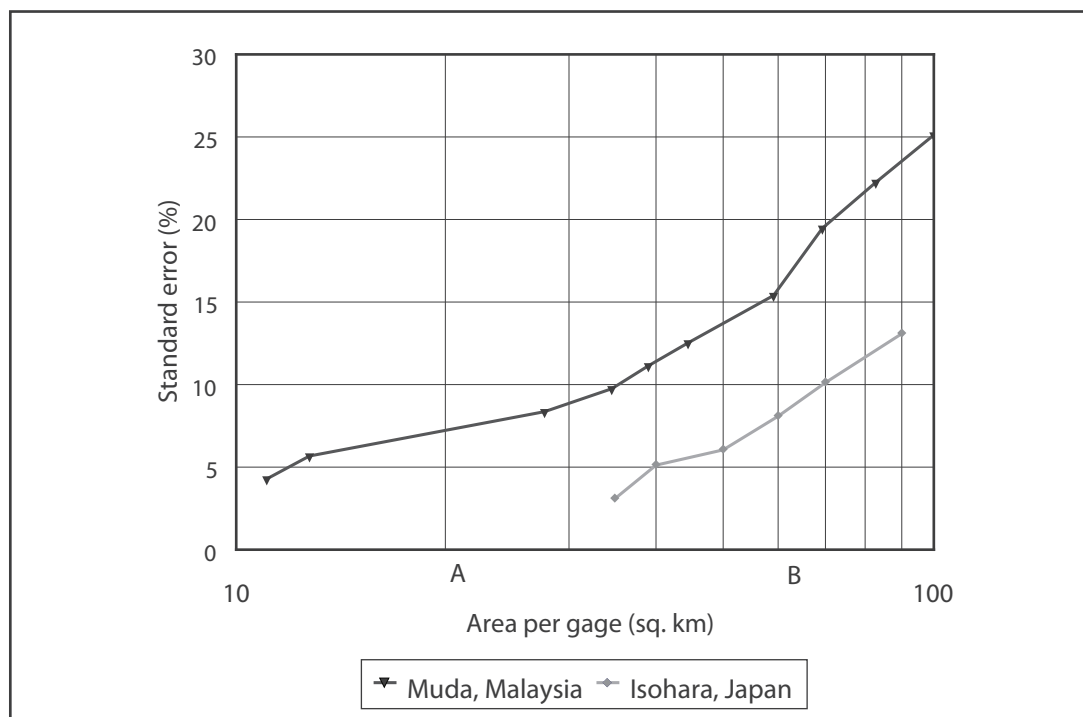

Figure 6.1 Density of rainfall stations and accuracy of estimated rainfall

## 6.2 Water requirement

*The concept of water requirement estimation is the same as that used for seasonal irrigation planning and irrigation scheduling. Even if the same method is used for irrigation project planning, related factors such as irrigation area and irrigation efficiency should use latest values.*

Water requirements may be examined at the planning stage of each irrigation project. The same method can be used at the O&M stage to estimate water requirements. Water requirements can be calculated to establish a seasonal irrigation plan (see section 2.1) or for irrigation scheduling (see section 3.1). Important points for estimating water requirements in the O&M stage are to use the current values instead of the original estimated values used in the previous stages.

Irrigable area, canal system, or crop pattern later in this stage may not be equal to those at the design stage. Rainfall and other climate factors vary from year to year. The values for current irrigation efficiency, unit water requirement, effective rainfall, or water requirement for pre-



saturation used for the design stage should be examined and revised. Figure 6.2 is an example of comparisons between the effective rainfall in the design and the observed effective rainfall.

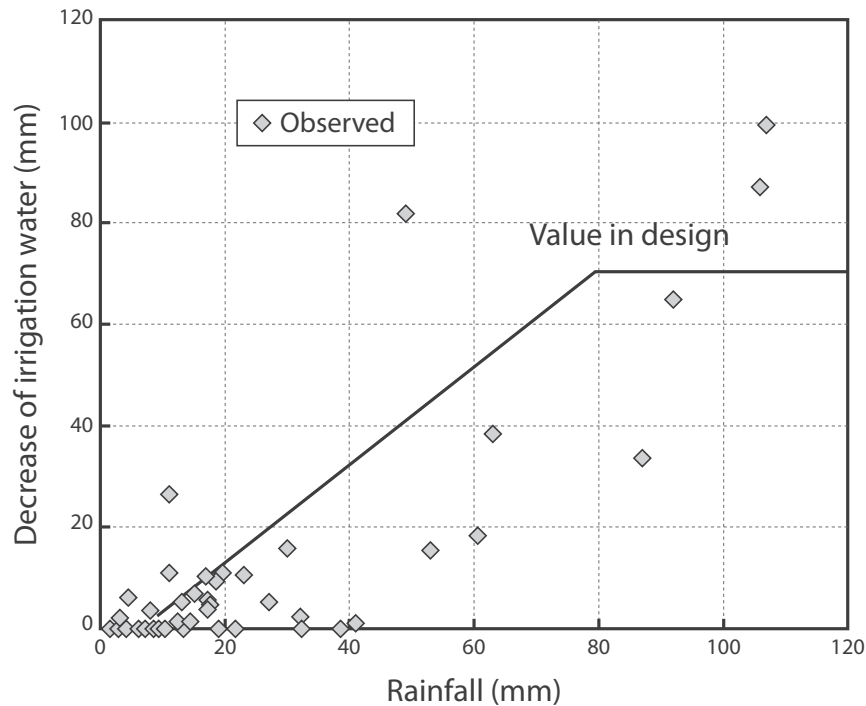

Figure 6.2 Design and actual effective rainfall

Water requirements may be calculated daily, weekly, or monthly. In Southeast Asian countries, because most of the irrigated areas are paddy fields, which can store water in the soil layer and as standing water, large amounts of water can be carried over from one irrigation period to another. The amount of irrigation water required for land preparation (pre-saturation water, transplanting water) varies widely depending on the soil moisture levels in the farm plots. To explain these phenomena well, a method of estimating water requirements should deal with water stored in the farm plots.

### Irrigation water model

An irrigation water model can be used to estimate water requirements by considering water storage in a farm plot.

Irrigation efficiencies (conveyance efficiency, application efficiency) are estimated by irrigation project staff, along with effective precipitation to irrigated fields. If data are available, a water balance model is applied to pilot projects to reveal efficiencies and effective precipitation.

Water balance in paddy plots can be shown by the following equation:

$$\Delta S = P + WS - ET - If - D$$

Where:

S: water storage in paddy plot

WS: water supply

ET: evapotranspiration

If: infiltration

D: drainage

P: rainfall (see Figure 6.3)

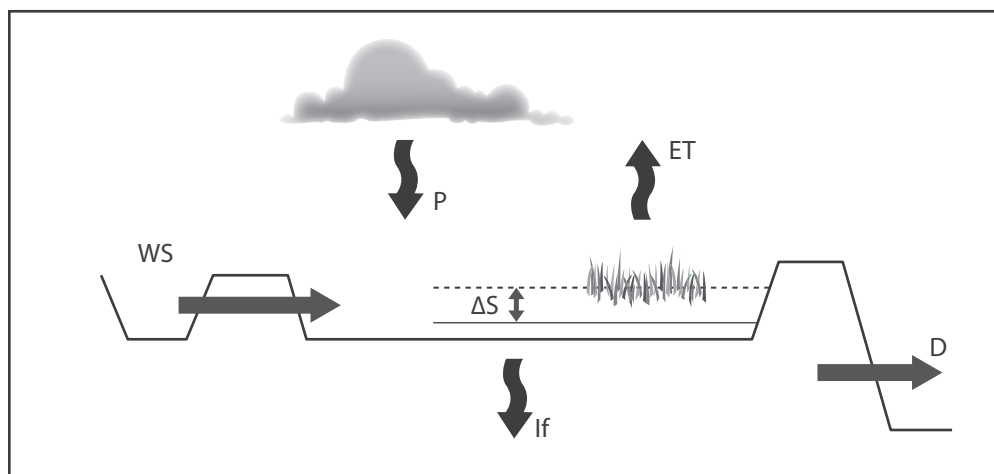

Figure 6.3 Components of water balance in a farm plot

These factors are expressed in volume per unit area. Water storage includes standing water on paddy fields and available soil moisture. Water storage is calculated by the water balance equation periodically after the initial water storage is given at the beginning of each season. Two water depths are introduced to calculate the water balance: one is MWL (maximum water level) and the other is TWL (target water level).

MWL is the maximum depth of water that can be stored in the paddy plot and depends on the height of the levee. Drainage may occur when the water level exceeds the MWL. TWL is the depth that should be maintained during the cropping season. When the water level in the plot is below the TWL, water must be supplied to the plot.

The water balance model is evaluated by comparing the calculated values with the observed values. Water storage (water depth), drainage, and water supply are usually not measured in each paddy plot. Total water supply to the target area is the only factor that is measured. The observed and calculated water supplies in the target area are compared to evaluate the water balance model.

Evapotranspiration is the reference evapotranspiration ( $ET_{ref}$ ) multiplied by the crop coefficient for rice ( $K_c$ ). The crop coefficient depends on the variety.

$$ET = K_c ET_{ref}$$

Water requirements for the project area are calculated from the water supply to the plot by the following equation:

$$WS_{CP} = \sum_j WS_j \times A_j / IE \times 10$$

Where:

j: index of crop stage

WSCP: area water supply (m<sup>3</sup>)

WSj: water supply for a plot with cropping calendar j (mm)

Aj: area of paddy field with cropping calendar j (ha)

IE: irrigation efficiency

The timing of irrigation seasons is greatly staggered. Cultivation in the earliest paddy plot starts months in advance of the latest dry cropping plot. Information about the area of paddy fields on each cropping calendar is collected. Water requirements calculated for each cropping area are multiplied by the area and divided by the irrigation efficiency to obtain area water supply.

### 6.3 Organisation

*Participatory irrigation management (PIM) generally contributes to the improvement of irrigation efficiency. However, some PIM activities are not directly aimed at improving canal operations, and irrigation efficiency may temporarily decrease unless appropriate measures are taken.*

WUAs play important roles in formulating the procedures used to establish seasonal irrigation plans (see section 2.1), as well as in water management (see Chap. 4) and maintenance (see section 6.4) of tertiary canals. WUAs help water users' more reliably practice irrigation water management.

The WUA is usually set up at the time participatory irrigation management (PIM) is introduced. PIM has been implemented widely in Southeast Asian countries. We may leave the details to other literatures such as 'Guidelines for on-farm irrigation development and management in Monsoon Asian countries, JIID (2008)'.

However, the purpose has not always been to improve irrigation efficiencies. Occasionally the objective of PIM is irrigation management transfer (IMT) for sustainable irrigation management. Some water management procedures implemented by national or regional governments have been transferred to WUAs. IMT may result in an improvement in irrigation

efficiencies in the long run, but it can have some negative short-term effects. Figure 6.4 shows examples in which irrigation facilities were simplified to facilitate IMT.



Figure 6.4 Irrigation facility changes as a result of IMT

*Left:* Gates have been removed at this diversion work to eliminate the need for operation and make water management easier.  
*Right:* The recording gauge installed in the white box was replaced by the project staff's gauge at this turnout because the latter is easier for the WUA to use.

Many factors impede IMT, including the lack of knowledge of water management techniques among WUA members. If IMT is the main objective of PIM activities, then water management can be simplified by procedures like those shown in Figure 6.4. However, this simplification may lead to temporary depletion of irrigation efficiencies. One countermeasure is to train WUA members and increase their members' skills in water management from the beginning of PIM activities.

## 6.4 Role of maintenance

*Irrigation facilities should be kept in good condition. The roles of the parties involved in maintenance need to be described.*

Seepage and leakage from irrigation canals are water losses. The extent of these losses depends on the condition of the canals. Deterioration of irrigation facilities also makes water distribution and canal operations difficult. A maintenance program needs to be set down before the irrigation system enters service.

Maintenance practices may be shared with related parties, such as national or local governments, irrigation project offices, and water users. Very costly maintenance practices such as rehabilitation of main canals and structures like gates are likely to be implemented by governments or projects. In contrast, maintenance practices that are less costly but occur frequently are usually implemented by water users or WUAs. Tertiary canal cleaning is typically carried out by farmers.

– Rehabilitation

Long-term rehabilitation programs should be set up before the construction of an irrigation system is completed. The condition of the irrigation facilities should be examined before each irrigation season or in a scheduled survey.

– Canal cleaning

Before the irrigation season starts, the canal condition should be examined. If silt and weeds are observed, they should be removed because they prevent water flow or consume water through evapotranspiration.

Tertiary canals in many irrigation projects are usually maintained by the WUA or water users. The start of water supply requests tertiary canal cleaning in some irrigation schemes.

## 6.5 Institutional system design

Most water management improvements are implemented in each irrigation system by project staff and water users. Some improvements, however, need the help of legislation, which is a very strong and useful tool for solving a wide range of problems. These laws may involve many people who are not users of the irrigation system and may influence factors other than water use. Other factors, such as social background, should be examined when legislation is considered to improve water management.

### **Water rights systems**

*Water rights systems are important to resolve conflicts between upstream and downstream water users at a tributary.*

Reliability of irrigation water supply is necessary to prevent vandalism such as water theft. The guarantee of water allocation is important for maintaining reliability (see Chap. 2). Water resources should be preserved for the implementation of seasonal irrigation plans. New water users may threaten current stable water use if there is no water rights system or water resources plan.

## Restrictions on land use

*Scattering of irrigated areas results in decreased irrigation efficiency. Restriction of land use may prevent the generation of scattered irrigated areas.*

Expansion of urbanisation can be found in many regions of Southeast Asian countries. Urbanisation often leads to the conversion of irrigated land to other land uses. It is difficult to deliver water to scattered irrigated areas efficiently (see page 13); sprawling land conversion thus results in decreased irrigation efficiencies. Rules or legislation restricting changeover of land use is effective for efficient irrigation management.

## Rules for water quality protection

*In tidal irrigation systems water is circulated within a scheme. This practice contributes to high irrigation efficiency, but it causes degradation of water quality. To maintain water quality, stored water should be occasionally drained from the system. If this amount is reduced and recycled, additional diversions to top up drain water can be reduced. Therefore, water quality control can reduce the additional water demand.*

An irrigation canal functions as a drainage canal in tidal irrigation systems (Figure 6.5). In such a system, the irrigation system reuses water (see page 20). Urban sewage or drainage water from farm plots may flow into a canal system from which irrigated water is taken for application to other farm plots. Fertilisers, chemicals, and effluents cause water quality to deteriorate in the canals. Water that is declining in quality may need to be diluted to prevent it from becoming unsuitable for irrigation use. Therefore, maintenance of water quality in a canal system is useful for efficient irrigation. Around the world there have been many attempts at legislation for the conservation of water quality. Such laws have restricted the application of fertilisers and other agricultural chemicals and have regulated sewage disposal system construction and placed constraints on wastewater disposal.

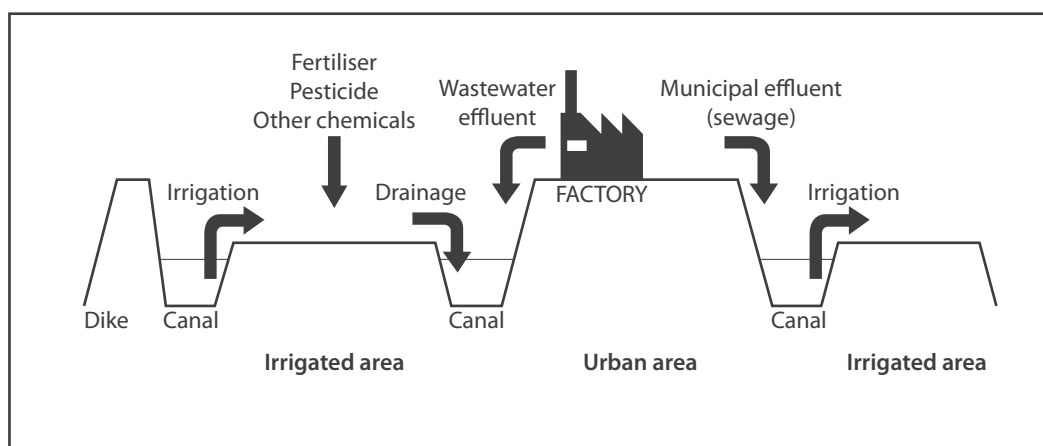

Figure 6.5 Water and material cycles in low-lying areas

### **Substitute lot planning in land consolidation**

*Substitute lot planning is useful for facilitating the construction of tertiary canals.*

As mentioned, the improvement of plot-to-plot irrigation systems by the construction of tertiary canals is effective in improving irrigation management (see section 5.4). Some farmers who lose their farm plots, however, may oppose tertiary canal construction. This is an obstacle to promoting the construction of tertiary canals, and compensation of these farmers is one way to overcome it.

Substitute lot planning is a legal method of exchanging lots in land consolidation, land reclamation, or ditch and dike projects. In a substitute lot plan, the areas of related farm plots are decreased equally to generate the land for tertiary canals. Re-plotting is implemented in these plans and the farmers are allocated new farm plots in place of their old plots.





## References

- Hayase (1999) Runoff analysis of inundated areas. *Advance Paddy Field Engineering*, (Editorial committee of advanced paddy field engineering), Shinzan-sha Sci. & Tech, Tokyo, pp.122-133.
- Isawaki,K. (1981) Study on water arrival time in irrigation canal systems. *Bulletin of the National Research Institute of Agricultural Engineering*, no. 28, pp.53-107 (in Japanese).
- JACEM (1989) *Irrigation Water Management and Small Scale Hydropower Generation in Irrigation System in Japan*, Japan, 42 pages.
- JIID (2007) *Guidelines for On-farm Irrigation Development and Management in Monsoon Asian Countries*, 177 pages.
- Kaneko,R. (1973) *Agricultural Hydrology*, KYORITSU SHUPPAN, Tokyo (in Japanese).
- Naibu (2002) *Historical Progress of Agricultural Development in Tropical Lowland: A Case Study on Establishing Process about Double Cropping of Paddy in Muda Area of Malaysia*, JIRCAS, Working report no. 28, 113 pages.(in Japanese).
- Ren,Y.,Yamaoka, K.,Tommosho,T., Satoh,M.(2005) An analysis of participatory irrigation management in the Dunjang irrigation district, China. *Proceedings of annual meeting of The Japanese Society of Irrigation, Drainage and Reclamation Engineering*, pp.962-963 (in Japanese).
- Shimizu,K., Masumoto,T., Taniguchi,T. (2006) Development of a distributed hydrologic model for assessing effects of agricultural water use on water circulation in paddy-dominant basins, *Proceedings of International Conference on Mekong Research for the People of the Mekong*, Chaing Rai, 18-21 October 2006, Thailand, pp.103-109.
- Tomosho,T., Horikawa,N., Ren,Y., Yamaoka,K. (2007) Developing stages of the functions of participatory irrigation management organizations. *Proceedings of International Workshop on "Assessment of Changes in water cycle on food production and alternative scenarios –implications for policy making"*, Tsukuba, 22 November 2007, pp.95-98.
- Tomosho,T., Yamaoka,K. (2006) Introduction of small scale irrigation canal management based on farmers' water customs: A case study in flat paddy field area in Cambodia. *Journal of Japan Rural Planning Association*, 25(1) pp.28-34 (in Japanese).

Yamaoka, K., Horikawa, N., Tomosho, T. (2004) Water use efficiency and economic externalities of farmer-group-initiative participatory irrigation management in rice paddy agriculture in the Asian Monsoon Region. *Proceedings of the 7th International Seminar on PIM Tirana, Albania*, 13-18 June 2004, pp1-8.

## Appendix: Case study

The scheme analysis by the guidance is conducted at the pilot project sites in each member country as a case study.

### 1. Pilot project sites

NMC/Line agencies of each country decided on one appropriate pilot project site (irrigation scheme) to conduct field observations respectively in 2006. The tentative selection criteria are 1) representative of agro-ecosystem and irrigation typology of the basin, 2) accessibility, 3) appropriate size, 4) availability of relevant information.

Four pilot project sites are selected according to the above criteria.

- Kamping Pouy project, Battambang Province, Cambodia
- Num Houm project, Vientiane Province, Lao PDR,
- Huay Laung project, Udon Thani province, Thailand
- Gocong project, Tieng Giang Province, Viet Nam

Two field visits were made to four pilot project sites; a preliminary field visit is the beginning of this Stage and another field visit at the end of the rainy cropping season accompanied by detailed discussion with Line agencies.

#### – Num Houm

The Num Houm irrigation project is gravity irrigation system located about 35 km north of Vientiane on road number 13. The command area covers Naxaythong and Xaythany districts with total planned command area of 2,400 ha. The benefit families are in 17 villagers with 19,879 persons.

The purpose of the scheme is to supply water mainly for dry season cultivation and supplementary for wet season cultivation. The command area is classified into 93% of paddy crops, 5% of fishpond, and 2% of cash crops.

The reservoir has catchments area of 108 km<sup>2</sup> with annual inflow of 149.5 million cubic metres (MCM). The maximum storage is 60 MCM (active of 54 MCM, and dead of 6 MCM.)

The water is supplied by earth-open canals with total length of 60.635 km, of which the main canal is 9.300 km, the secondary canals are 30.014 km long, the tertiary canals are 16.827 km, and the quarterly canals are 4.500 km. There are 367 structures in total.

The project is operated by Num Houm project office belonging to the Agriculture and Forestry Department of Vientiane capital under the Ministry of Agriculture and Forestry.

— Huay Luang

The Huay Luang irrigation project is located in the Northeast of Thailand or the East of Udon Thani Province, Kud Jab district at the topographical coordinates of 17.3N latitude and 102.0E longitude, about 7.5 km west of Udon Thani city along the road No.210 between Udon Thani and Nong Bua Lamphu provinces. The maximum storage of the reservoir is 135.6 MCM and the dead storage is 6.6 MCM. The project managed by Huay Luang irrigation project office under the Royal Irrigation Department (RID).

The irrigation management survey is mainly implemented in irrigation system of left main canal (LMC). The canal network is divided into 4 irrigation management zones. The command area of LMC is 7975 ha.

— Kamping Pouy

The system was initiated during 1975-1979 with national budget. The project is located in Ta Ngen Village, Ta Kream Commune, Banan District of Battambang Province, approximately 32km west from Battambang town.

The maximum storage is 90 MCM. Recently the diversion canal was constructed to deliver water from adjacent river (Mongkol Borey River) to reservoir. At present only the right main canal is in operation. The rehabilitation of the right main canal was divided into 3 zones with total area 2,850 ha. The project is owned by the Provincial Department of Water resources and Meteorology, Cambodia (PDWRAM).

— Gocong

The Go Cong project is one of the typical tidal irrigation projects in the Mekong delta region. The project is located in My Tho City, Tien Giang province around 100 km from Ho Chi Minh City. It was initiated in the early 1980s and completed in 1990. In 2001 the automatic measurement system for monitoring water level and salinity was installed. The project area covers 3 districts: Go Cong East, Go Cong West and Chogao district. The project area is bounded by a coastal line of 166.7 km including 21 km of sea dike on the east and Tien Giang River on the south. The project has command area of 54,000 ha and benefits 480,000 farmers in 3 districts. The project is operated by Irrigation Management Company (IMC).

## Terms for water users' association in pilot project sites

There are many terms to indicate water users' association. In the main text of this guidance, WUA is used to indicate this idea consistently. However, terms called in related project site are used in the appendix (Table 1) for readers' convenience.

Table 1. *Terms for water user's association*

Pilot project	Num Houm	Huay Luang	Kamping Pouy
Project		JMC	FWUC
Main canal	WUA		
Secondary canal	WUG	IWUG	
Tertiary canal	Sub-WUG	WUG	WUG
quaternary canal			SWUG

*WUA*: water users' association

*WUG*: water users' group

*Sub-WUG*, *SWUG*: Sub- water users' group

*JMC*: Joint management committee

*IWUC*: Integrated water users' group

*FWUC*: Farmer water users community

## 2. Seasonal irrigation planning

### Outline of seasonal irrigation plan (see 2.1)

Reliability of water management depends strongly on careful preparation of the seasonal irrigation plan. A seasonal irrigation plan should be set up in time for the start of the irrigation season.

Seasonal irrigation plans are determined in all pilot projects. It is established once a year in Num Houm project and Kamping Puoy project. In November, the irrigation plan for the dry season is examined in both projects. The irrigation plan for the wet season is not examined in Num Houm project. The same irrigation plan is applied every wet season. The irrigation plan for the wet season is not established in Kamping Pouy project. In Huay Luang project, seasonal irrigation plans are established twice a year, usually at the beginning of July and in December. They are the irrigation plan for the dry season and for the wet season. Although triple cropping system is applied in Gocong project, the seasonal irrigation plans are examined twice a year, before the dry season and before the wet season.

### Elements of the seasonal irrigation plan (see 2.1)

In general, the seasonal irrigation plan describes the area to be irrigated, the crops cultivated, the irrigation period, and the amount of water for irrigation.

– Num Houm

The irrigation plan for the dry season describes the area to be irrigated, the irrigation period and the amount of irrigation water. The area irrigated depends on water storage of the reservoir at the beginning of the dry season. The irrigation project is divided into two sub-systems, (i.e. upstream and downstream). The irrigation period is determined for each sub-system. The irrigation season is divided into three stages (the nursery stage, the transplanting stage and the growing stage). Flow rates of release from the reservoir are determined for each stage.

– Huay Luang

The irrigation plan for the dry and wet season describes the area to be irrigated, crops cultivated, the irrigation period and the amount of irrigation water. The area irrigated and crops cultivated depend on water storage of the reservoir for the dry season. The irrigation project is divided into several sub-systems referred to as zones. Elements of the seasonal irrigation plan are determined with regards to each zone.

– Kamping Pouy

The irrigation plan for the dry season describes the area to be irrigated. The area irrigated depends on water storage of the reservoir for the dry season. Irrigation water is supplied intermittently in this project site. The number of irrigation supply, its dates and the amount of irrigation water are also described in the plan.

– Gocong

The irrigation plan describes the irrigation period. Target water levels are described for the wet season. Withdrawing of saline water is discussed before the irrigation season.

### **Involvement of water users in the decision making process (see page 9)**

Water users such as farmers are involved in the process of decision making for the seasonal irrigation plan. Before the plan is drafted, water users' requests for the coming irrigation season should be surveyed. Once the plan is drafted, it needs to be agreed on by water users so that it can be implemented. Water users should be informed of the seasonal irrigation plan through organisations or the mass media to prepare for the coming irrigation season

– Huay Luang

Project staff investigate water resources and inform water users of them. Water users registered their cultivation areas. Area irrigated is determined by comparing the registered cultivation area with available water. Allocation of area irrigated is carried out in each zone. JMC (Joint Management Committee) are held to approve the irrigation plan. Representatives of water users are members of the JMC.

Water users are informed of the seasonal irrigation plan through bulletin boards and web-sites.

– Kamping Pouy

FWUC investigates water resources and calls for the meeting to inform WUG leaders of them. After WUG leaders discussed about the irrigation plan with water user, FWUC calls the meeting again to determine the irrigation plan. It is approved by the PDWRAM and implemented by them.

– Gocong

Meetings of the water council are held twice a year to determine the irrigation plan. The members are from IMC (Irrigation Management Company), department of agricultural rural development and local communities who represents water users.

Before the winter-spring season, pamphlets explaining the irrigation plan are delivered to water users.

### **Estimation of available water and water demand for irrigation (see page 10)**

Since water allocation is determined by comparing water supply with water demand, water supply and demand for the coming irrigation season need to be estimated before the seasonal irrigation plan is formulated.

– Num Houm

Water requirements are estimated as 18,000 m<sup>3</sup>/hr (1800 mm water height equivalent) per season. The storage volume of the reservoir is water sources for the dry season. This project neglects effective rainfall and discharge into the reservoir for estimating available water and water requirements for the dry season.

– Huay Luang

Water requirements are estimated by reference evapotranspiration, crop evapotranspiration coefficients, infiltration rates, effective rainfall and irrigation efficiencies. This project uses

monthly or weekly mean rainfall to estimate effective rainfall. This estimation is optimistic and risky. It is compensated by flexible water supply.

– Kamping Pouy

Water requirements are estimated as 20,000 m<sup>3</sup>/hr (2000 mm water height equivalent) per season. The storage volume of the reservoir is water sources for the dry season. This project neglects effective rainfall and discharge into the reservoir for estimating available water and water requirements for the dry season.

**Constraints on irrigation (see page 11)**

Crops cultivated, area irrigated, crop establishment, and starting date of irrigation will be limited or controlled if the water supply is inadequate.

– Num Houm

If the storage volume of the reservoir is less than 60 MCM, rotational water supply and constraints on area irrigated are implemented for the dry season.

– Huay Luang

Area irrigated and crops cultivated are restricted in this project in the dry season if the storage volume of the reservoir is not sufficient (Figure 1). Rice is the prevailing crop in this project. However, if not enough water is available in the dry season, rice cultivation is restricted. Other suitable crops apart from rice are recommended to be cultivated in the paddy fields. Method and starting date of rice establishment are not constrained because they cause yield reductions and water supply for weed control.

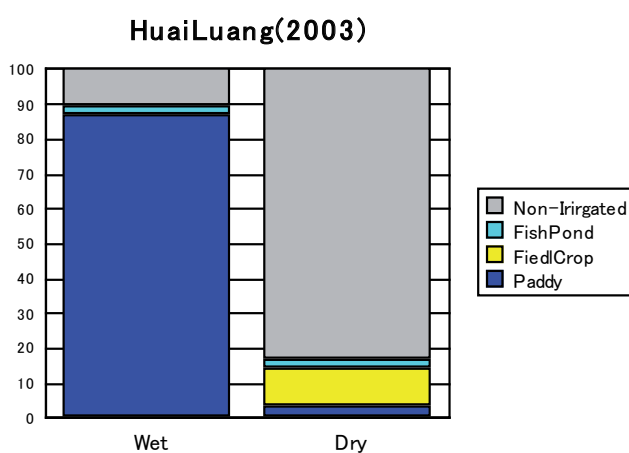

Figure 1 Irrigation area in Huay Luang project site (2003)



– Kamping Pouy

If the storage volume of the reservoir is not sufficient for the dry season irrigation, constraints on area irrigated are implemented.

– Gocong

Rice establishment was postponed in 1999, because of the wet season delay. The irrigation area is not constrained in this project site.

**Allocation of area irrigated (see page 13)**

Both convergence and equity should be considered in allocating the irrigated area when the total irrigated area in the system needs to be constrained because water resources are insufficient.

– Num Houm

If the area irrigated should be restricted, it is allocated according to the elevation of farm plots. It is converged upstream and the areas irrigated are not shuffled within the irrigation system in every irrigation season. Irrigated areas are converged but equity among water users is not achieved.

– Huay Luang

First, the irrigated area is allocated to each zone. Next, it is assigned to water users in the zone. Consequently, the irrigated area is scattered in the project site. On the other hand, equity in assigning irrigated areas to water users is achieved, because the seasonal rotations of irrigation areas are implemented.

– Kamping Pouy

If the area irrigated should be restricted, it is allocated according to the elevation of farm plots and the distance from canals. It is converged upstream and the areas irrigated are not shuffled within the irrigation system in every irrigation season. Irrigated areas are converged but equity among water users is not achieved.

**Irrigation period in a climate cycle (see page 15)**

It is ideal to fix approximately a cropping period and an irrigation period so as to help water users to keep to a seasonal irrigation plan.

Water supply is stopped when the planned irrigation period has finished in Nam Houm and Huay Luang project site. This action is performed strictly to make water users follow the irrigation period that has been decided on.

As the irrigation period is almost fixed in Gocong project site, water users understand irrigation plan, which helps them follow the plan.

### **Distributed and concentrated starts of the irrigation period (see 2.2.6)**

All farm plots are recommended to start irrigation simultaneously to reduce the duration of irrigation, whereas sub-systems of the whole canal system should try to distribute their starting dates to reduce peak water requirements for land preparation at the irrigation project level.

If the storage volume of the reservoir is not sufficient, starts to the irrigation period is distributed in Num Houm project site. Crop establishment date for the wet season is distributed in Huay Luang project site to reduce peak water requirements. Farmers start their crop establishment in June, July and August. All farm plots start irrigation simultaneously in Kamping Pouy project site. A peak cut is not created in this project site, because its main canal has enough capacity.

### **Water allocation planning in a reservoir irrigation system (see page 19)**

When a reservoir has a storage capacity that exceeds the demand for a single irrigation season, the present storage can be expected to be used for two or more irrigation seasons. If reservoirs are intended for multiple uses, water storage is allocated to each purpose

A part of the water storage in the reservoirs at the beginning of the dry season is allocated for the next wet season in Nam Houm and Kamping Pouy project site. The water volume of 3 MCM is preserved in Nam Houm. In Kamping pouy, 60% of the water volume in the reservoir is used for the dry season.

### **Water allocation plans for low-lying irrigation systems (see page 20)**

Tidal irrigation systems store water in canal systems for the irrigation of farm plots. Water is controlled by controlling stored stocks instead of flows in these irrigation systems. Target water levels instead of canal flow rates are determined monthly for the wet season in Gocong project site. One is the upper water level (UWL) and another is lower water level (LWL). UWL is the level that avoids inundation damage in the lowest plots and LWL affords water lifting to the

highest plots without, or with the minimum amount of, pumping. The target water levels are not determined for the dry season.

### 3. Irrigation scheduling

#### Outline of irrigation scheduling (see 3.1)

Irrigation scheduling is defined as determining when and where to irrigate and how much water to use for irrigation. Water requirements vary every day, so the water supply should flexibly follow these changes. In this respect, irrigation scheduling is an effort to adjust water supply to meet water demand and to increase irrigation efficiencies while avoiding water deficits in farm plots.

#### – Num Houm

Usually, irrigation scheduling is not carried out for the dry season in Num Houm pilot project site. Irrigation water is supplied at a constant volume as described in the seasonal irrigation plan. Irrigation water supply for the wet season depends on water users' request.

#### – Huay Luang

Irrigation scheduling is implemented every week. The committee is held to determine the water delivery plane every Monday. Water supply is controlled by irrigation scheduling. (Figure 2)

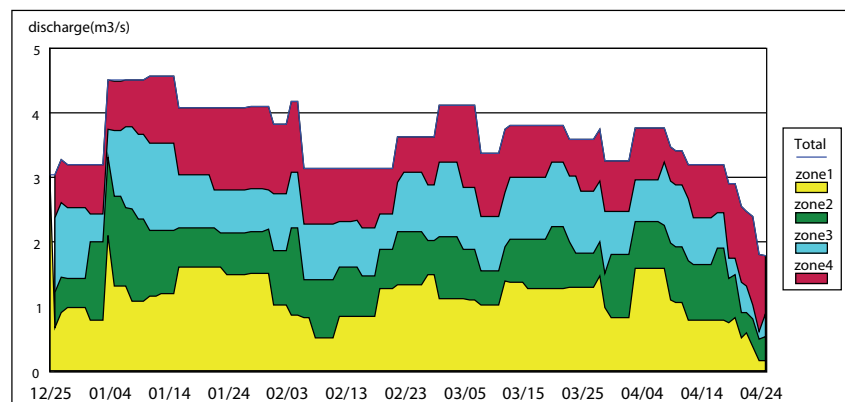

Figure 2 Water supply to each irrigation zone

— Kamping Pouy

Irrigation water is supplied intermittently to the whole system for the dry season and the wet season in Kaming Pouy project site (Figure 3). Although the dates are determined by the seasonal irrigation plan, they are mortified irrigation scheduling.

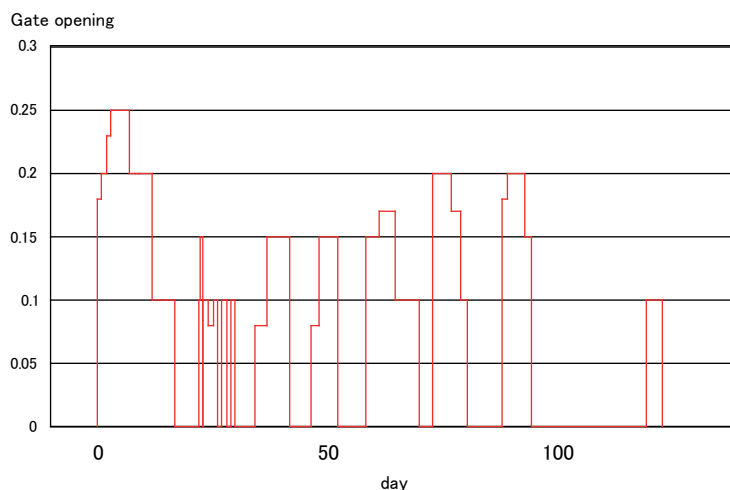

Figure 3 Intake gate opening

— Gocong

Operation plans of gates to improve the stagnant condition of canals are established twice a month in the wet season. Water users are informed of this operation plan through mass-media.

This plan is mainly related to sluices. There are two types of sluices in the project. One is the salinity intrusion protection sluice. The main purpose of this sluice is for drainage and salinity intrusion prevention. The sluice is operated once every two weeks to release water from the project area to the river to avoid the stagnant condition of water. This operation is scheduled. This sluice is also operated to take water from the river when salinity concentration of river flow is low. Another is the internal sluice used as a cross-regulator, which is operated to raise the water level in the project.

**Continuous and intermittent water supply (see page 28)**

There are two methods of controlling water volume in an irrigation system: ‘continuous supply’ and the latter ‘intermittent supply’. In general, continuous water supply is used for the main canal and intermittent water supply is used for tertiary canals.

– Num Houm

Irrigation water is supplied continuously for the dry season. As irrigation water is supplied according to the water users' request for the wet season, it is supplied intermittently for the whole system.

– Huay Luang

Irrigation water is delivered to the main canal and secondary canals continuously. On the other hand rotation irrigation supply among tertiary canals is implemented. Two weeks rotation is planned in this project (Figure 4). Irrigation water is diverted intermittently to a tertiary canal for several days depending on the features of the canal. Water flow with 0.5 m<sup>3</sup>/s is maintained in the main canal to flush garbage, to reduce time and to cope with uplift pressure in canals.

แผนรอบเวรการรับน้ำ ของกลุ่มบริหารสาขานอกเขตพัฒนาภาคตะวันออกเฉียงเหนือและบำรุงรักษาที่ 3 ประจำปีงบประมาณ 2550  
ใบที่ 1 ฝั่งอำนาจและบำรุงรักษาที่ 3 ประจำปีงบประมาณ 2550

ลำดับที่	ชื่อลูกคลอง/กม.	พื้นที่ไร่	สมาชิกไร่	สัปดาห์ที่ 1							สัปดาห์ที่ 2							สัปดาห์ที่ 3											
				1	2	3	4	5	6	7	8	9	10	11	12	13	14	15	16	17	18	19	20	21	22	23	24	25	26
				ส	อ	จ	อ	พ	พฤ	ศ	อ	จ	อ	พ	พฤ	ศ	อ	จ	อ	พ	พฤ	ศ	อ	จ	อ	พ	พฤ	ศ	อ
1	1R LMC 0+567	>350	1																										
2	2R LMC 1+104																												
3	3R LMC 1+470																												
4	4R LMC 1+800	315	22																										
5	5R LMC 2+320	287	22																										
6	6R LMC 2+930	614	36																										
7	7R LMC 3+150	114	11																										
8	8R LMC 3+900	43.50	4																										
9	9R LMC 4+400	313	24																										
10	10R LMC 5+190	86	5																										
11	11R LMC 5+545	23	5																										
12	12R LMC 6+200	55	7																										
13	13R LMC 6+395	86	6																										
14	14R LMC 6+800	580	36																										
15	15R LMC 7+275	103	13																										
16	16R LMC 8+001	299	31																										
17	17L LMC 8+035	152	6																										
18	1R 2R-L 0+030	115.25	19																										
19	2L 2R-L 0+030	48	9																										

Figure 4 Rotation delivery plan

Rotation plan of February 2007. Second column: Name of a tertiary canal. Third column: Irrigation area, Forth column, the number of related water users. The dates in which a tertiary canal receives irrigation water is indicated in solid line.

– Kamping Pouy

Irrigation water is supplied intermittently to the whole system for the dry season and the wet season (Figure 3). Intermittent water delivery in the main canal may contribute to reduce water losses. On the other hand, it may cause cracks in canal. However, the main canal of this irrigation system dose not becomes empty, because weirs keep water in the main canal.

### **Estimation of water demand (see page 32)**

For irrigation scheduling there are three major ways to estimate water demand: field surveys, calculations using meteorological data, and requests from water users.

#### – Num Houm

Water demand is not estimated during the dry season, because irrigation water is supplied at a constant volume which is described by the seasonal irrigation plan. Flexible water supply is not carried out. Irrigation water supply is planned in the nursery stage and is not planned in the growing stage for the wet season. Irrigation water is supplied when the water users with more than 20 ha farm plots request it in the growing stage.

#### – Huay Luang

Field survey, calculations using meteorological data and requests from water users are utilised to estimate water demand in this project site.

The calculation method is, in principle, the same as that used in the formulation of the seasonal irrigation plan. However, present data instead of historical data are used for some elements, such as rainfall. If water requirements increase by more than 30 % as compared to the plan, water supply is increased.

Standing water depths are measured to estimate water demand. Measurements may only cover critical farm plots such as those located far from tertiary canals and those at high elevation. If water depths are less than 8 cm, water supply is increased. If water users request water supply, the field survey is implemented to make sure of water deficit.

When it is heavy rainfall of more than 40 mm, water supply is immediately reduced.

#### – Kamping Pouy

Field survey and requests from water users are utilised to estimate water demand in this project site. Water supply is requested from water users through WUG to FWUC. Irrigation water is supplied by FWUC when more than 50 % of WUGs request water supply. Water flows at the ends of canals or at spill works is watched to quantify the excess water supply to the canal

#### – Gocong

IMC receives water users' requests directly.

---

### **Excess water supply (see page 36)**

Excess water should not be supplied for efficient water management. Irrigation water is supplied as much as required. However, excess water is diverted beyond water demands if it is stored in regulating reservoirs, irrigation canals and farm plots. Excess water supply is implemented in Huay Luang project site.

### **Constraints on water delivery (see 3.3)**

When the volume of available water is less than expected in the seasonal irrigation plan, water delivery is restricted by updating the irrigation scheduling. If the storage volume of the reservoir is less than 20 MCM, irrigation water supply is stopped in Huay Luang project site. Constraints on water delivery are discussed with representatives of IWUG before they are implemented.

### **Outline of canal operations (see page 38 and 39)**

Canal operations imply actions that operate gates or valves at canal structures such as intakes, turnouts, or cross-regulators. Canal operations aim to deliver water as determined in the irrigation scheduling.

There are two water control methods. One is flow rate control and another is water level control. The control method depends on the measurement method. Namely, if flow rate is measured, flow rate control can be employed, and if only the water level is measured then the water level is manipulated. Flow rate control is easier than water level control for appropriate water distribution in a gravity irrigation system.

A flow rate of released water from the reservoir is measured in Num Houm project site. Any flow rate is measured at other points including cross-regulators. Although diversion works to secondary canals are CHO (constant head orifice), they are not used as measuring devices. Flow rates are measured at several points in Huay Luang project site. They are diverted water into the main canal (Left main canal) and water entering another zone in the main canal. Any flow rate not measured before IIEPF field survey was carried out in Kamping Pouy project sites. Water levels at cross-regulators and gates in Gocong project sites.

Mainly the water level control and measurement system is used in Num Houm, Huay Luang and Kamping Pouy project sites. This system has difficulties in terms of canal operations. Gates are operated by several trials by skilled operators for one change of water distribution in Huay Luang. First, the intake gate is operated in Kamping Pouy project site. Next, water level at the end of the main canal is monitored. The intake gate is operated several times until the water level becomes the planned level. In Num Houm project site, gate operations are not so frequent,

because irrigation water is supplied at a constant volume as described in the seasonal irrigation plan.

#### **Operation of cross-regulators ( see page 46)**

There are two types of cross-regulator operations, upstream control and downstream control. Although cross-regulators are installed in Num Houm project site and Huay Luang project site, they are not used to keep water level constant. Cross-regulators can be used as regulating reservoirs. However it is not carried out in any projects sites.

#### **Operation of regulators in low-lying areas (see page 48)**

In low-lying areas, regulator operations are implemented to maintain the target water level in consideration of the mutual effects of gate operation. The salinity intrusion protection sluices are operated one by one in Gocong project site to avoid the mutual effects.

#### **Communication between operators (see page 48)**

Usually, however, two or more operators control the irrigation water in large- or medium-scale irrigation systems. This implies that the responsibility of canal operations is shared among operators. Operators should communicate with each other to reduce spill water volumes, unexpected fluctuations, and water deficits in the main and secondary canals. The main canal is divided into four irrigation management zones in Huay Luang project site. Zone staff communicate with each other.

## **4. Water management of tertiary canals**

#### **Establishment of water users' associations (see 4.1)**

Water users' associations play important roles in reducing excess water intake at the tertiary canal level. Rules are established by the association for performing irrigation scheduling and turnout operations. In Huay Luang project site, farmers out of the project divert irrigation water into their farm plots without right. To reduce vandalism these farmers are organised into WUG. In Kamping Pouy project site, FWUC has one rule for collecting service fee. The service



---

fee differs according to the rice yield. If rice yields are reduced as a result of unfair water distribution, water fee of related water users are reduced.

#### **Prohibition of turnout operation by water users (see 4.2)**

One effective way of maintaining orderly water delivery is to prohibit water users from operating turnouts connected to their own farm plots: only an authorised water manager is allowed to deliver water to each farm plot. The prohibition of turnout operation by water users in the tertiary canals is not carried out in any pilot project site.

#### **Intermittent water delivery to tertiary canals (see 4.3)**

Inequity of water delivery becomes a more serious issue when the water supply is small. Use of an intermittent (on–off) water supply is one method to reduce inequity. Rotated irrigation supply among tertiary canals is effective in reducing water loss and inequity of supply in the tertiary canals, because it prevents excess diversion by upstream water users. In Huay Luang project site, this rotation is implemented. In Kamping Pouy project site, it was attempted before but is abolished now.

#### **Enhancement of plot-to-plot irrigation practices ( see 4.4)**

Occasionally there are conflicts between water users with plot-to-plot irrigation. Mediation by the water manager or WUA leader can resolve these conflicts. This activity is not prevailing but found in parts of pilot project sites.

## **5. Improvement of physical structures**

#### **Installation of regulating reservoirs (see 5.1)**

Regulating reservoirs in a canal system reduces the gap between water demand and water supply; this gap is caused by the time needed for the irrigation water to travel in the system or by delays in information transfer. Regulating reservoirs are not found in any pilot project site. In Huay Luang project, there are public ponds used for domestic water. They have great potential as regulating reservoirs.

### **Installation of cross-regulators (see 5.2)**

The main function of a cross-regulator is to regulate the water level in canals. In Kamping Pouy, cross-regulators are used as weirs by stop logs. Although there is not enough hydraulic head, those function well to maintain the water level of a canal, because of large cross-section of a canal.

### **Improvement of canal systems (see 5.3)**

Uncontrolled flows and direct turnouts make canal operations complicated. One way of solving these problems is to improve the canal system. However, Huai Luang project adopt other measures to reduce water level fluctuations caused by direct turnouts. Direct turnouts are operated by project staff.

### **Construction of tertiary canals (see 5.4)**

Plot-to-plot irrigation systems can be problematic in terms of water distribution. Construction or expansion of tertiary canals can facilitate the water distribution to each farm plot and help solve these difficulties. In Kamping Pouy project sites, FWUC is planning to expand farm ditches.

### **Installation of remote monitoring and control systems( see 5.5)**

Introduction of remote monitoring and control systems reduces irrigation losses through the acceleration of responses to changes in water demand in a project. The systems are not installed in any pilot project sites. However, remote monitoring systems have been introduced in several irrigation projects in Thailand.

### **Installation of automatic gates (see 5.6)**

An automatic gate is very useful for stabilising water flows and achieving effective water management. It is used at cross-regulators, intakes, and turnouts. Automatic gates controlled hydraulically can be seen pilot project sites. They are used mainly as intake gates or cross-regulators. In Gocong, several radial gates are replaced with automatic gates. Another type of automatic gate is controlled by computer, which is not installed in any pilot project sites.

---

### **Facilities for reuse of irrigation water (see 5.7)**

Reuse of irrigation water should be promoted by the installation of appropriate irrigation facilities. In Huay Luang, water users in downstream areas have the chance to reuse the water for irrigation via the first Huay Luang dam.

### **Construction of regulators and canal improvement in low-lying systems (see 5.8)**

It is important to keep water levels at targeted heights over the whole irrigation system. The elevation of farm plots, however, varies even within the same irrigation system. Water level control structures such as cross-regulators have been constructed and are planned in Gocong project site.

Generally speaking, since the canal slope is very flat in low-lying irrigation systems, the flow velocity is very small. Sometimes not enough water can be delivered to the end of the irrigation system. In this case, the canals need to be expanded or structures that act as obstacles to irrigation water flow need to be removed. These works have been carried out in Gocong project site. In the dry season, irrigation water is distributed among the system without controlling it.

## **6 Managerial and technical aspects**

### **Monitoring (see 6.1)**

Real-time monitoring is useful for recognising changes in water demand and supply and responds to such changes immediately. At the same time, monitoring is used to improve future water management. Accumulation of long records is necessary to create more appropriate water management rules. Huai Luang and Gocong projects have long records related to irrigation management. Kamping Pouy project just started monitoring.

### **Water requirement (see 6.2)**

The concept of water requirement estimation is the same as that used for seasonal irrigation planning and irrigation scheduling. Even if the same method is used for irrigation project planning, related factors should use latest values. The values for current irrigation efficiency used for the design stage were examined and revised in Huay Luang project site.

### **Organisation (see 6.3)**

Participatory irrigation management (PIM) was introduced in Lao PDR, Thailand and Cambodia. Water users' association is not established in Gocong project. However, irrigation management transfer (IMT) for sustainable irrigation management is promoted in Viet Nam.

#### Role of maintenance (see 6.4)

Irrigation facilities should be kept in good condition. The roles of parties involved in maintenance need to be described.

Before the irrigation season starts, silt and weeds are removed. Secondary canals and tertiary canals are maintained by IWUG and WUG respectively in Huai Luang project site. Canal maintenance is included in the planning procedure. Before the irrigation season starts, the canal condition is examined. Repair works and canal cleaning are implemented to make sure of appropriate water distribution.

### **Institutional system design (see 6.5)**

Most water management improvements are implemented in each irrigation system by project staff and water users. Some improvements, however, need the help of legislation, which seems to be a very strong and useful tool for solving a wide range of problems in pilot project sites.

Kamping pouy project diverts water from another river system to the reservoirs. It may cause conflicts with water users downstream. Water rights systems are important to resolve conflicts between upstream and downstream water users.

In Gocong project site, water is circulated within a scheme. This practice contributes to high irrigation efficiency, but it causes degradation of water quality and stagnant conditions. Legislation for the conservation of water quality may be effective to solve this problem.

The improvement of plot-to-plot irrigation systems by the construction of tertiary canals is effective in improving irrigation management. Some farmers who lose their farm plots, however, may oppose tertiary canal construction in Kamping Pouy project sites. Substitute lot planning is a legal method of exchanging lots and solves this problem.





Mekong River Commission  
P.O.Box 6101, Vientiane 01000,  
Lao PDR. Telephone: (856) 21 263 263 Facsimile: (856) 21 263 264  
E-mail: [mrcs@mrcmekong.org](mailto:mrcs@mrcmekong.org)  
Website: [www.mrcmekong.org](http://www.mrcmekong.org)