

# BALTIC SEA ENVIRONMENT PROCEEDINGS

No. 80

## INTERCOMPARISON OF SEDIMENT SAMPLING DEVICES USING ARTIFICIAL RADIONUCLIDES IN BALTIC SEA SEDIMENTS

- The MOSSIE Report -



HELSINKI COMMISSION  
Baltic Marine Environment Protection Commission  
2000

HELSINKI COMMISSION  
Baltic Marine Environment Protection Commission

Katajanokanlaituri 6 B, FIN-00160 Helsinki, Finland

Phone +358-(0)9-6220 220, fax +358-(0)9-6220 2239

E-mail: [helcom@helcom.fi](mailto:helcom@helcom.fi)

<http://www.helcom.fi>

ISSN 0357-2994

# BALTIC SEA ENVIRONMENT PROCEEDINGS

No. 80

## INTERCOMPARISON OF SEDIMENT SAMPLING DEVICES USING ARTIFICIAL RADIONUCLIDES IN BALTIC SEA SEDIMENTS - The MOSSIE Report -

HELSINKI COMMISSION  
Baltic Marine Environment Protection Commission  
2000

For bibliographic purposes this document should be cited as:  
HELCOM, 2000  
Intercomparison of Sediment Sampling Devices using Artificial Radionuclides in Baltic Sea Sediments  
- The MOSSIE Report -  
Baltic Sea Environ. Proc. No. 80

Information included in this publication or extracts thereof is free for citing on the condition  
that the complete reference of the publication is given as stated above

Copyright 2000 by the Helsinki Commission  
- Baltic Marine Environment Protection Commission -

ISSN 0357-2994

# **INTERCOMPARISON OF SEDIMENT SAMPLING DEVICES USING ARTIFICIAL RADIONUCLIDES IN BALTIC SEA SEDIMENTS**

**Erkki Ilus<sup>1</sup>, Taina Ilus<sup>1</sup>, Tarja K. Ikäheimonen<sup>1</sup>, Lauri Niemistö<sup>2</sup>, Jürgen Herrmann<sup>3</sup>, Maria Sup-  
linska<sup>4</sup>, Yuri Panteleev<sup>5</sup>, Ludmila Ivanova<sup>5</sup>, Ziegfrid G. Gritchenko<sup>5</sup>, Georg Neumann<sup>6</sup>**

<sup>1</sup> **STUK - Radiation and Nuclear Safety Authority, Helsinki, Finland**

<sup>2</sup> **Maria Jotunin tie 14 B 185, FIN-00400 Helsinki, Finland**

<sup>3</sup> **Federal Maritime and Hydrographic Agency, Hamburg, Germany**

<sup>4</sup> **Central Laboratory for Radiological Protection, Warsaw, Poland**

<sup>5</sup> **V.G. Khlopin Radium Institute, St.Petersburg, Russia**

<sup>6</sup> **Hälsingegatan 8, 3tr, SE-113 23 Stockholm, Sweden**

## CONTENTS

Introduction .....	1
General errors involved in sediment sampling .....	2
Sampling arrangements and analyses .....	5
Description of sampling devices and techniques .....	9
Some notes on sampling on board the Aranda .....	19
Results and discussion .....	20
Depth profiles of radionuclides .....	20
Statistical considerations .....	22
Impact of corer diameter or area .....	24
Characteristics of the sampling devices used in the MOSSIE exercise .....	25
Conclusions .....	26
References .....	29
Figures 6 -19 .....	31
Tables I - VI .....	45
Appendix - Analytical data .....	51
Baltic Sea Environment Proceedings .....	70

## INTRODUCTION

During the last four decades Baltic Sea sediments have been an excellent object for research by radioecologists and other scientists studying sedimentation and other processes in sediments using artificial radionuclides deposited in sediment laminae of the seabed in chronological order. This is due to two major events which have caused significant radioactive fallout in the Baltic Sea region, leaving distinct markers in the corresponding layers of the sediments. One was the global fallout from atmospheric nuclear weapon tests in the late 1950s and early '60s, resulting in clear peaks of long-lived radionuclides such as Cs-137, Sr-90 and certain transuranic elements (especially Pu-239,240) in the sediments. Another was the fallout from the accident at Chernobyl NPP, in the former USSR, in April 1986. Since the first radioactive clouds from Chernobyl travelled north and caused high deposition in the Baltic Sea region, the Baltic was the sea most affected by the accident (Povinec et al., 1996). The main long-lived constituents in this fallout were Cs-137 and Cs-134. These radioactive markers have since been utilised, e.g. in dating sediments and determining the sedimentation rate (e.g. Ilus, 1998).

The sedimentation rate ( $\text{mm a}^{-1}$ ) and sediment accumulation rate ( $\text{g cm}^{-2} \text{a}^{-1}$ ) vary widely in the Baltic Sea, depending on the area and local environmental factors there. The rates may even be different at sampling points situated very near to each other. A study carried out in 1995-1996 showed that the sedimentation rates varied between 0.2 and 29  $\text{mm a}^{-1}$  at different soft-bottom sampling sites in the Baltic Sea, depending on the sedimentation itself and the method used for calculation (Ilus et al., 2000). The corresponding accumulation rates of dry matter ranged from 0.006 to 0.90  $\text{g cm}^{-2} \text{a}^{-1}$ . The importance of undisturbed, high-quality samples is especially pronounced in sedimentation rate studies. The loss of soft surface sediments during sampling can significantly affect the results, at least if the calculations are based on the Cs-137 and Pu-239,240 peaks.

To get proper results, it is essential to obtain reliable samples from sediments. False conclusions are an obvious risk if the studies are based on biased field samples (Blomqvist, 1992). To be more precise, it is unreasonable to perform exacting and expensive analyses if the samples themselves are unreliable or of poor quality. However, sampling of the top, least consolidated sediments is difficult and, in addition to properly designed devices, requires standardised, and precise working methods, as well as experience and competence from the crew, including awareness of sources of error. Sediment sampling is without doubt one of the most exacting sampling tasks in the aquatic environment. The prime reason is that the upper, most recent layers of sediments are usually very soft and susceptible to resuspension, i.e. the interface between water and sediment resembles "a line drawn in water". The fact that the crew normally can not see what is happening when the sampling device penetrates the sediment makes the work even more difficult (Ilus, 1996).

The MORS (Monitoring of Radioactive Substances) Group of HELCOM (Helsinki Commission) handles radioactivity monitoring in the Baltic Sea. All the countries surrounding the Baltic Sea are partners in this co-operation and all results from participating laboratories are reported and stored in a joint database. The MORS monitoring programme includes regulatory sampling and analyses of sediments at permanent stations performed by different partners, and the variety of sampling devices used by different laboratories is great. The Group therefore decided to arrange an intercomparison exercise on sediment sampling methods and devices called "MOSSIE" (MORS Sediment Sampling Intercalibration Exercise) in 1992. The arrangements for the exercise, the devices compared and the results are presented and discussed in this report. In addition to the authors, the following persons took part in the samplings on board the RV *Aranda* and RV *Valdivia*: Mr. Kari Huusela (STUK), Mr. Juhani Rapo and Ms. Maija Nyberg (Finnish Institute of Marine Research), Mr. Valerie Toporkov (V.G. Khlopin Radium Institute), Mr. Lutz Brüggmann (Institut für Ostseeforschung, Warnemünde), Jan Tomczak and Rafal Stojaczek (Institute of Meteorology and Water Management, Poland). Ms. Taina Ilus was responsible for the statistical analysis of the results and the graphs contained in this report.

## GENERAL ERRORS INVOLVED IN SEDIMENT SAMPLING

The principal requirement for a perfect sediment sample is that it must be **undisturbed**. This means that the unconsolidated surface layers should remain undisturbed and unmixed and if conventional coring tubes or vessels are used, the covering water on top of the sediment should be as clear as it is *in situ*. It also means that all the lower layers must be unmixed and at exactly the same depth in the sample as they are *in situ*.

The main errors involved in sediment sampling are (Fig. 1):

- (1) **LOSS OF** soft, watery and unconsolidated **SURFACE SEDIMENTS** as a result of - **SCAVENGING (BLOW-AWAY)** caused by the pressure wave ("shock wave" or "bow wave") built up in front of the descending sampler;
- (2) **MIXING** and **REDISTRIBUTION OF** sampled **SEDIMENT LAYERS** as a result of the pressure wave, resuspension and other external or internal factors;
- (3) **CORE SHORTENING** = the difference between the depth of the corer's penetration into the sediment and the interior length of the core, i.e. the core is compressed;
- (4) **SMEARING** = downflow of particles from the top layers to deeper layers along the core walls during coring and/or slicing;
- (5) **EDGE EFFECT** = loss of material from the margins of the sediment core, which means that the surface area of the core is smaller than the orifice of the corer;
- (6) **BRIMMING** = filling of the sampler up to the brim;
- (7) **TILTING** of the sampling device at the bottom;
- (8) **LOSS OF ENCLOSED MATERIAL** as a result of brimming or tilting;
- (9) **INGRESS OF SEDIMENT FROM THE OUTSIDE** into the sample as a result of brimming, tilting or resuspension.

The most important characteristic of a sampling device is that it must allow an unhindered flow of water through the corer during descent and the penetration into the sediment. Otherwise, the hydraulic shock wave (bow wave) created in front of the orifice may laterally disperse the easily resuspended surface sediments before the corer reaches the sediment surface (Blomqvist, 1992). In all respects, good hydrodynamic design of the corer is of great importance in avoiding the consequences of the shock wave.

Many corers tend to tilt at the bottom when the attachment wire slackens. The taller the sampling device, the greater the risk of tilting; a high centre of gravity further increases the risk. Loss of the enclosed material and ingress of sediment from the outside are not the only consequences of tilting. Inside, tilting may cause accumulation of the surface sediment on one side and a wedge-shaped gap in the sediment on the opposite side between the bulk sediment and the wall of the corer (Blomqvist, 1992). This gap is often filled by material from the surface layer, which causes errors in the slicing as well as a sloping surface in the sample itself.

The risk of core shortening when small-diameter gravity corers are used has been widely discussed (e.g. Blomqvist, 1985). Nevissi et al. (1989) stated that the shortening of sediment cores is an artefact of coring processes and occurs to some extent in almost any coring device. It is related not only to the type of coring device but also the sediment properties and the velocity of corer penetration into the sediment. As the core barrels are inserted into the sediment, friction along the barrel walls causes core shortening (Jahnke and Knight, 1997). Morton and White (1997) reported that core shortening can result from several different processes, including physical compaction, sediment thinning and sediment bypassing during sampling. The amount of core shortening as a function of the corer's penetration depth is affected by core diameter and penetration velocity (Blomqvist, 1992). In general, there is less core shortening in corers with a large diameter and when the penetration is slow. In extremely soft surface sediments with very high water content, core shortening is usually low.



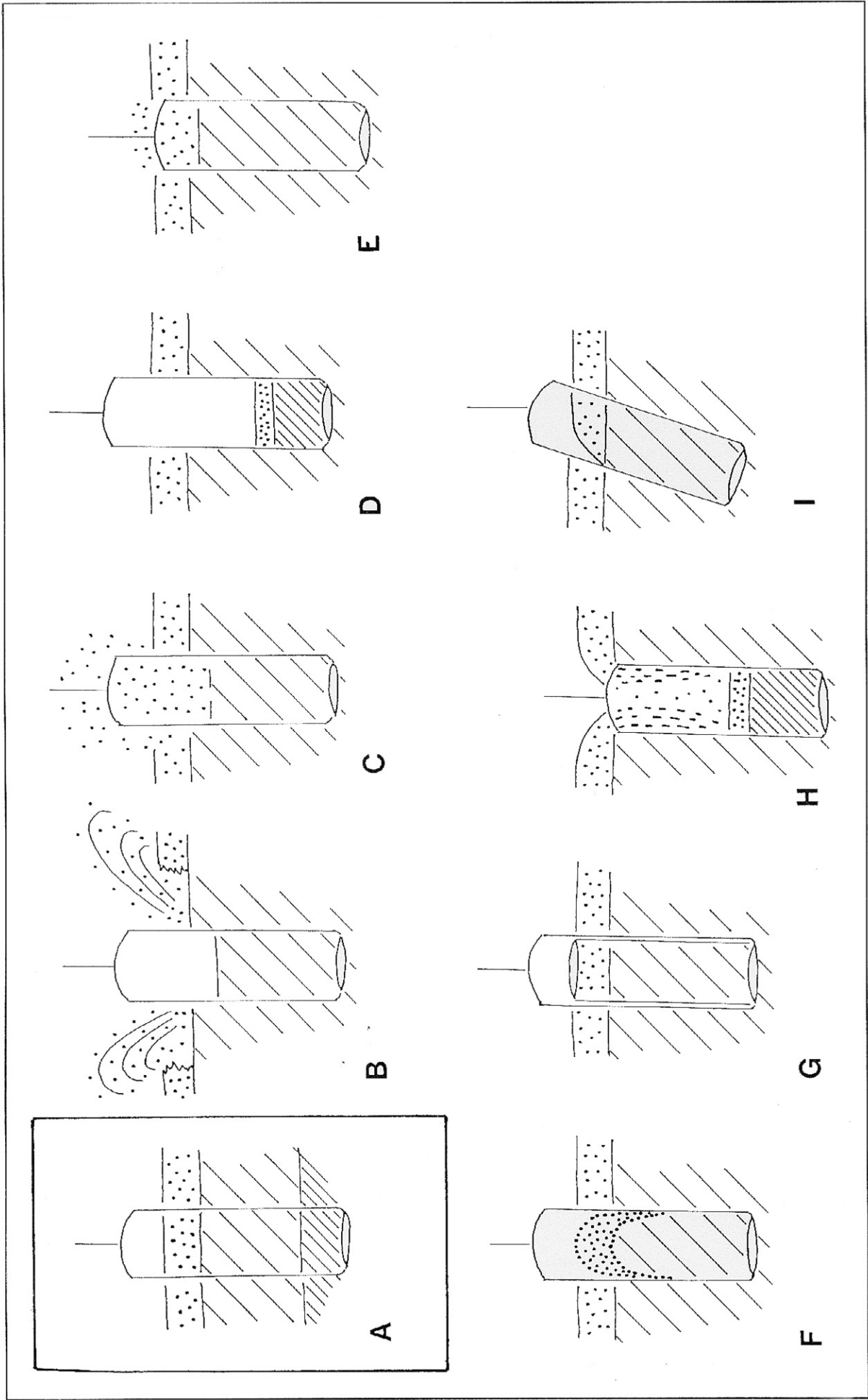

Fig. 1. General sources of error in sediment sampling. A = an undisturbed sample, B = scavenging, C = mixing, D = core shortening, E = brimming, F = smearing, G = plaining, H = "edge effect", I = ingress of material from outside, I = tilting.

Further down, the sediment gradually becomes more compact and the friction against the inner wall of the coring tube increases. When the corer reaches a depth where the ratio between the wall friction and the aperture area of the corer becomes critical, the sediment core begins to act partly as a plough and core shortening begins. Clayey, silty sediments are compressed more than light, unconsolidated, organic sediments, and the beginning of the shortening is related to the corer diameter (Blomqvist, 1992). Exclusionary core shortening typically occurs where relatively stiff, low-porosity sediments overlie a zone of soft sediments and the soft sediments are driven aside as the core barrel containing high-density sediments penetrates deeper (Morton and White, 1997).

If recently contaminated particles in the top layer are dragged downwards along the inner wall of the coring tube and are then found in older, deeper layers than those "*in situ*", the consequences of the smearing effect are particularly disturbing in studies of sedimentation rate based on the vertical distribution of radionuclides. Some intercomparisons have shown that the risk of smearing effect is higher in corers with small diameters (Aarkrog and Dahlgard, 1989, Nies et al., 1990), but the problem might also be related to the consistency of the bottom, the penetration velocity and tilting of the corer.

Problems linked with small-diameter gravity corers in the collection of soft and highly porous sediments have been discussed in many publications. Baxter et al. (1981) reported that small-diameter gravity coring and possibly other techniques using heavy and high-velocity devices in unconsolidated surface sediments can induce extensive loss of material while simultaneously distorting the vertical distribution of sedimentary species of interest. They argued that the extensive sediment loss and mixing process which accompanies gravity coring produces quite feasible, and thus particularly misleading, vertical profiles of chemical parameters, and concluded that a soft-landing hydraulically-damped coring device is more reliable for such work. However, their results were based on experiments in which the corer was allowed to free-fall from a few metres above the sediment surface to the bottom. Evans & Lasenby (1984) showed that the deficiency in coring with gravity corers can be attributed to the high velocity at which the corers fall through the water column and then enter the sediments, resulting in dispersion/blown-away of the surface sediments due to the "shock wave" effect. They tested whether cores taken with a gravity corer making a slow descent into the sediments would give chemical profiles similar to those taken carefully by Scuba divers, and found that there is no evidence to reject the hypothesis that in soft, recent sediments, "slow impact" gravity cores are comparable to diver cores.

To obtain reliable samples, gentle, slow entry and penetration of the coring tube/box into the sediment are essential in order to prevent loss of the flocculent surface sediments. It is clear that the uppermost soft sediments are often seriously disturbed or entirely lost when a free-falling corer is used (Blomqvist, 1992).

Favourable weather conditions and maximum ship stability are naturally advantageous in obtaining undisturbed and reliable samples. If sampling is performed in a small vessel in shallow waters, anchoring is always recommended before sampling. The attachment wire should be lowered as vertically as possible, because bias from the vertical results in tilting of the corer. Supplying the corer with a supporting frame may reduce tilting in difficult circumstances.

Repenetration of the corer into the sediment may easily lead to misinterpretations. Rolling and pitching of the vessel may cause a problem when the sampler hits the bottom, resulting in disturbance before the corer actually enters the sediment (Blomqvist, 1992).

The sample may also be disturbed during the corer closing operation or its withdrawal from the sediment, and during retrieval (Blomqvist, 1992). These stages may, therefore, also require careful, gentle work. Rotation of a corer during retrieval causes shear stress on the sediment. Since the rate of motion increases with the sample area, large-area instruments tend to produce more disturbance (Blomqvist, 1992). To avoid rotation, a swivel should always be connected to the wire.

## SAMPLING ARRANGEMENTS AND ANALYSES

In 1992 the HELCOM/MORS Group arranged an intercomparison exercise called "MOSSIE" on sediment sampling devices and methods. The exercise involved experts and sampling devices from five Baltic Sea countries and was carried out using two research vessels: the *Valdivia* from Germany and the *Aranda* from Finland. Research groups from Germany and Poland were present on board the *Valdivia*, while groups from Russia, Sweden and Finland were on board the *Aranda* (Figs 2-4) .

The arrangement for the MOSSIE exercise was that the *Valdivia* and *Aranda* should meet simultaneously at four sampling stations and the samples should be taken in parallel as close to each other as possible. However, even before she reached the first sampling station the *Valdivia* experienced a technical fault, and the repair caused a delay of three and a half days in its cruise schedule. This incident prevented three of the planned meetings with the *Aranda* at sea and the only station with both ships working simultaneously was station XV-1 in the eastern Gulf of Finland. The *Aranda* complied with the original cruise schedule and the *Valdivia* visited the three other stations a few days later, using exactly the same co-ordinates as the *Aranda* had done. Before establishing the final co-ordinates, echo sounding at 12 kHz was used on the *Aranda* to confirm the sediment quality.

The exercise was carried out at the four sampling stations in different subareas of the Baltic Sea (Fig. 5). The stations represent different types of sediment characteristics of the Baltic. The co-ordinates and depths of the stations are listed below:

Code	Lat.	Lon.	Depth [m]	Date [ <i>Aranda</i> ]	Date [ <i>Valdivia</i> ]
BY-15	57°18.96' N	20°01.99' E	237	02 July 1992	06 July 1992
Teili-1	59°25.77' N	21°29.39' E	160	05 July 1992	09 July 1992
XV-1	60°14.99' N	27°14.73' E	62	08 July 1992	08 July 1992
EB-1	61°03.35' N	19°43.14' E	135	04 July 1992	10 July 1992

The deepest station, BY-15 in the Gotland Deep, represents the watery, anoxic sediment typical of the deep area of the central Baltic Proper, containing rather small amounts of Chernobyl-derived radionuclides. A brownish fluffy layer of organic detritus material 15-20 mm thick, (decomposed organic matter, remains of the copepod *Bosmina* and diatom shells, as identified by microscopy on board) was observed covering the gelatinous laminated sediment package typical of the central Gotland Basin.

Anoxic conditions are also characteristic of the station Teili-1 in the Northern Baltic Proper, where the contamination caused by the Chernobyl fallout is somewhat higher than in the Gotland Deep.

Station EB-1 represents an oxic and relatively compact clay-mud bottom, typical of the central Bothnian Sea, and contains far higher amounts of radionuclides originating from the Chernobyl fallout than the previous two.



Fig. 2. R/V ARANDA at station XV-1.



Fig. 3. R/V VALDIVIA at station XV-1.

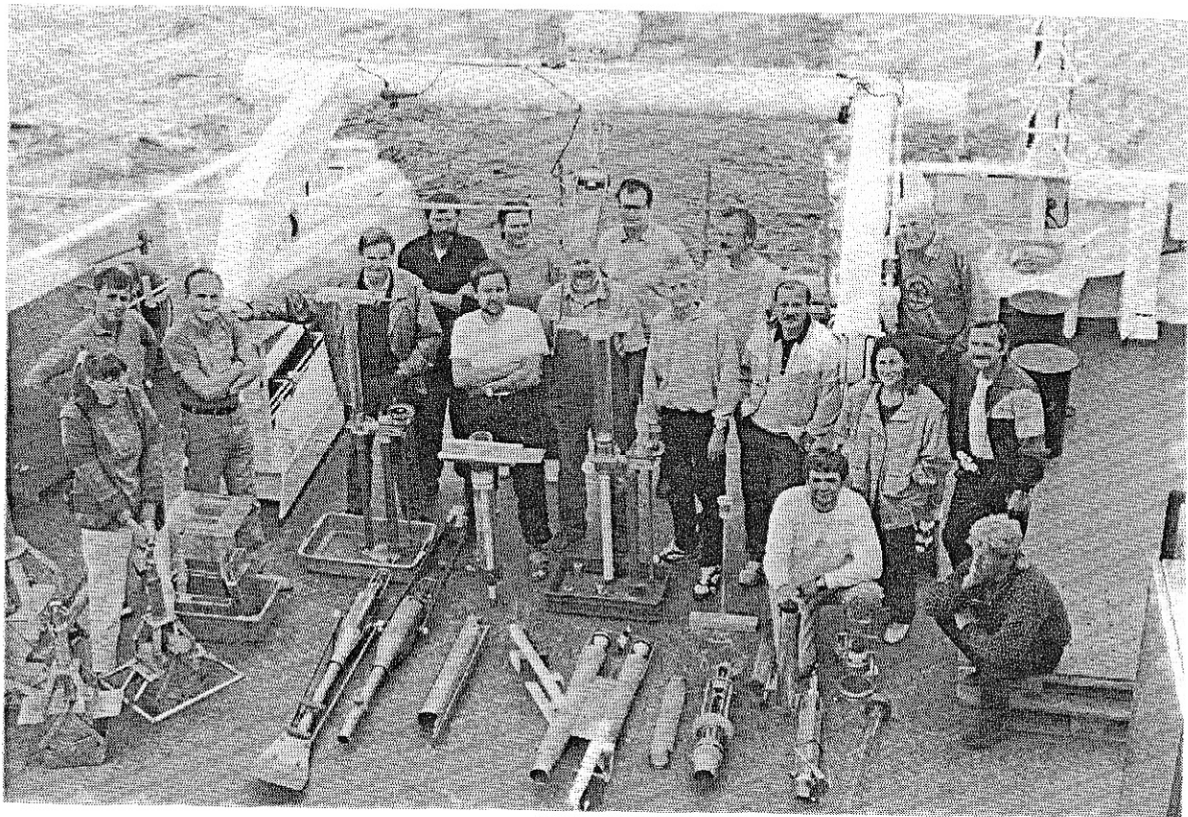

MOSSIE 1992 expedition onboard R/V ARANDA

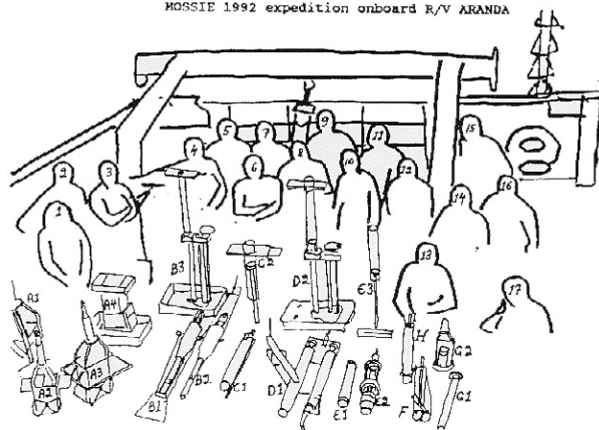

Participants

- 1 Terja Ikäheimonen
- 2 Jan-Erik Bruun
- 3 Boris Winterhalter
- 4 Georg Neumann
- 5 Hannu Hahti
- 6 Juhani Rapo
- 7 Maija Nyberg
- 8 Lauri Niemistö
- 9 Peter Ennet
- 10 Janne Perttälä
- 11 Matti Perttälä
- 12 Yuri Panteleev
- 13 Erkki Ilus
- 14 Natalia Ignatieva
- 15 Rein Tamsalu
- 16 Valeric Toporkov
- 17 Kari Huusela

Sediment samplers used during the MOSSIE 92 Cruise onboard R/V ARANDA

- A1 Box corer (30 x 30 cm)
- A2 Box corer FIMR (20 x 20 cm)
- A3 Box corer STUK/AQUARIUS
- A4 Extruding apparatus for A2 and A3
- B1 Niemistö corer (as closed after sampling)
- B2 Niemistö corer (as open on its way down)
- B3 Extruding piston device for B1 and B2
- C1 Selena corer
- C2 Extruding piston for C1
- D1 GEMINI Twin corer
- D2 Extruding device for D1
- E1 Radium Institute (RI) coreliner
- E2 RI corer
- E3 Extruding piston for E1
- F LIMNOS corer
- G1 Kajak coreliner
- G2 Kajak valve construction
- H STUK corer

Fig. 4. The MOSSIE 1992 research group and the sediment samplers on board the ARANDA.

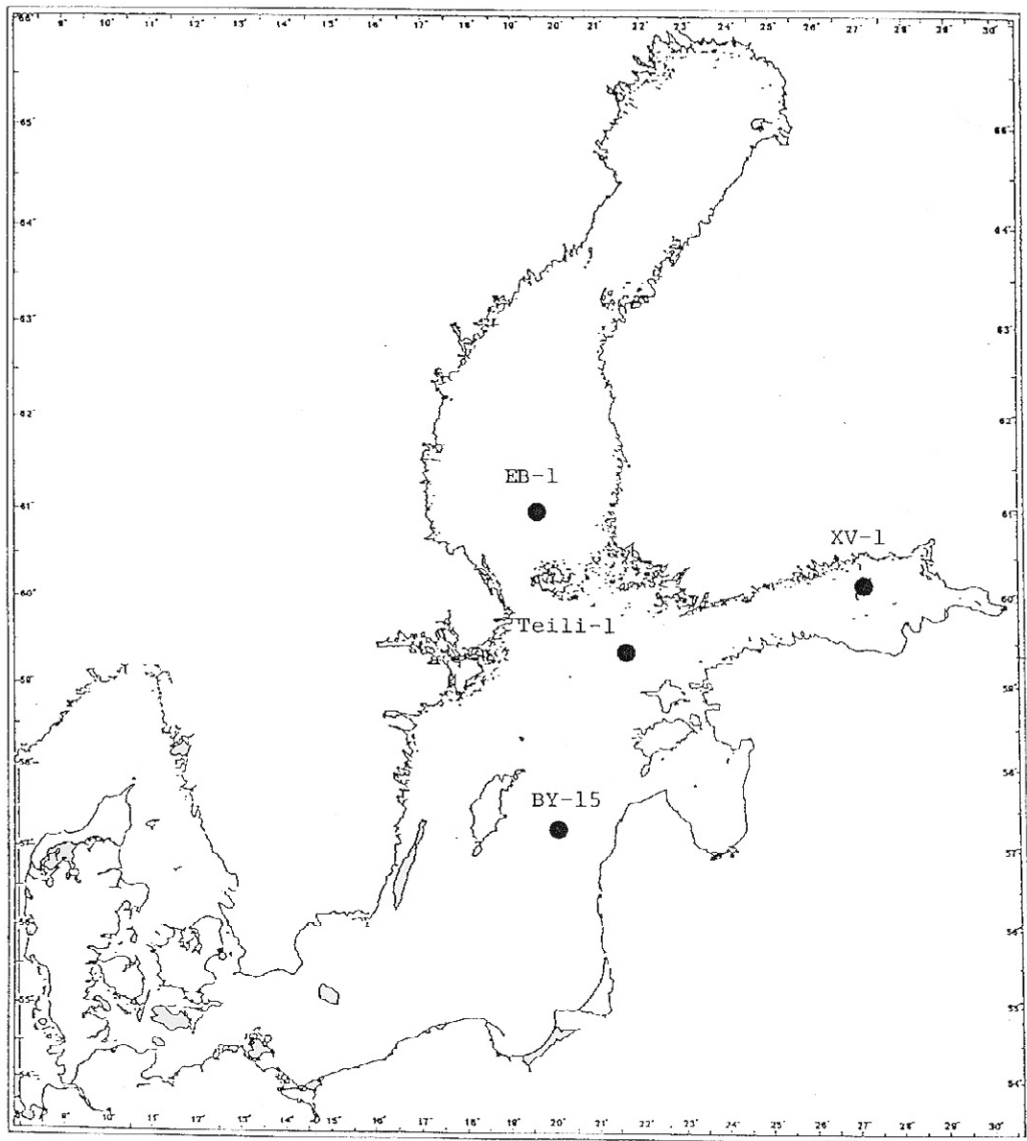

Fig. 5. Location of the sampling stations.

Station XV-1 is situated in the eastern Gulf of Finland and represents an area where the amount of fallout nuclides in sediments is higher than at any of the other stations already mentioned. Anoxic conditions frequently occur in this basin too, where the sediment is very watery and consists mainly of black sulphidic mud.

The samples were sectioned into 1, 2 or 5 cm thick slices on board immediately after the sampling using the particular sectioning equipment and technique varying according to the device (see below). If more than one slice was needed for analysis, parallel sections from an appropriate number of core tubes or barrels were combined and placed in plastic boxes or bags, which were then (without delay) stored in freezer boxes on board. Before analysis the samples were freeze-dried and homogenised.

All the sediment slices were analysed for gamma-emitting radionuclides and some of them also for Pu-238, Pu-239,240 and Am-241. Each laboratory analysed its own samples using its own standard methods. The quality of analysis at each laboratory is currently controlled in intercalibration exercises arranged by the Marine Environment Laboratory (MEL) of the International Atomic Energy Agency (IAEA), Monaco (Ballestra et al., 1995).

## DESCRIPTION OF SAMPLING DEVICES AND TECHNIQUES

Sampling device: **AQUARIUS Box Corer** (STUK)

Type of corer: a frame-supported box corer with an inner coring "aquarium" made of Plexiglas

Total height: 85 cm

Total weight: 26 kg + additional weights 12.5 kg

Closing mechanism: closing jaws and a cutting bottom-plate, which is inserted on the deck before removing the "aquarium" from the corer

Height of the "aquarium": 30 cm

Inner square cross-section of the "aquarium": 182 x 183 mm

Sampled area: 333.1 cm<sup>2</sup>

Number of parallel samples/analysis: 1

Sectioning device: modified from that of the Niemistö Corer, consisting of a plastic square piston, a Plexiglas slicer base and slice holders with thin sliding cover-plates used to section the sub-samples

Sectioning intervals: 2 or 5 cm

Described in: Klemola et al., 1991.

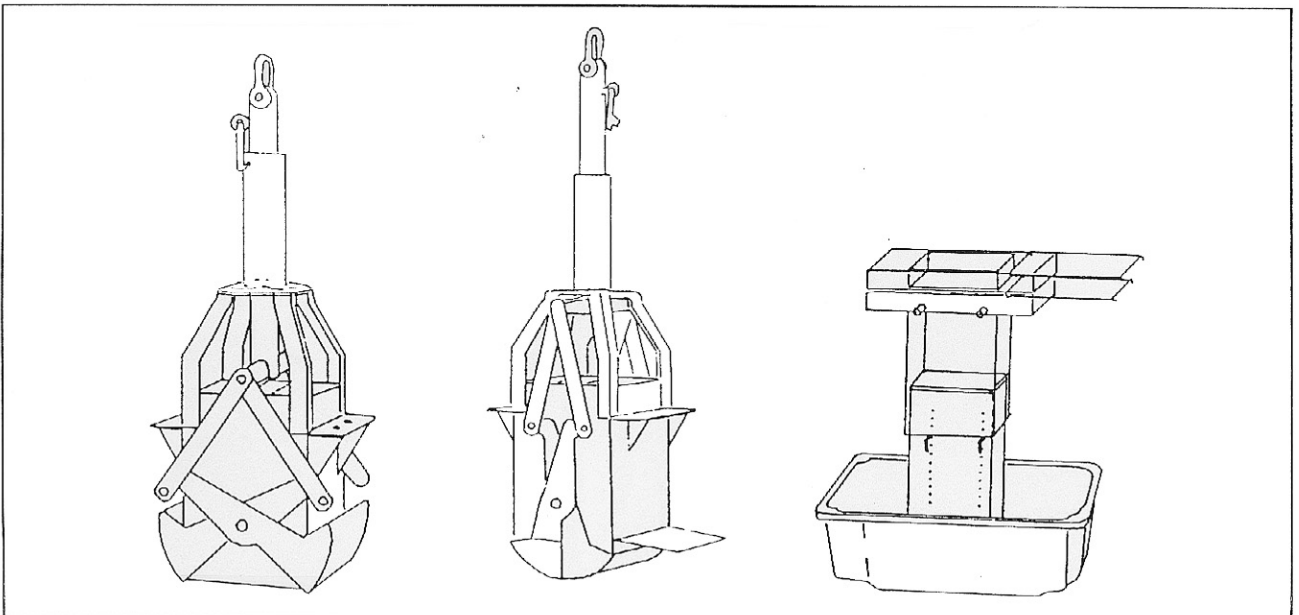
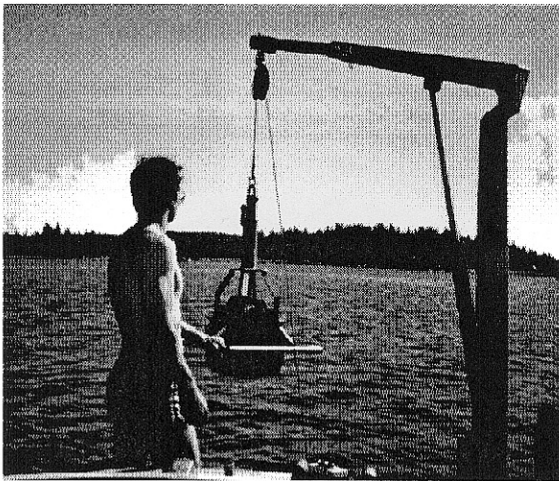

Sampling device: **GEMINI Twin Corer** (FIMR; used by Finland and Russia)

Type of corer: a gravity corer with 2 parallel Plexiglas coring tubes

Total length: 132 cm

Total weight: 33 kg + additional weights, max. 32 kg

Closing mechanism: 2 lateral rudder closers

Tube length: 79 cm

Inner diameter of tubes: 2 x 80 mm

Sampled area: 100.5 cm<sup>2</sup>

Number of parallel samples/analysis: 1 or 2

Sectioning device: identical with that of the Niemistö Corer but with a larger diameter. It consists of a screw-operated extruder-piston, a Plexiglas slicer base and a Plexiglas slicing ring with centimetre scaling

Sectioning intervals: 1 or 2 or 5 cm

A second version of Gemini, Gemax, is described in: Winterhalter, 1998.

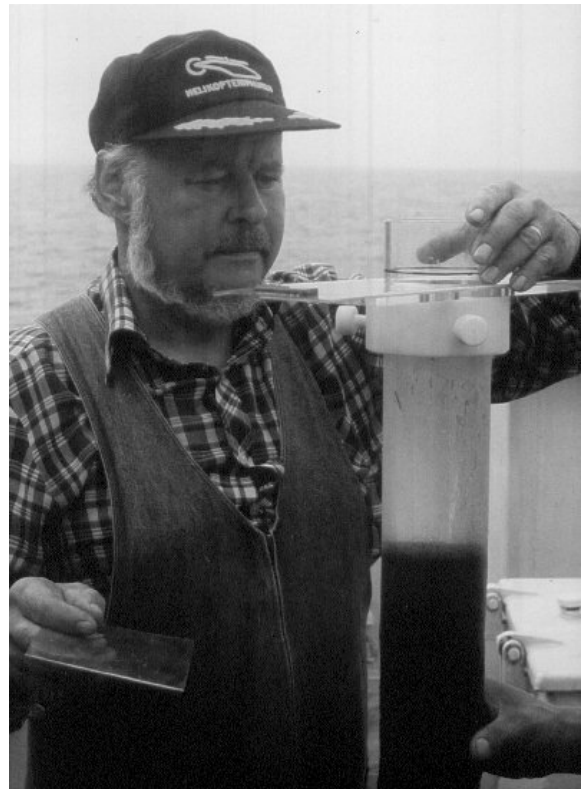
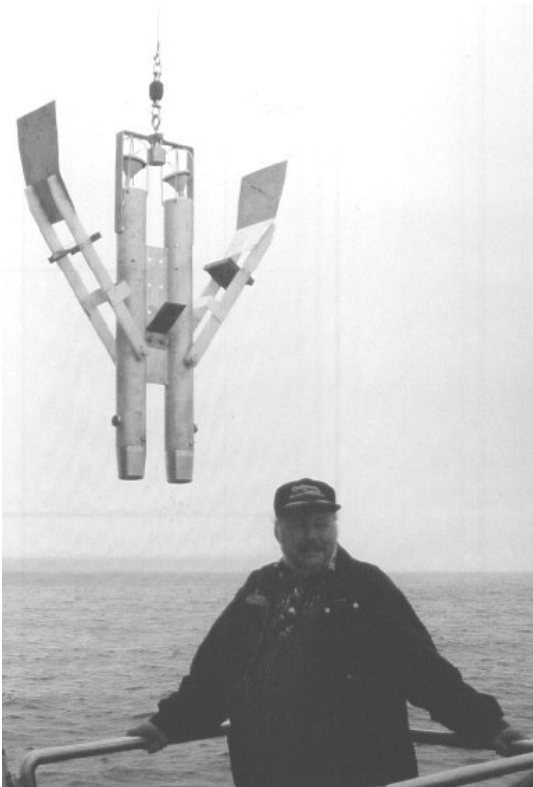



Sampling device: **Large Box Corer** (BSH)

Type of corer: a frame-supported large box corer with portable inner 3mm stainless steel box

Total height: 255 cm (diameter of the supporting frame: 235 cm)

Total weight: 800 kg

Closing mechanism: lateral bottom closer

Height of the box: 50 cm

Inner measures of the box: 500 x 500 mm

Total area of one haul: 2500 cm<sup>2</sup>

Number and inner diameter of the subsample tubes: 2 x  $\varnothing$  94 mm acrylic glass tubes

Area of subsamples: 138.8 cm<sup>2</sup>

Number of parallel hauls/analysis: 1

Sectioning device: consists of a plastic piston with centimetre scaling and a slicing unit with 1 or 2 cm aluminium rings, which are used to cut and remove sediment slices

Sectioning intervals: 2 cm

Described in: not published.



Sampling device: **LIMNOS Sediment Sampler (STUK)**

Type of corer: a gravity corer with a series of plastic rings placed on top of one another

Total length: 94 cm

Total weight: 4 kg + 2 to 6 lead weights, 1.7 kg each (= max. 4 + 10 kg)

Closing mechanism: lateral bottom closer

Tube length: 66.5 cm

Inner diameter: 93 mm

Sampled area: 67.9 cm<sup>2</sup>

Number of parallel samples/analysis: 1 or 2

Sectioning device: slicing is performed by rotating the rings around their one axle so that it cuts a sediment layer of a similar thickness

Sectioning intervals: 1 or 2 or 5 cm

Described in: <http://www.limnos.fi>

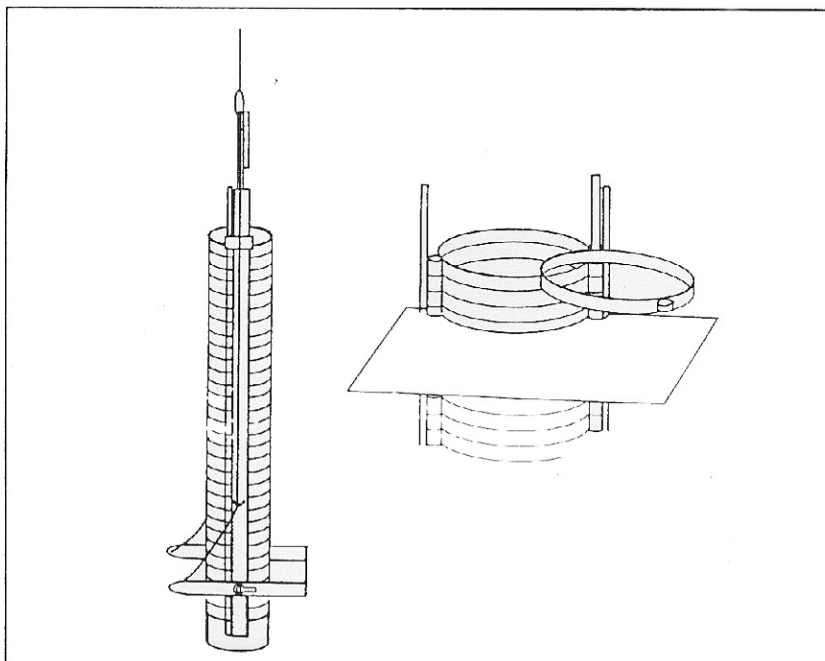
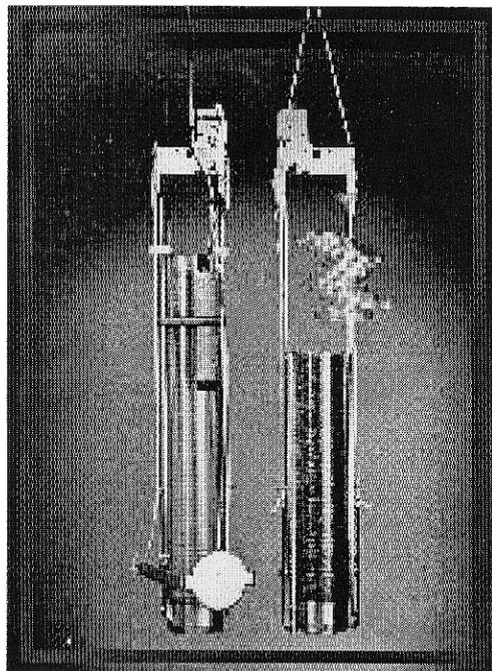

Sampling device: **NIEMISTÖ Corer** (STUK; used by Finland and Sweden)

Type of corer: a gravity corer with an inner Plexiglas coring tube

Total length: 140 cm

Total weight: 13 kg + additional weights, max. 28 kg

Closing mechanism: lateral rudder closer

Tube length: 88 cm

Inner diameter of coring tube: 50 mm

Sampled area: 19.6 cm<sup>2</sup>

Number of parallel samples/analysis: 5 or 10

Sectioning device: sectioning apparatus with a screw-operated core-extrusion piston, a Plexiglas slicer base and slice holders with thin cover-plates for subsamples of varying thickness (0.5-5 cm)

Sectioning intervals: 1 or 2 or 5 cm

Described in: Niemistö, 1974.



Sampling device: **NIEMISTÖ Corer** (Germany)

Type of corer: a gravity corer with an inner Plexiglas coring tube (copy of the original Niemistö corer with a larger tube diameter)

Total length: 140 cm

Total weight: 13 kg + additional weights 32 kg

Closing mechanism: lateral rudder closer

Tube length: 88 cm

Inner diameter of coring tube: 54 mm

Sampled area: 22.9 cm<sup>2</sup>

Number of parallel samples/analysis: 3 (BY-15) or 4 (others)

Sectioning device: see Niemistö Corer above

Sectioning intervals: 2 cm

Described in: Nies et al., 1990, p. 40 (IFM Sampler).



Sampling device: **SELENA Corer (FIMR)**

Type of corer: a gravity corer with an inner Plexiglas coring tube (maxi version of the STUK Corer)

Total length: 79 cm

Total weight: 25 kg

Closing mechanism: spring operated bottom valve released by a messenger weight

Tube length: 70 cm

Inner diameter: 100 mm

Sampled area:  $78.5 \text{ cm}^2$

Number of parallel samples/analysis: 2

Sectioning device: an extruder piston, a plastic slicer base and a Plexiglas slicing ring with centimetre scaling

Sectioning intervals: 2 or 5 cm

Described in: not published.



Sampling device: **Small Box Corer (BSH)**

Type of corer: a frame-supported box corer with an inner 1.5mm stainless steel box

Total height: 160 cm (supporting frame: 110 x 75 cm)

Total weight: 20 kg to 80 kg (with lead weights)

Closing mechanism: lateral bottom closer

Height of the box: 20 cm

Inner measurements of the box: 150 x 150 cm

Total area of one haul: 225 cm<sup>2</sup>

Number and inner diameter of the subsample tubes: 1 x  $\varnothing$  94 mm acrylic glass tube

Area of subsamples: 69.4 cm<sup>2</sup>

Number of parallel hauls/analysis: 2

Sectioning device/method: the same as in the large box corer

Sectioning intervals: 2 cm

Described in: not published.

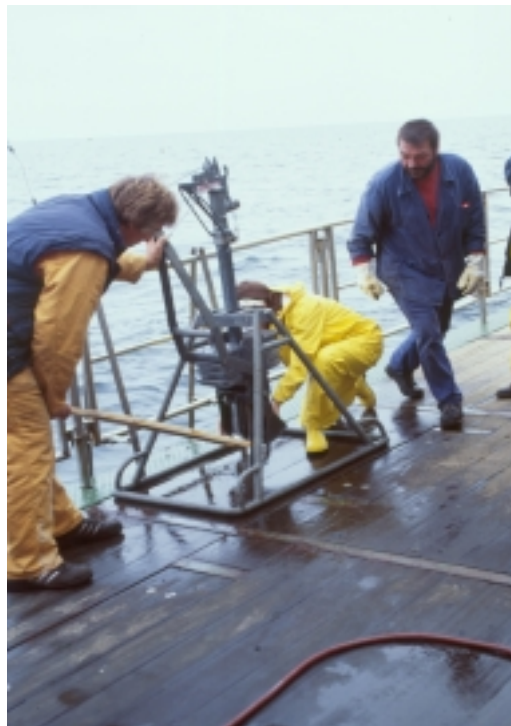

Sampling device: **SPRUT Corer** (CLOR and KRIL; used by Poland and Russia, referred to in text as SPRUT POL and SPRUT RUS)

Type of corer: a gravity corer with an inner Plexiglas coring tube

Total height: 88 cm

Total weight: 20 kg + additional weights 10 kg (8 x 1.25 kg)

Closing mechanism: bottom closed by 12 extruding, flexible, wedge-shaped brass plates

Tube length: 59 cm

Inner diameter of coring tube: 86 mm

Sampled area: 58.1 cm<sup>2</sup>

Number of parallel samples/analysis: 1 (RUS) or 2 (POL in general)

Sectioning device: RUS: identical with that of the STUK Corer but with a larger diameter,

POL: an extruder piston, slicing plate and ring

Sectioning intervals: 2 or 5 cm

Described in: not published.

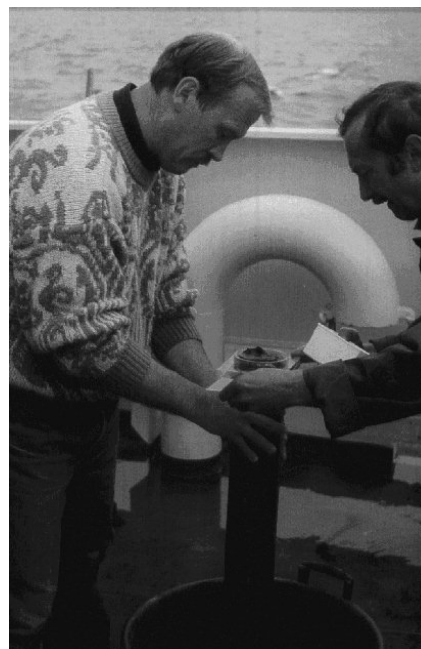

Sampling device: **STUK Corer**

Type of corer: a gravity corer with a thick stainless-steel body and an inner Plexiglas coring tube

Total length: 55 cm

Total weight: 12.5 kg

Closing mechanism: spring-operated bottom valve released by a messenger weight

Tube length: 50 cm

Inner diameter of coring tube: 64 mm

Sampled area: 32.2 cm<sup>2</sup>

Number of parallel samples/analysis: 3

Sectioning device: an extruder piston and simple Plexiglas slicing units with sliding cutting plates

Sectioning intervals: 2 or 5 cm

Described in: Klemola et al., 1991.

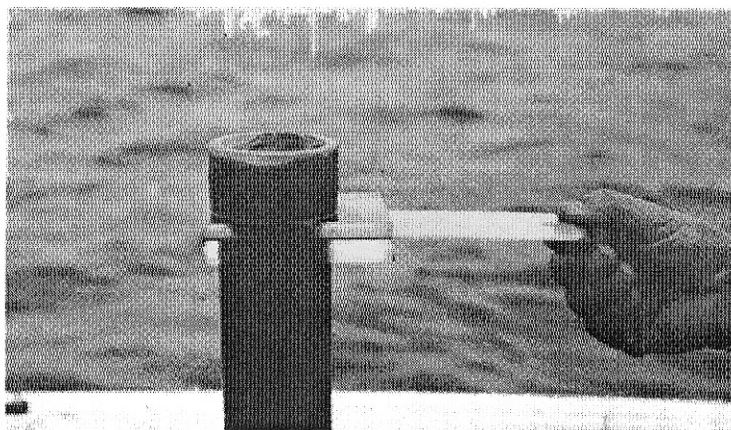
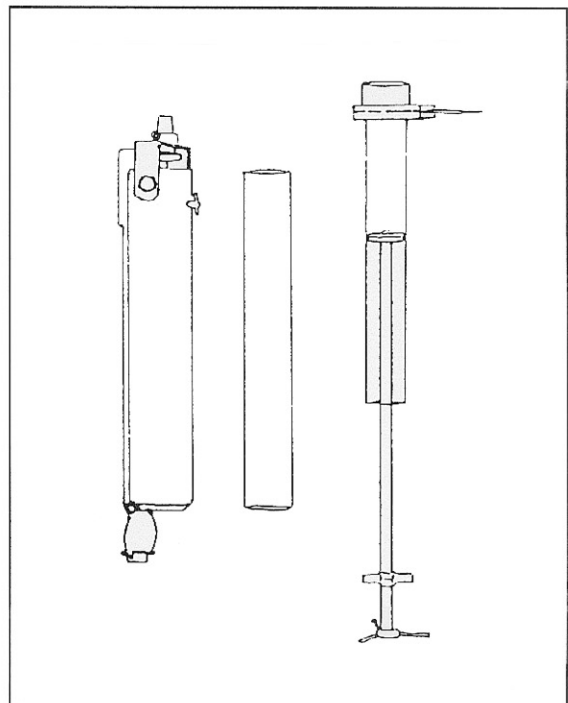
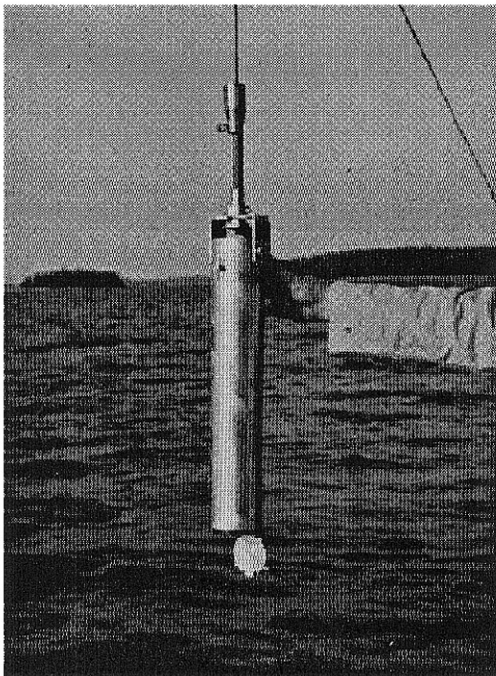



## SOME NOTES ON SAMPLING ON BOARD THE ARANDA

Notes of this kind were available only from the *Aranda*. The sampling programme usually took one day at each station. The weather conditions were quite favourable for sampling. At stations BY-15 and Teili-1 the wind speed was about  $10 \text{ m s}^{-1}$  and the swell was moderate. At station EB-1 the wind speed (about  $12 \text{ m s}^{-1}$ ) and the waves were slightly higher. The ship was kept firmly in place the whole day, but the waves might have influenced the sampling somewhat. At station XV-1 the wind was light and the waves were low.

There were some clear differences in the sampling procedures. The Sprut Corer was allowed to fall at a relatively high speed into the sediment, while the others (especially Aquarius, Gemini and STUK) were lowered very slowly and carefully when the corer was approaching the bottom. Secondly, in all the samples other than those taken by the Sprut Corer, a wash bottle filled with local sea water was used to rinse the sediment remains into the sample boxes from the slice holders or slicing rings. The purpose was to obtain total dry weight and radionuclide values for the unit of area.

At each station the Aquarius Corer was operated without additional weights, but even so it was almost filled up to the brim at station XV-1, where the sediment was extreme soft. From the two samples taken with the Aquarius Corer at stations Teili-1 and XV-1, the second ones looked better visually (see Tables in Appendix). Nevertheless, all the samples taken by the Aquarius Corer during this survey were of excellent quality. The sediment surface was undisturbed, straight and horizontal, without any sign of scavenging, smearing or tilting. The overlying water was clear and full of small benthic animals, such as *Monoporeia affinis*, *Mysis relicta* and *Harmothoë sarsi* at stations EB-1 and Teili-1.

The Gemini Corer was operated without additional weights, too. It was only used at stations BY-15 and Teili-1, but all the samples looked fine, with minimal signs of smearing. The Niemistö Corer was chosen in advance as a reference corer in this exercise, so it was the most frequently used device. It was always operated with 3 additional weights (adding 10.5 kg). In general the samples looked fine, with an even surface and clear overlying water, but quite frequently the edges of the core seemed to be slightly detached from the wall of the coring tube, and clear signs of smearing could be seen. The quality of the Swedish and Finnish samples taken by the Niemistö Corer was generally of the same standard. However, the Swedish samples were sliced with a slicing ring (ref. Gemini Corer) and the Finnish samples with slice holders. Both teams used wash bottles and local sea water to rinse the slicing tools.

The samples taken by the Sprut Corer appeared to be mixed immediately after sampling. The water on the top of the sediment core was black due to disturbance of the surface sediments. However, the coring tubes were allowed to stand for several hours (or overnight). The overlying water was then decanted and filtered before slicing. The aim was to analyse the filters and to add these amounts to the surface sediment results.

The Selena and STUK Corers were tested only at station EB-1 and the Limnos sampler at station XV-1. The cores taken by the STUK Corer looked excellent and also those taken by the Selena Corer and Limnos Sampler were of good quality and fulfilled our quality requirements. Nevertheless, there were minor difficulties in slicing of the first Limnos sample due to the very loose surface sediments.

## RESULTS AND DISCUSSION

Bottom sediments play an important role in aquatic ecosystems, because they usually act as a final sink for organic material produced in the water phase, as well as for other particles transported by water currents from adjacent sea areas or other water courses and from adjacent terrestrial areas. As they slowly sink, the particles tend to bind foreign substances from the water phase and sweep them to the bottom (e.g. radionuclides and other contaminants).

In favourable sedimentation conditions, suspended particles form undisturbed laminae in chronological order, and bottom sediments create an archive from which the historical features of a lake or sea area can be read. Various particle-bound substances can be used as markers of certain historical events or periods. With the aid of these markers the laminae can be dated. Consequently, the amounts of Chernobyl-derived radionuclides, for example, in sediments and their depth distribution in different sediment layers provide an excellent opportunity to study any errors caused by different sampling equipment or techniques. The concentration peaks of certain transuranic elements (e.g. Pu-238 and Pu-239,240) caused by weapons test fallout in the 1950s and '60s also provide useful markers in sedimentological studies.

The analysis results for different slices of the sediment cores taken during the MOSSIE exercise are given in the Appendix. The vertical profiles of Cs-137 and Cs-134 and the total amounts of Cs-137 in the entire cores are shown in Figs 6-13. Normally the samples were analysed at the laboratory that took the samples. However, two cores taken by the Finnish Gemini Twin Corer were analysed by the Khlopin Radium Institute, Russia (stations Teili-1 and XV-1).

In connection with the sampling exercise the IAEA-MEL, Monaco, arranged an intercalibration exercise on radionuclide analyses based on 3 sediment samples taken from the Baltic Sea (IAEA-300, -378, -379). The samples were provided by BSH, Germany (IAEA-300 from the Bothnian Sea and IAEA-378 from the Gotland Deep) and the Polish Institute of Oceanology, Sopot (IAEA-379 from the Gulf of Gdansk). The results have been published (Ballestra et al., 1994) and generally showed very good comparability between the MORS laboratories.

### *Depth profiles of radionuclides*

#### Station BY-15

At station BY-15 (237 m) in the Gotland Deep, the type of sediment is very soft and the water content in the surface layers of the sediment is very high. Thus, there is a significant risk that the surface layers will be disturbed, mixed or even blown away during sampling. The relatively low concentrations of Cs-137 were generally restricted to the uppermost layers of the sediment (Fig. 6).

The lowest dry weight values (0.03-0.04 g cm<sup>-3</sup>) in the surface layer (0-2 cm) were sampled with the Niemistö G (=German), Gemini and Niemistö A (=Aranda) corers and the highest (0.21-0.25 g cm<sup>-3</sup>) with the Small Box Corer and Large Box Corer. The highest Cs-137 peak (207 Bq kg<sup>-1</sup> dry wt.) was also obtained with the Niemistö G, but the highest total value in the whole profile (630 Bq m<sup>-2</sup>) was obtained with the Aquarius. At this station quite comparable Cs-137 results were obtained with the Niemistö G, Aquarius, Gemini, Sprut and Niemistö A. In some of the cores, relatively high concentrations of Cs-134 were detected from below the uppermost 0-2 centimetres (Fig. 7), which might indicate appearance of the smearing effect. Plutonium was not analysed at this station.

### Station Teili-1

At station Teili-1 (160 m) in the Northern Baltic Proper, the sediment type is also anoxic sulphidic mud, which is almost as soft as the sediments in the Gotland Deep. The peak concentrations and the total amounts of Cs-137 in the whole sediment profile are, however, far higher than at BY-15.

The dry weight values of the surface sediment layer obtained with different corers were quite close to each other, ranging from 0.09 to 0.15 g cm<sup>-3</sup>. The lowest dry weights were sampled with the Niemistö A, Niemistö G and Sprut POL and the highest with the Gemini RUS. The highest Cs-137 peak (545 Bq kg<sup>-1</sup> dry wt.) was obtained from the uppermost 0-2cm layer with the Sprut POL, as well as the highest total amount in the whole sediment profile (4940 Bq m<sup>-2</sup>). However, the cores taken by the Gemini and Niemistö A, and sectioned into 1-cm slices, show that the Chernobyl peak occurred in 1992 in the 1-2 cm layer (Fig. 8). At this station the Cs-137 profiles obtained with the Niemistö A, Gemini and Sprut RUS were quite similar and the parallel cores taken with the Aquarius were almost identical. Likewise, the two profiles obtained with the Sprut POL and that obtained with the Niemistö G were similar. In the last-mentioned cores, significant amounts of Cs-137 were found in the layers below 10 cm unlike the other cores. It is possible, that there was a small difference in the sampling positions of the *Aranda* and *Valdivia* and at this station it may significantly influence the results because of the varying bottom topography.

In a majority of the cores, Cs-134 was detected only in the uppermost 4-6 cm, but in some cores it was visible down to 20 cm, which may be due to the smearing effect (Fig. 9). Only one Gemini core was analysed for Pu-239,240 and in this core the Pu peak (9.4 Bq kg<sup>-1</sup> dry wt.) originating from weapons test fallout occurred in the 6-7 cm sediment layer.

### Station XV-1

At station XV-1 (62 m) in the eastern Gulf of Finland, the type of sediment is very loose organic and anoxic sulphidic mud and it is therefore often difficult to obtain undisturbed sediment samples from this station. The highest peak concentrations of Chernobyl-derived Cs-137 were detected at this station, although the highest total amounts in the whole sediment profile occurred at station EB-1 in the Bothnian Sea.

The lowest dry weight values in the surface layer (0.08-0.09 g cm<sup>-3</sup>) were sampled with the Niemistö A and Limnos corers and the highest (0.15-0.17 g cm<sup>-3</sup>) with the Sprut POL and Large Box Corer. The highest peak concentration of Cs-137 (4700 Bq kg<sup>-1</sup> dry wt.) was recorded in the 5-6 cm slice taken with the Limnos corer, but the highest total amount of Cs-137 in the whole sediment profile was obtained with the Sprut POL. The Cs-137 profiles of different corers deviated most markedly from each other at this station (Fig. 10), as well as the total amounts of Cs-137, which ranged from 2,600 to 35,200 Bq m<sup>-2</sup>. Even the parallel cores taken by the Aquarius, Limnos, Sprut POL, Sprut RUS and Niemistö A differed considerably from each other. Traces of smearing effect were obvious in the Cs-134 profiles of almost all the corers (Fig. 11). In the cores taken by the Niemistö G and Limnos, the Pu-239,240 peak occurred in the 8-10cm or 10-12cm slice, but in those taken by Sprut they were roughly twice as deep.

### Station EB-1

At station EB-1 (135 m) in the central Bothnian Sea, the type of sediment is more compact than at the other stations. Due to the oxic conditions in the near-bottom water, the uppermost layers of sediment are affected by strong bioturbation. At this station the total amounts of Cs-137 in the whole sediment profiles were higher than at any other station.

The lowest dry weight values in the surface layer ( $0.20\text{-}0.22\text{ g cm}^{-3}$ ) were sampled with the Niemistö A, Sprut RUS, Niemistö G, Aquarius and STUK corers and the highest ( $0.26\text{-}0.29\text{ g cm}^{-3}$ ) with the Sprut POL and Selena corers. The highest peak concentration of Cs-137 ( $1750\text{ Bq kg}^{-1}$  dry wt.) was obtained from the surface sediment layer with the Sprut RUS (Fig. 12), as well as the highest total amount in the whole sediment profile ( $46,700\text{ Bq m}^{-2}$ ). Quite comparable results were obtained with Sprut RUS, Aquarius, Niemistö G, Selena, STUK and Niemistö A.

In some of the cores, relatively high concentrations of Cs-134 were obtained from sediment layers below 10 cm, which is probably due to the smearing effect (Fig. 13). The Pu-239,240 peak occurred at a depth of 8-10 cm in the cores taken using the Sprut POL and Small Box Corer, but in the 10-15 cm slice in the core taken using the STUK corer.

### *Statistical considerations*

Statistical analysis of the MOSSIE data proved to be difficult or even impossible. A general problem in analysis of this kind of data is that it is difficult to determine the "best result", i.e. the reference value. The use of a mean value or median in this context is generally not correct, because in many cases a maximum or a minimum value can be argued to be the best result (e.g. the highest total amount of Cs-137 in the profile).

Especially in the MOSSIE data, the main weakness was in the planning of the sampling, which was not systematic enough. To be able to examine the data statistically, the samples should always be taken with the same set of corers and always using the same slicing. In addition, a sufficient number of parallel cores should be taken with each corer. The present data include plenty of separate results without parallel samples, so it is impossible to determine the error and confidence limits, for instance. One specific problem in the MOSSIE data was the considerable differences between some of the corers, and consequently the incoherence of the results.

The significance of small differences in sampling positions relative to the patchiness of radionuclides in sediments and sedimentation rates is an open question. It was stated above that the result may differ markedly, even at sampling points situated very close to each other. During the MOSSIE exercise the exact sampling positions might sometimes differ slightly in the case of the numerous cores taken from an individual ship, and especially between the two ships. When the ships were at station XV-1 at the same time, the distance between them was about 0.5 nmi. Elsewhere the ships visited the stations separately.

Nevertheless, serious efforts were made to find statistical differences in the results obtained with different corers. The following criteria were used independently to examine the results:

- 1) The corer yielding the lowest dry weight ( $\text{g cm}^{-3}$ ) for the surface layer was chosen as the reference corer
  - deviation may indicate an appearance of scavenging
- 2) The corer yielding the highest Cs-137 (peak) concentration ( $\text{Bq kg}^{-1}$  dry wt.) in some of the sections was chosen as the reference corer
  - deviation may indicate eventual scavenging, mixing or smearing, etc.
- 3) The corer yielding the highest total amount ( $\text{Bq m}^{-2}$ ) in the whole sediment profile was chosen as the reference corer
  - deviation may indicate scavenging, loss of enclosed material, etc.
- 4) The corer with a total Cs-137 in the profile nearest to the median was chosen as the reference corer
  - in this context, the use of a median is not generally correct (see above)

5) The corer that was nearest to the FIN Niemistö Corer in total Cs-137 ( $\text{Bq m}^{-2}$ ) was chosen as the reference corer

- before and during the MOSSIE exercise the Niemistö Corer was the corer most frequently used in sediment sampling by the MORS Group. The FIN Niemistö was chosen as the reference, because this particular corer and the sampling technique used represented the original version of the device (*cf.* Niemistö, 1974).

Tukey's Studentized Range (HSD) Test for Difference (SAS Institute Inc., 1989) was used for the whole material, including the results from all the stations and corers. The test results show that if the lowest dry weight in the surface layer or the highest peak concentration of Cs-137 is used as the reference, none of the corers differs significantly from the others, i.e. in this respect the corers fall into the same group (Tables I and II).

If the highest total Cs-137 value per  $\text{m}^2$  is used as the reference, the Large Box Corer differs significantly from the Selena, STUK, Aquarius and Sprut corers (Table III). If the median of total Cs-137 values is used as the reference, the Large Box Corer differs significantly from the Aquarius, Sprut and Niemistö GER corers (Table IV). On the other hand, if the Niemistö FIN Corer is used as the reference, only the Limnos Corer differs significantly from the Large Box Corer (Table V). In general, however, the incoherence of the results hampered the use of Tukey's test for this material.

Another simplified method for testing the differences between the corers was to calculate the relative differences from the reference corer:

$$\frac{\text{value} - \text{reference}}{\text{reference}}$$

The results of these tests are given in Figs 14-17. At station BY-15 the Large Box Corer was eliminated, because there were no useable Cs-137 results (all were "less than" values). Based on this examination a rough ranking list was drawn up for the corers used at the four sampling stations. In addition to criteria 1-5 given above, opposite "negative" items were included in the ranking categories:

- 6) The corer with the highest dry weight ( $\text{g cm}^{-3}$ ) in the surface layer
- 7) The corer with the lowest Cs-137 peak ( $\text{Bq kg}^{-1}$  dry wt.) in any of the surface layers
- 8) The corer with the lowest total Cs-137 ( $\text{Bq m}^{-2}$ ) in the whole profile
- 9) The corer with a total Cs-137 ( $\text{Bq m}^{-2}$ ) farthest from the median
- 10) The corer with a total Cs-137 ( $\text{Bq m}^{-2}$ ) farthest from the FIN Niemistö Corer

#### 11) Outliers

The ranking list is given in Table VI. The Sprut Corers were considered as one type irrespective of whether they were used by Poland or Russia, because the corers were identical in every respect. The Niemistö Corer used on the *Aranda* (A) was considered separately from that used on the *Valdivia* (G) due to the different diameter of the coring tubes. However, the Niemistö Corer used on board the *Aranda* was considered as one type, whether it was used by Finland or by Sweden.

In the first category, "lowest dry weight in the surface layer", the original Niemistö Corer used on board the *Aranda*, the Niemistö G, Gemini and Sprut corers obtained most of the top ranks. In the opposite category, "highest dry weight in the surface layer" the Large Box Corer, the Small Box Corer and also the Sprut Corer gathered most of the negative top ranks.

In the second category, "highest Cs-137 peak", the Niemistö G, Sprut and Gemini corers obtained most of the top ranks, whereas the Large Box Corer and the Small Box Corer and again the Sprut Corer gathered most of the negative top ranks in the opposite category, 7.

In the third category, "highest total Cs-137 in the whole profile", the Sprut, Aquarius and Niemistö G corers obtained most of the top ranks, whereas the Large Box Corer, the Small Box Corer and the Niemistö A Corer obtained most of the negative top ranks in the opposite category, 8.

In the fourth category, "total Cs-137 in the profile nearest to median", the Sprut, Gemini and Aquarius corers obtained most of the top ranks. The Large Box Corer, the Small Box Corer and the Sprut Corer obtained most of the top ranks in the opposite category, 9, but the Sprut Corer and the Aquarius Corer also gathered top ranks at two stations.

In the fifth category, "nearest to FIN Niemistö Corer in total Cs-137", the Sprut Corer and the Gemini Corer obtained most of the top ranks. However, the Sprut Corer, together with the Large Box Corer and the Aquarius Corer, also gathered most of the top ranks in the opposite category, 10.

In three cases the Large Box Corer was so far from the reference that it was categorised as an outlier. The Small Box Corer was considered an outlier in two cases.

#### *Impact of corer diameter or area*

The impact of corer diameter (or area) was considered using the Finnish data collected on board the *Aranda* by six corers with different diameters (or areas). Only the Finnish data were used in this respect, because of the uniformity of the relevant results. In principle all the six corers were used in the same way, and the results did not include any outliers.

According to some publications (e.g. Baxter et al., 1981), it has been suggested earlier that small-diameter gravity coring or other techniques using heavy and high-velocity devices may induce extensive loss of surface material and mixing of sediment layers. However, it seemed obvious that the major problem was due to the high velocity at which the corers enter the sediment, resulting in a "shock wave" effect (Evans&Lasenby, 1984). In our case, all six corers were lowered into the sediment at a very slow velocity and the results show that the differences between the corers were not caused by scavenging or mixing, but seem to have been caused by a factor that we call "edge effect" (cf. p. 2).

The consequences of the edge effect were clearly visible in the Finnish MOSSIE results (Ilus et al., 1994), which showed marked differences in the total amounts of Cs-137 per m<sup>2</sup>, even though the Cs-137 concentrations per kg of dry weight were equal in parallel slices of the sediment profiles. The results calculated per m<sup>2</sup> were in direct correlation with the area of the corer, being lowest in the corers with the smallest diameter (Fig. 18). The correlation between the total amount of Cs-137 per m<sup>2</sup> and the area of the corer was very significant, whereas no correlation was found between the Cs-137 value per kg of dry weight in the surface layer and the area of the corer (Fig. 19). The conclusion was that edge effect probably occurs in any type of coring device (the inner walls of the coring tubes/barrels cause loss of material from the margins of the core). This loss is greater in corers with higher ratios between the inner perimeter and the sampled area (in corers with small diameters), and the error is multiplied when several parallel samples are needed for analysis when small-diameter corers are used. In this calculation we used the maximum Cs-137 value per m<sup>2</sup> as the best estimate of the total amount of Cs-137 in sediments, and the Cs-137 concentration in the sample with the lowest dry weight in the 0-5 cm layer as the best estimate for the values per kg of dry wt.

## CHARACTERISTICS OF THE SAMPLING DEVICES USED IN THE MOSSIE EXERCISE

The sediment samplers used in the MOSSIE exercise includes 5 box corers and 7 tubular gravity corers. The sources of error inherent in small-diameter corers are the main disadvantages of the **Niemistö Corer**. The consequences of the edge effect have been obvious in some intercomparisons, in which the results given per m<sup>2</sup> have been smaller than expected in samples taken by the Niemistö Corer (Aarkrog and Dahlgaard, 1989; Klemola et al., 1991). Another disadvantage is its tendency to tilt on compact bottoms, because the corer is quite tall, and its centre of gravity is high up. This factor, together with the small diameter, may lead to the smearing effect. On the other hand, the soft watery surface layers are almost always undisturbed in samples taken with the Niemistö Corer, and its slicing device is one of the most sophisticated.

The **Gemini Twin Corer** is an advanced version of the Niemistö Corer, featuring many improvements. The most significant advantage is the larger diameter of the coring tubes, which means a lower risk of core shortening, smearing and edge effect. In addition, the larger diameter and 2 parallel tubes mean that the number of parallel hauls can be reduced; normally one haul is sufficient to obtain an adequate sample for radionuclide analysis. The parallel tubes and placing of the lead weights further down than in the Niemistö Corer increase the stability of the Gemini Corer and reduce the risk of tilting. An additional improvement is the locking of the upper lids and the closing rudders during descent, which increases the corer's stability and the free flow of water through the sampling tubes. The slicing device is a modification of that in the original Niemistö Corer, and is also very neat and sophisticated.

The **STUK** Corer is a very simple basic model of a tubular gravity corer. It is very safe to operate and regularly takes good-looking sediment samples with an undisturbed surface. However, core shortening caused by the relatively small diameter is one of the disadvantages recorded. Another weakness of the STUK Corer is the risk of filling up to the brim on the very soft bottoms typical of the Baltic Sea, because the corer is relatively short compared with its weight. The sectioning equipment of the STUK Corer is also very simple and not as precise as that of the Niemistö Corer. The **Selena** Corer is a "big brother" of the STUK Corer. The construction of the corer itself is identical to that of the STUK Corer, but the size is bigger. The sectioning device is not similar, instead resembling that in the Gemini Corer. The bigger corer diameter and length should reduce the disadvantages listed above for the STUK Corer.

The operational idea of the **Limnos** Sampler differs fundamentally from the other corers used in the MOSSIE exercise. In general the cores obtained with the Limnos sampler are undisturbed and the diameter is sufficient to minimise the disadvantages of all small-diameter corers, i.e. core shortening, smearing and edge effect. Furthermore, the cores are sliced without extrusion through the coring tube. On the other hand, the corer is very light and the construction is too weak for severe offshore conditions. Slicing may be difficult in rough weather or if the sediment is very watery and soft.

The construction of the **Sprut** Corer is complicated, so it may sometimes be cumbersome and subject to operational faults. However, the main weakness of the corer is the closing mechanism, which is constructed of flexible, wedge-shaped brass plates. Especially if the type of sediment is very soft, the plates do not keep the watery sediment inside, or they let air bubbles through, and consequently the core and the overlying water get mixed. This happened repeatedly on board the *Aranda*, but on the *Valdivia* the sampling succeeded better. If the core obtained is short or very soft, it easily gets lost when the corer is passing through the water surface, especially when working on large research vessels with high rails. The corer might be more useful on harder clay bottoms.

Use of the **Large Box Corer** and the **Small Box Corer** relies on additional on-board sampling with hand-operated coring tubes from the original box core. This method is a means of overcoming disadvantages such as core shortening and smearing. The use of large box corers, however, often involves other inherent difficulties, such as tilting, brimming, ingress of sediments into the sample box

from the outside, redistribution, resuspension and loss of enclosed matter (Blomqvist, 1992). Large box corers are often cumbersome and require the use of large research vessels. In addition, their massive construction, weight and less hydrodynamic design tend to disturb the soft surface layers of the sediment, even if flaps allow for water flow through the open box, as in these devices. A supporting stand or frame is used to reduce tilting and brimming. However, the Large Box Corer, specifically proved to be too heavy for the soft bottoms of the Baltic Sea, and the soft surface layers were often lost due to scavenging or brimming.

A box corer is not the best sampling device available for very soft seabeds, although it has many advantages in sampling of hard clayey and sandy sediments. It is thus obvious that the same corer may not be appropriate in all cases, and that different bottoms and circumstances require different devices. On very soft bottoms the main disadvantage of the box corer is its rather massive design, which causes loss of very soft surface sediments and makes of the corer sink too deeply into the sediment, resulting in brimming of the coring barrel.

The smaller **Aquarius** Box Corer is also equipped with a frame to avoid tilting and filling up to the brim. In addition, it is lighter and handier than the large box corers and allows water flow through the open box during descent and penetration into the sediment. Sample handling relies on an inner Plexiglas box (aquarium) that can be removed from the corer, after which the entire core can be thinly sliced using a sectioning device modified from that in the Niemistö Corer. Scavenging may be the main risk in use of the Aquarius Box Corer. However, very good samples were obtained in careful sampling with this corer during the MOSSIE exercise. Before the corer was equipped with the frame, tilting often caused the appearance of a wedge-shaped gap in one edge of the core, but the frame reduced this disadvantage.

## CONCLUSIONS

To be able to study sedimentation and processes in sediments, it is essential to obtain reliable samples. False conclusions are an obvious risk if the studies are based on biased field samples, and it is unreasonable to perform exacting and expensive analyses if the samples themselves are unreliable or of poor quality. Sampling of soft, easily resuspended sediments, however, is difficult and involves many sources of error. In many cases the surface of the sediment is like a "line drawn in water", because the uppermost sediment layers usually consist of very light, mobile particles. Thus, sampling of sediments is one of the most demanding tasks in marine research. Different sources of error are associated with different sampling equipment, and probably there is no single corer which is ideal for all kinds of sediments.

Despite the large variety of sampling instruments and the many sources of error involved in the use of different instruments, it is vital to know and account for the disadvantages and to work as reliably and carefully as possible to minimise errors and obtain undisturbed and reliable samples.

The instruments best suited to quantitative sampling of soft-bottom sediments appear to be those based on the coring principle. Box corers can be reliably used mainly for bulk sampling of coherent sediments and some silty and sandy sediments. Nevertheless, it should be borne in mind that the same instrument may not be the best alternative for all types of bottom, and different circumstances require different types of instrumentation.



The aim of each given study should determine what kind of sampling equipment should be used. If the aim is to study the distribution of recently settled radionuclides in the uppermost layers of sediment, for instance, the criterion should be the most exact slicing system, even if the diameter of the corer is small. When monitoring total amounts of radionuclides in sediments, the best choice might be a corer with a large sampling area. The most important criterion should be, however, that the corer used is able to take undisturbed samples of good quality (unmixed surface layer, clear water layer above it, etc.).

Many factors speak in favour of corer orifices with relatively large diameters/areas. It is not possible, however, to increase the tube diameter endlessly without having a negative impact on the corer's handiness and making it more difficult to handle and slice the cores.

In this study the main emphasis was placed on comparing the sampling devices in order to find the best available instrumentation for Baltic Sea sediments. Intercomparison of analysis methods and results has shown good comparability between the participating laboratories (Ballestra et al., 1994).

Typical sources of error involved in sampling with the corers tested were as follows:

- **Aquarius:** potential risk of scavenging or tilting. Slicing, not as precise as in tube corers with a smaller diameter.
- **Gemini:** low risk of smearing, tilting or core shortening. In general this corer yields undisturbed, good-looking samples.
- **Large Box Corer:** significant risk of scavenging and filling up to the brim on the very soft bottoms of the Baltic Sea. Probably more useful on harder clay and silt bottoms.
- **Limnos:** the corer may be too light and its construction too weak for severe offshore conditions. Slicing may be difficult in rough weather or if the sediment is very watery and soft.
- **Niemistö:** the sources of error inherent in small-diameter corers (smearing, core shortening, edge effect) and the risk of tilting are the main disadvantages. On the other hand, the slicing device is one of the most sophisticated. The problems associated with small-diameter corers are probably slightly less great in the German Niemistö Corer, because its diameter is somewhat larger.
- **Selena:** potential risk of core shortening and low risk of filling up to the brim on very soft bottoms.
- **Small Box Corer:** obvious risk of scavenging and filling up to the brim on the very soft bottoms of the Baltic Sea. Probably more useful on harder clay and silt bottoms.
- **Sprut:** the main weakness is the closing mechanism of the corer, which may cause "bubbling" and mixing of the core.
- **STUK:** potential risk of brimming on very soft bottoms and core shortening are the main disadvantages recorded. In general this corer yields undisturbed, good-looking samples. Slicing is not as precise as in many other tube corers.

In general, the results obtained with the ten sediment corers were so variable and inconsistent, and the incoherence and deviations in the study material were so large that statistical analysis of the data proved to be difficult or even impossible. Five criteria were used to examine the results. The relative difference between the chosen reference corer and the other corers were determined at each sampling station based on these criteria. As a summary, a ranking list was drawn up to indicate the usability of the different sampling devices at the 4 sampling stations.

1) When the corer yielding the lowest dry weight for the surface layer was chosen as the reference corer, the average relative differences calculated for the ten corers were in the order: STUK < Niemistö G < Niemistö A < Limnos < Gemini < Selena < Aquarius < Sprut < Small Box Corer < Large Box Corer.

2) When the corer yielding the highest Cs-137 peak concentration in any of the slices was chosen as the reference corer, the order of the average relative differences calculated for each corer was as follows: STUK < Limnos < Selena < Sprut < Gemini = Niemistö A = Niemistö G < Aquarius < Small Box Corer < Large Box Corer.

3) When the corer yielding the highest total amount of Cs-137 in the whole sediment profile was chosen as the reference corer, the order of the average relative differences calculated for each corer was as follows: Selena < STUK < Aquarius < Niemistö G < Sprut < Limnos < Gemini < Niemistö A < Small Box Corer < Large Box Corer.

4) When the corer with a total Cs-137 in the profile nearest to median was chosen as the reference, the order of the average relative differences calculated for each corer was as follows: Limnos = STUK < Selena < Gemini < Aquarius < Niemistö G < Niemistö A < Sprut < Small Box Corer < Large Box Corer.

5) When the corer nearest to the FIN Niemistö Corer in total Cs-137 was chosen as the reference, the order of the average relative differences calculated for each corer was as follows: STUK < Selena < Gemini < Niemistö G < Small Box Corer < Sprut < Aquarius < Limnos < Large Box Corer.

In summary, the averages of the above mean values for each corer were:

(the value indicates the average relative difference from the reference corers; thus the lowest values differ least from the references)

* STUK	0.12
* Selena	0.22
* Limnos	0.29
Gemini	0.29
Niemistö G	0.30
Niemistö A	0.31
Aquarius	0.37
Sprut	0.38
Small Box Corer	0.70
Large Box Corer	1.02

\* these results are not fully comparable, because these corers were used only at one station

In general the results show marked differences in the total amounts of Cs-137 per square metre, even when the Cs-137 concentrations per kg of dry weight were equal. The results calculated per m<sup>2</sup> were in direct correlation with the area of the corer, being lowest in the corers with the smallest diameter. The correlation between the total amount of Cs-137 per m<sup>2</sup> and the area of the corer was very significant, whereas no correlation was found between the Cs-137 value per kg of dry weight in the surface layer and the area of the corer. We assume that this result is due to an "edge effect". The inner walls of the coring tubes/barrels cause loss of material from the margin of the corer. This loss is greater in corers with a higher ratio between the inner perimeter and the sampled area (corers with a small diameter), and this error is multiplied when small-diameter corers are used and several parallel samples are needed for analyses. However, it should be kept in mind that in spite of many disadvantages associated with the small-diameter corers, their slicing systems are generally most accurate.

Experience from this and earlier intercalibration exercises indicates that differences in sediment types and sedimentation processes should be the main arguments in selecting the sampling equipment and method. It is also clear that no universal sampler exists that meets all the requirements of sediment sampling. Consequently, this intercomparison of the results should not be considered as an exhaustive evaluation of the devices.

This exercise showed that the results obtained with different sampling devices may differ significantly. In spite of the variability of the results, the work proved valuable, because it shows how much emphasis must be put on sampling in sediment studies. In this sense it is valuable not only for scientists studying radioactive substances but for all the scientists working on sediments.

## REFERENCES

- Aarkrog A. and Dahlgaard H., 1989. Nordic intercalibration of sediment sampling and analysis 1979. Manuscript translated to English; Ø National Laboratory, Denmark.
- Ballestra S., Gastaud J., Lopez J.J., Parsi P, and Vas D., 1994. Intercomparison of radionuclide measurements in Baltic Sea sediments IAEA-300, IAEA-378 and IAEA-379. IAEA/AL/066. International Atomic Energy Agency, Marine Environment Laboratory, Monaco.
- Ballestra S, Herrmann J and Ikäheimonen T.K., 1995. Quality of data. In: Radioactivity in the Baltic Sea 1984-1991. Baltic Sea Environment Proceedings 61: 30-58. Helsinki Commission, Helsinki
- Baxter M.S., Farmer J.G., McKinley I.G., Swan D.S. and Jack W., 1981. Evidence of the unsuitability of gravity coring for collecting sediment in pollution and sedimentation rate studies. Environmental Science & Technology 15: 843-846.
- Blomqvist S., 1985. Reliability of core sampling of soft bottom sediment - an *in situ* study. Sedimentology (1985) 32, 605-612.
- Blomqvist S., 1992. Geochemistry of coastal Baltic sediments: Processes and sampling procedures. Meddelanden från Stockholms universitets institution för geologi och geokemi. N:r 285, Stockholm.
- Evans H.E. & Lasenby D.C., 1984. A comparison of lead and zinc sediment profiles from cores taken by diver and a gravity corer. Hydrobiologia 108, 165-169.
- Ilus E., 1996. Evaluation of sediment sampling devices and methods used in the NKS/EKO-1 Project. Technical Report of Nordic Nuclear Safety Research NKS/EKO-1(96)TR-1, Risö, Denmark.
- Ilus E. (ed.), 1998. Dating of sediments and determination of sedimentation rate. Proceedings of a seminar held in Helsinki 2-3 April 1997. Report STUK-A145, 149 pp., Radiation and Nuclear Safety Authority, Helsinki.
- Ilus E., Mattila J., Klemola S., Ikäheimonen T. and Niemistö L., 2000. Sedimentation rate in the Baltic Sea. Technical Report of Nordic Nuclear Safety Research NKS/EKO-1(2000)TR-x, Risö, Denmark. (in press).
- Ilus E., Niemistö L. and Bojanowski R., 1995. Radionuclides in sediment and suspended particulate matter. In: Radioactivity in the Baltic Sea 1984-1991. Baltic Sea Environment Proceedings 61: 69-92. Helsinki Commission.
- Ilus E., Niemistö L. and Ikäheimonen T.K., 1994. The Finnish MOSSIE results. HELCOM/MORS Seminar "Internal and external quality assurance, and the preliminary review of the MOSSIE data" held in Helsinki, 30 May 1994, Finnish Centre for Radiation and Nuclear Safety.
- Jahnke R.A. and Knight L.H., 1997. A gravity-driven, hydraulically-damped multiple piston corer for sampling fine-grained sediments. Deep-Sea Research I, 44, 713-718.
- Klemola S., Ilus E, Sjöblom K-L., Arvela H. and Blomqvist L., 1991. Monitoring of radionuclides in the environs of the Finnish nuclear power stations in 1988. Appendix: Intercomparison of sediment samplers. Report STUK-A92: 62-68, Finnish Centre for Radiation and Nuclear Safety, Helsinki.
- Morton R.A. and White W.A., 1997. Characteristics of and corrections for core shortening in unconsolidated sediments. Journal of Coastal research, 13(3), 761-769, Fort Lauderdale (Florida).

Nevissi A.E., Shott G.J. & Crecelius E.A., 1989. Comparison of two gravity coring devices for sedimentation rate measurement by  $^{210}\text{Pb}$  dating techniques. *Hydrobiologia* 179: 261-269.

Nies H., Albrecht H., Rechenberg V., Goroncy I., Dahlgaard H., Weiss D., Brüggmann L., 1990. Intercomparison of sediment sampling techniques by means of radionuclide and heavy metal analyses. *Dt. hydrogr. Z.* 43, 27-53, Hamburg.

Niemistö L., 1974. A gravity corer for studies of soft sediments. *Merentutkimuslait. Julk./Havsforskningsinst.Skr.* 238: 33-38, Helsinki.

Povinec P., Fowler S. and Baxter M., 1996. Chernobyl & the marine environment: The radiological impact in context, *IAEA Bulletin*, 38,1: 18-22, International Atomic Energy Agency, Vienna.

SAS Institute Inc., 1989. *SAS/STAT\* User's Guide, Version 6 Fourth Edition, Volume 2*, Cary, NC: SAS Institute Inc., 1989, 846 pp.

Winterhalter B., 1998. *The Gemax Corer for soft sediments*. 9 pp. Geological Survey of Finland, Espoo.

**Figures**  
**6-19**

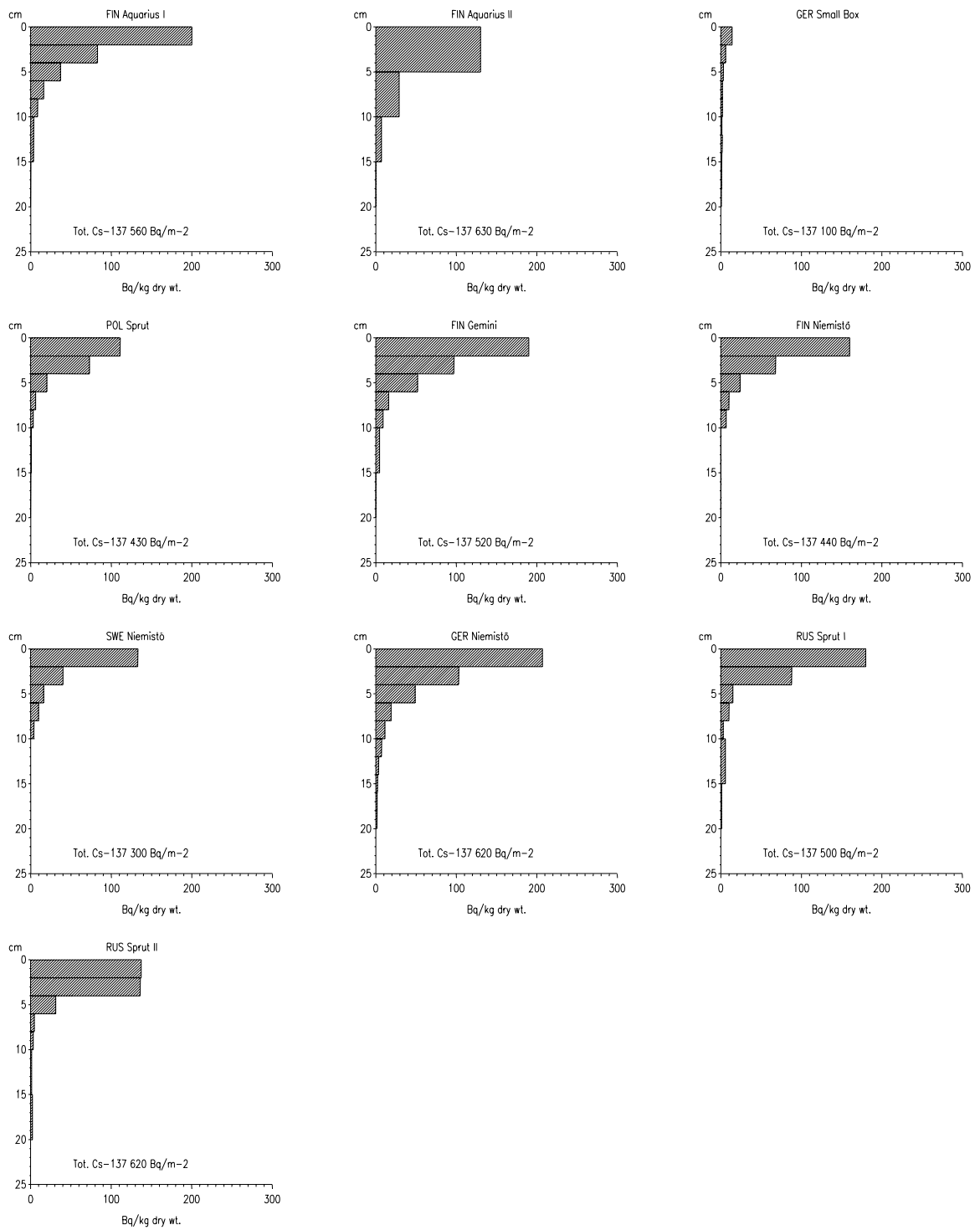

Fig. 6. Vertical profiles of Cs-137 obtained with different corers at station BY-15.

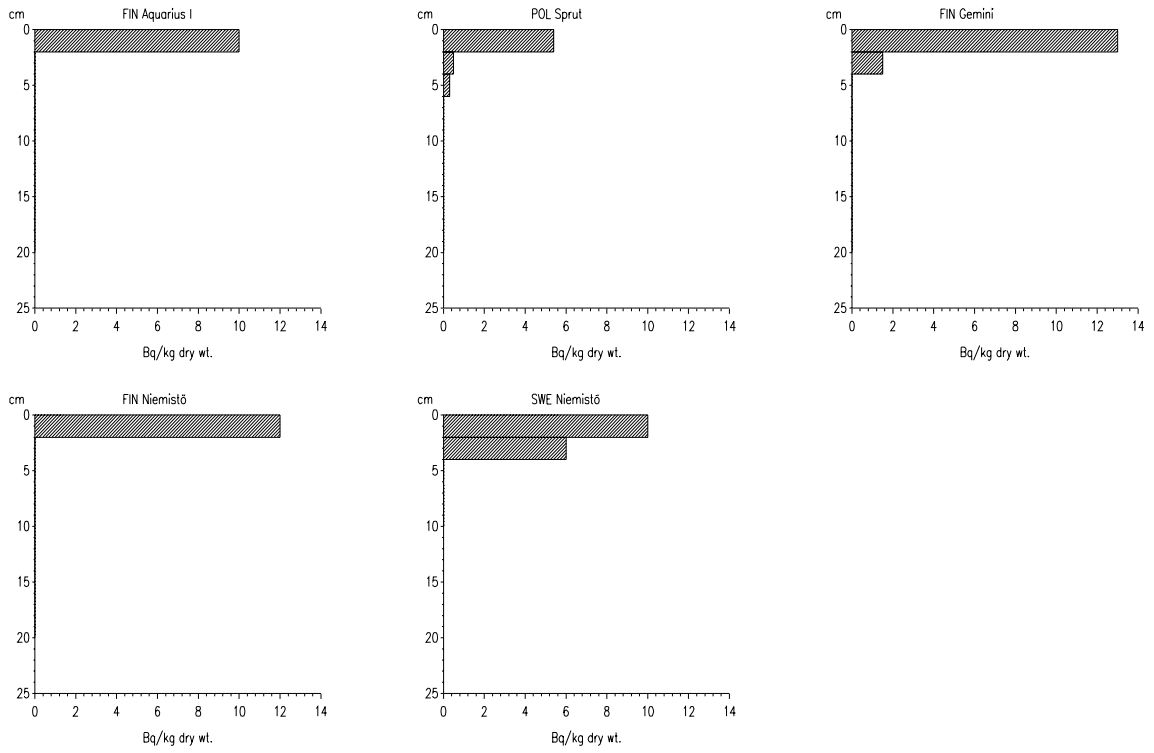

Fig. 7. Vertical profiles of Cs-134 obtained with different corers at station BY-15.

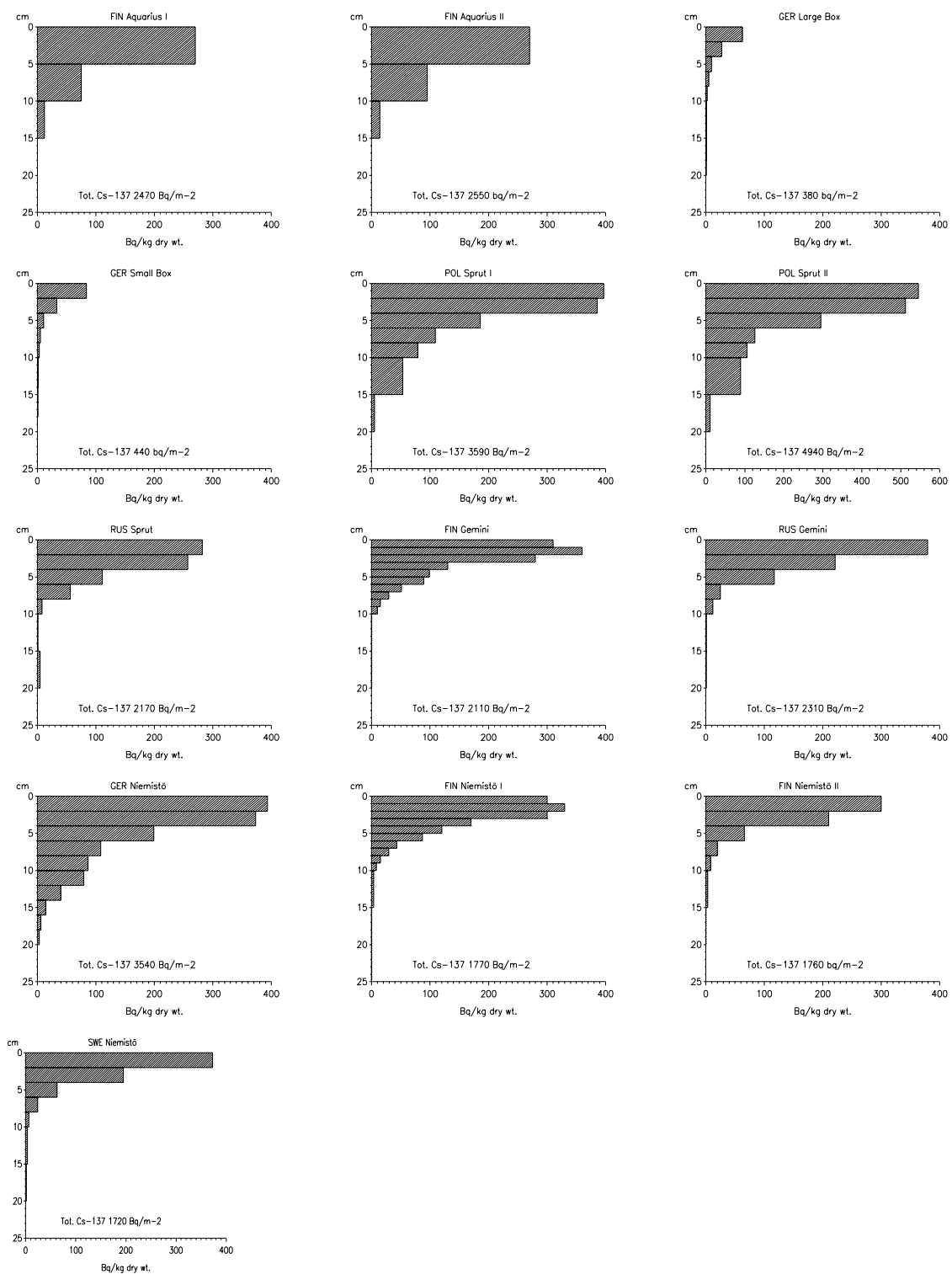

Fig. 8. Vertical profiles of Cs-137 obtained with different corers at station Teili-1.



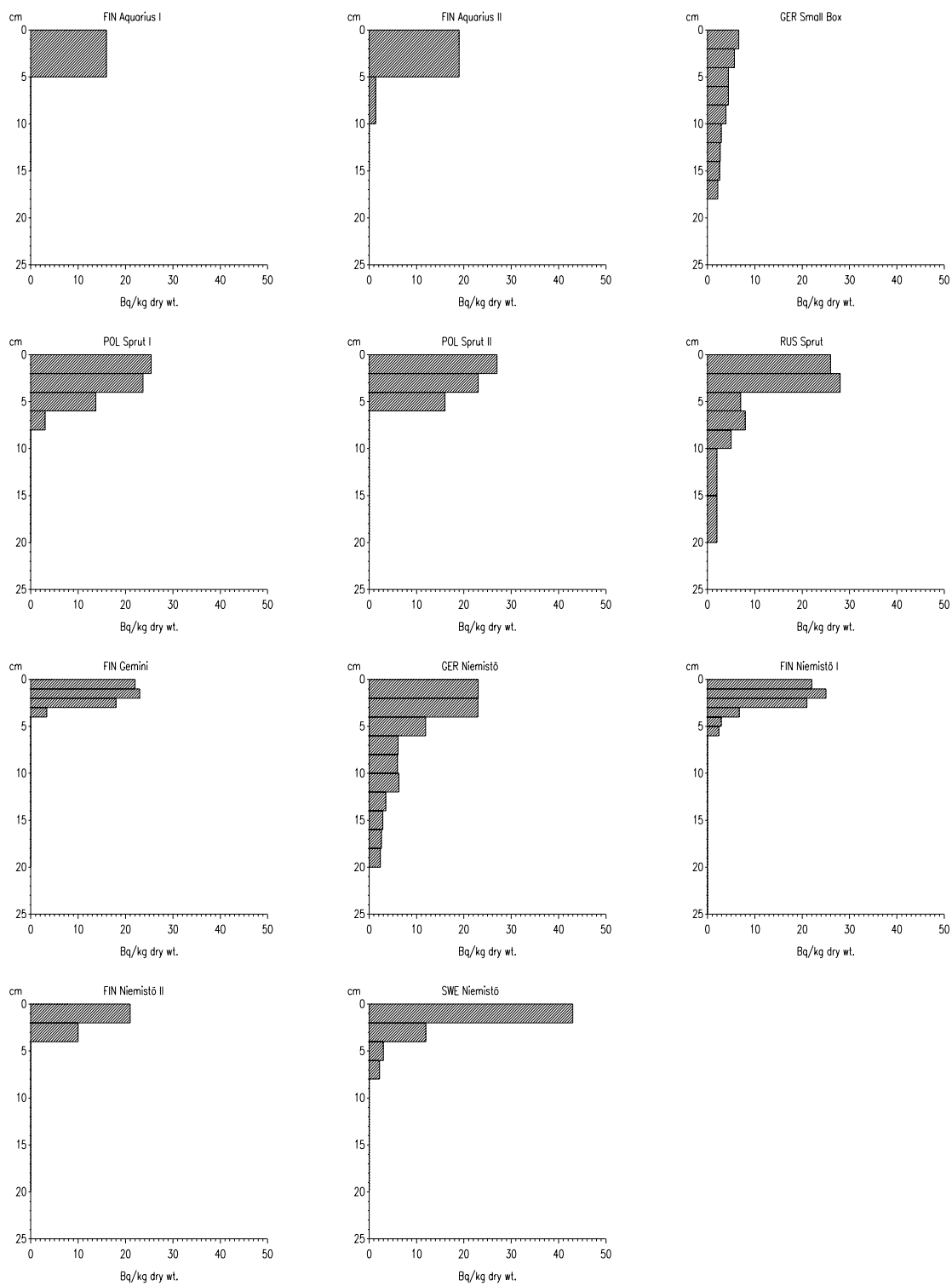

Fig. 9. Vertical profiles of Cs-134 obtained with different corers at station Teili-1.

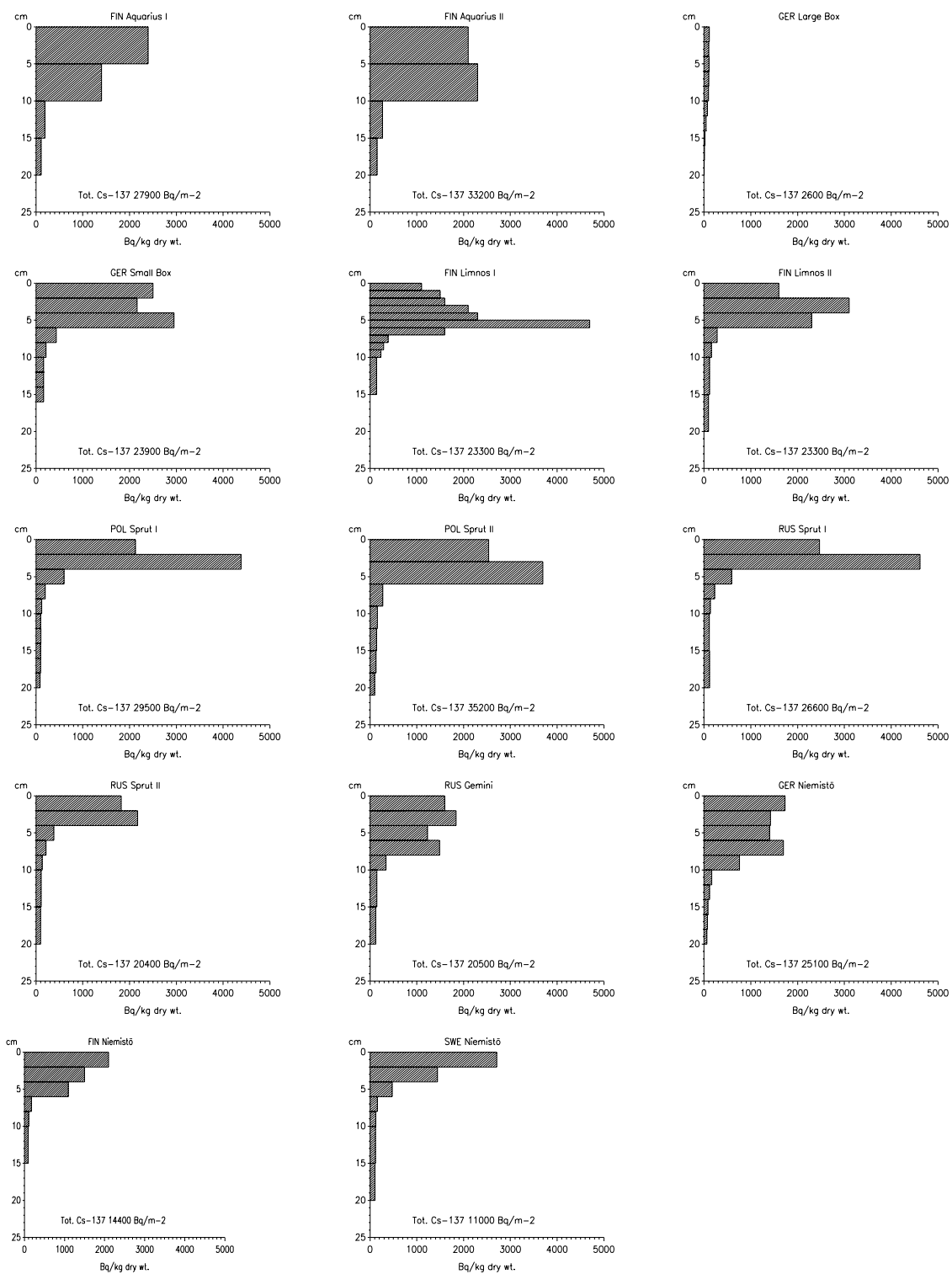

Fig. 10. Vertical profiles of Cs-137 obtained with different corers at station XV-1.

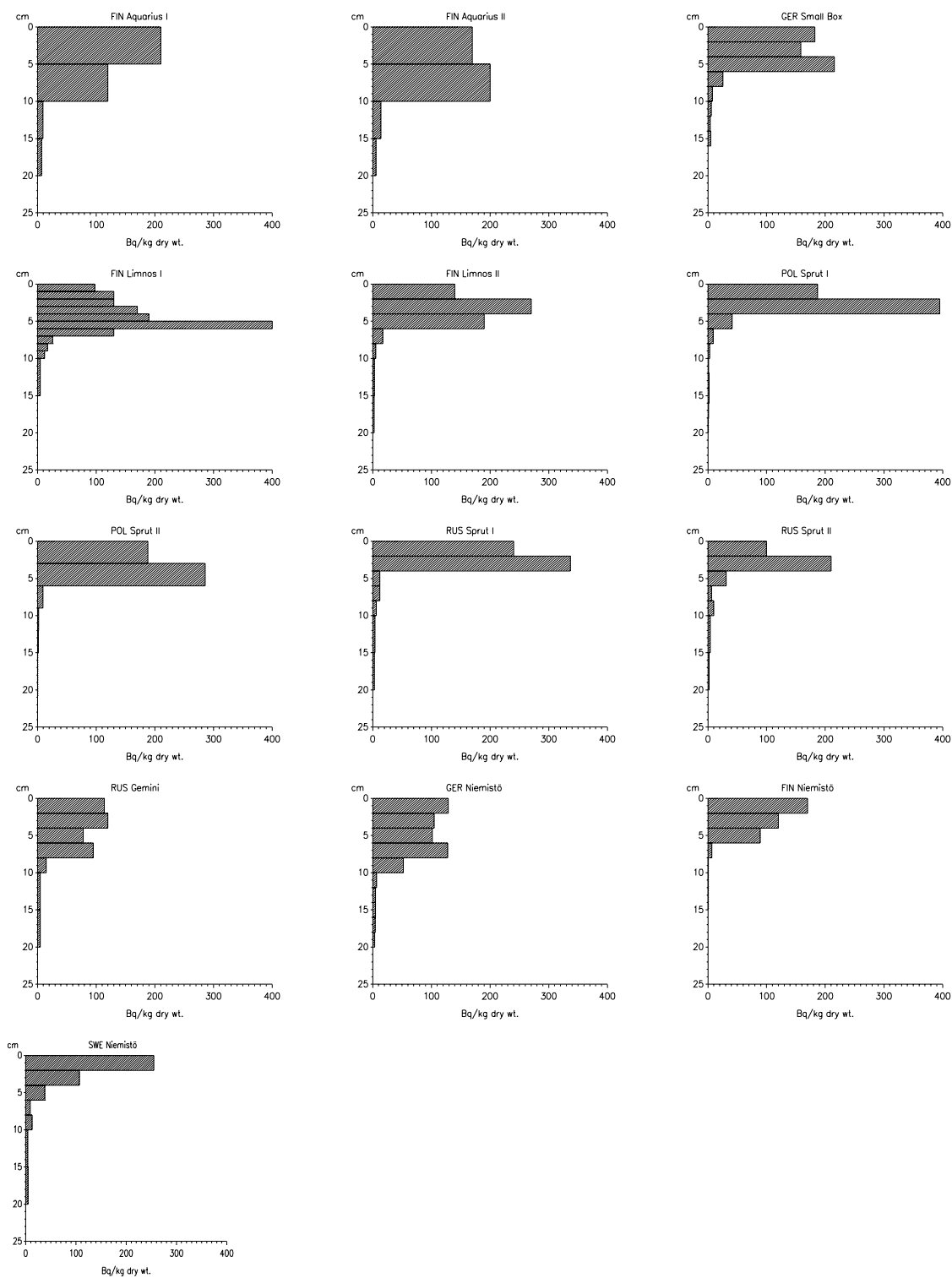

Fig. 11. Vertical profiles of Cs-134 obtained with different corers at station XV-1.

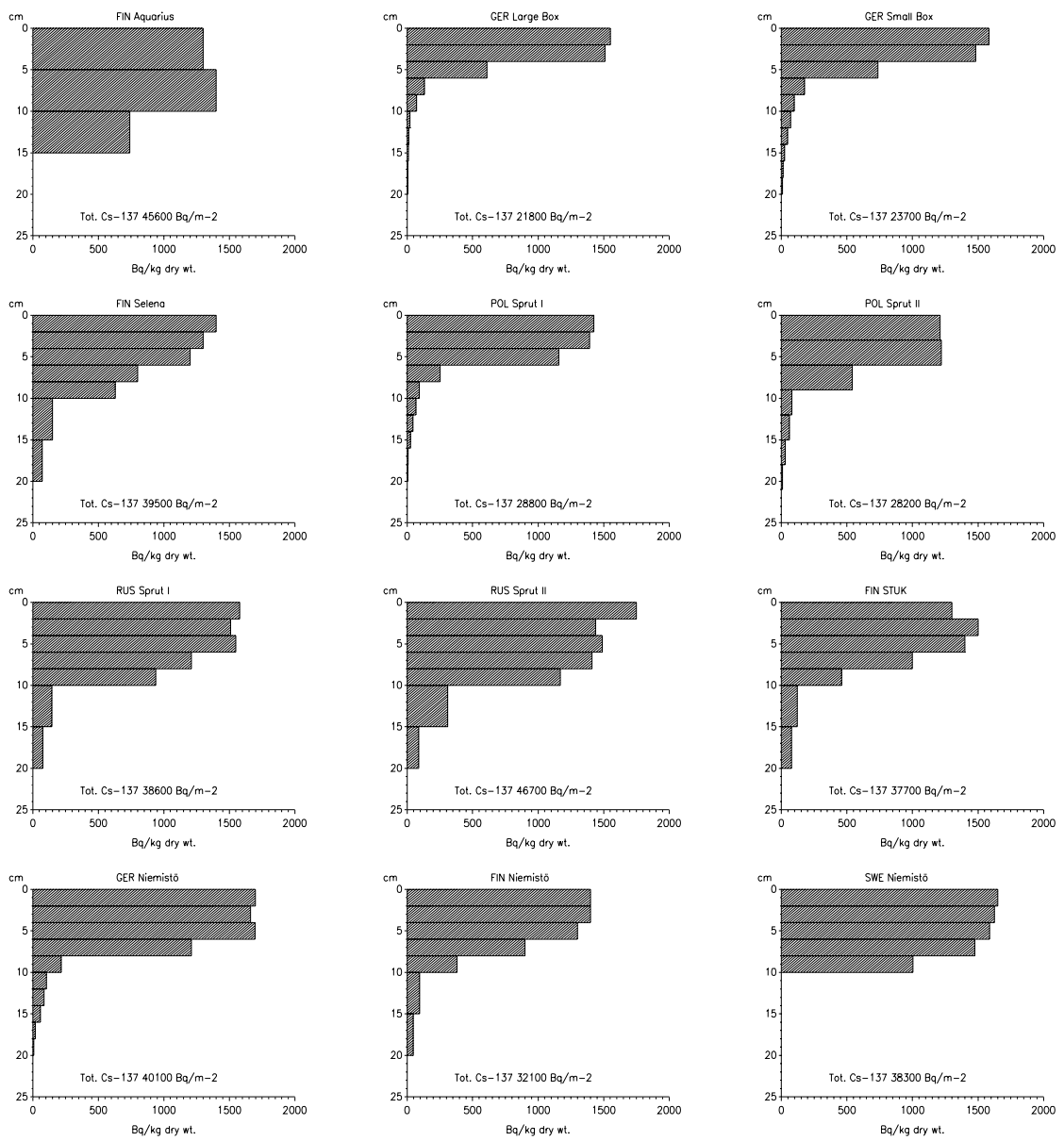

Fig. 12. Vertical profiles of Cs-137 obtained with different corers at station EB-1.

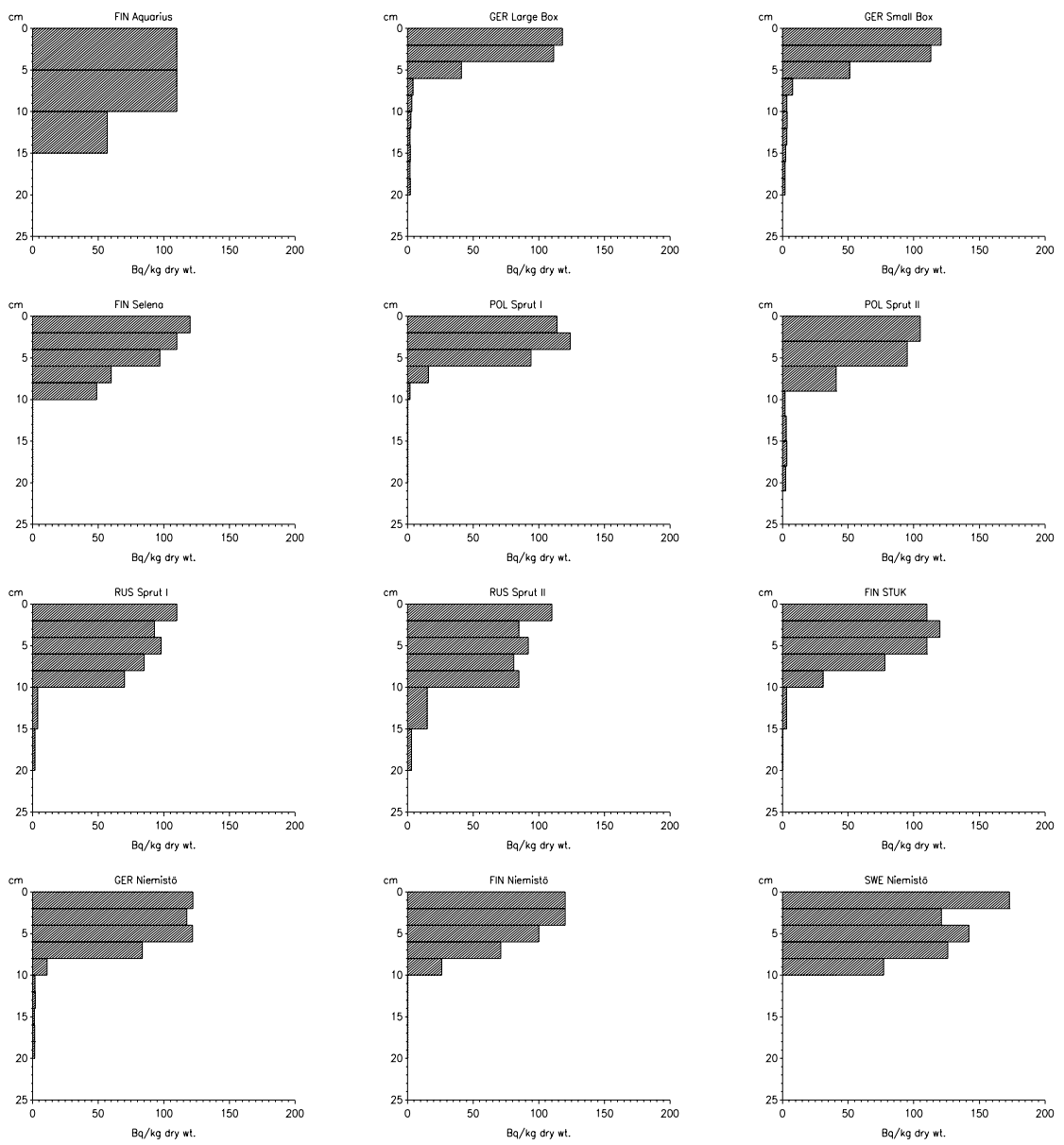

Fig. 13. Vertical profiles of Cs-134 obtained with different corers at station EB-1.

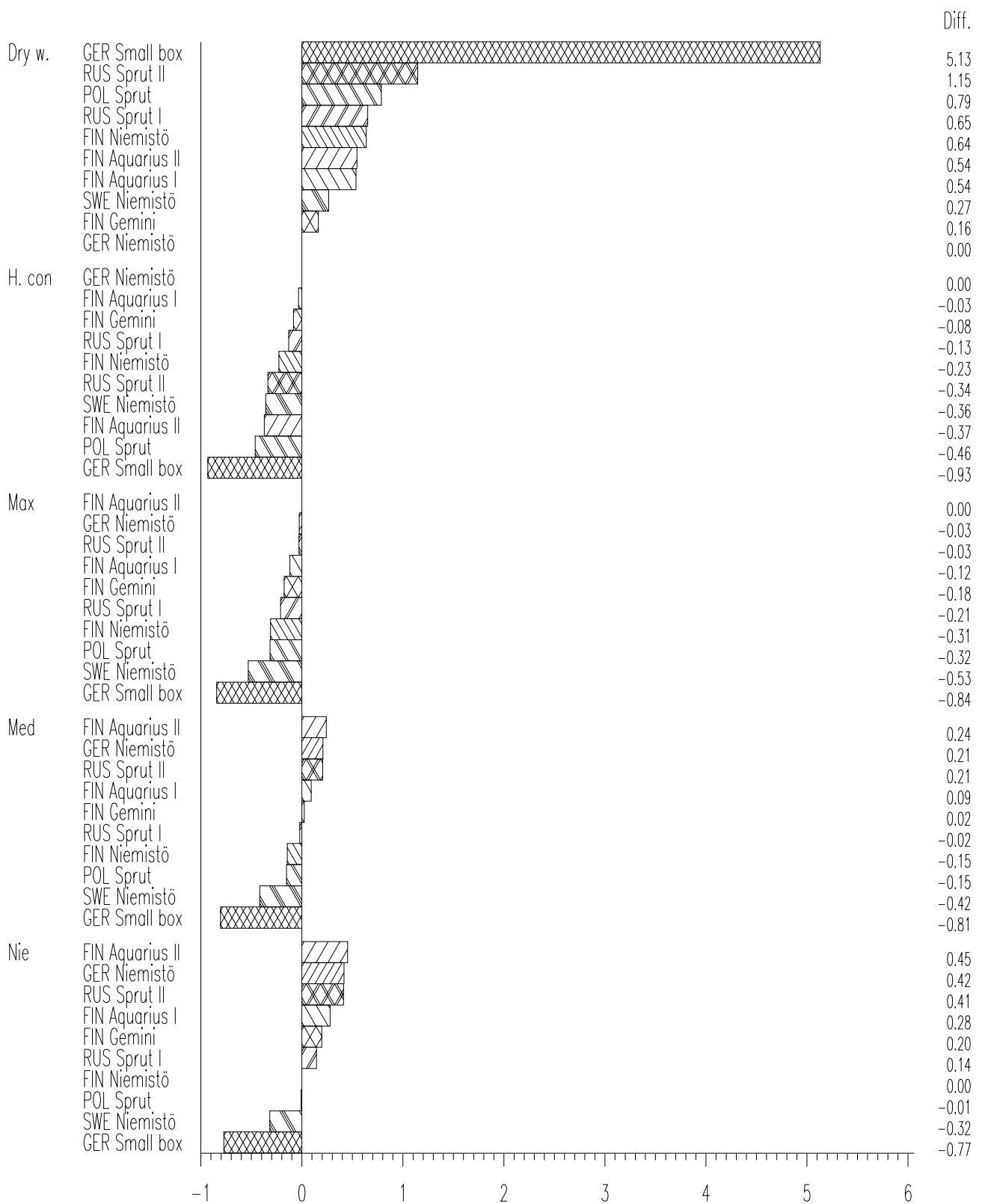

Fig. 14. Relative differences between other corers and the reference corer at station BY-15.

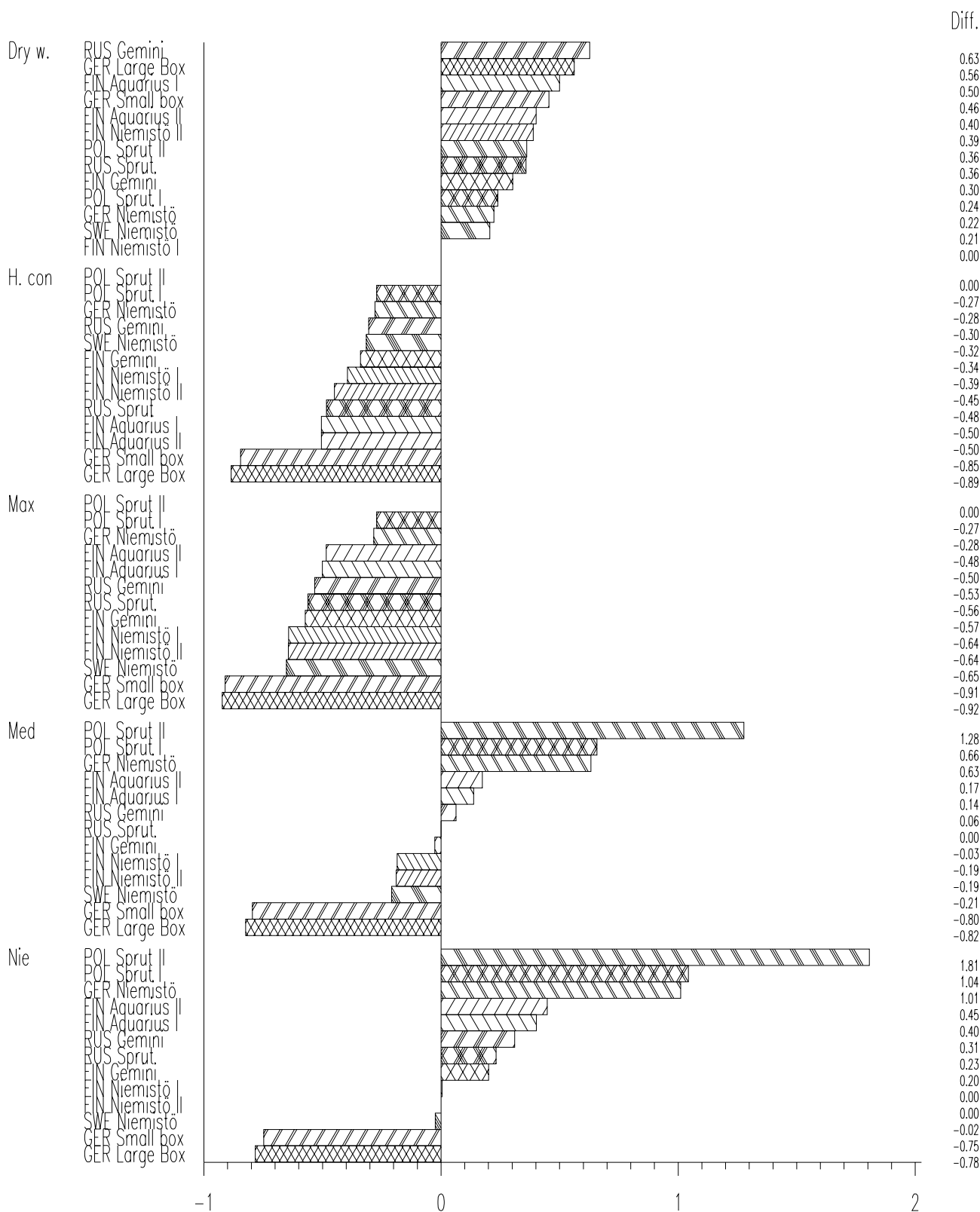

Fig. 15. Relative differences between other corers and the reference corer at station Teili-1.

Diff.

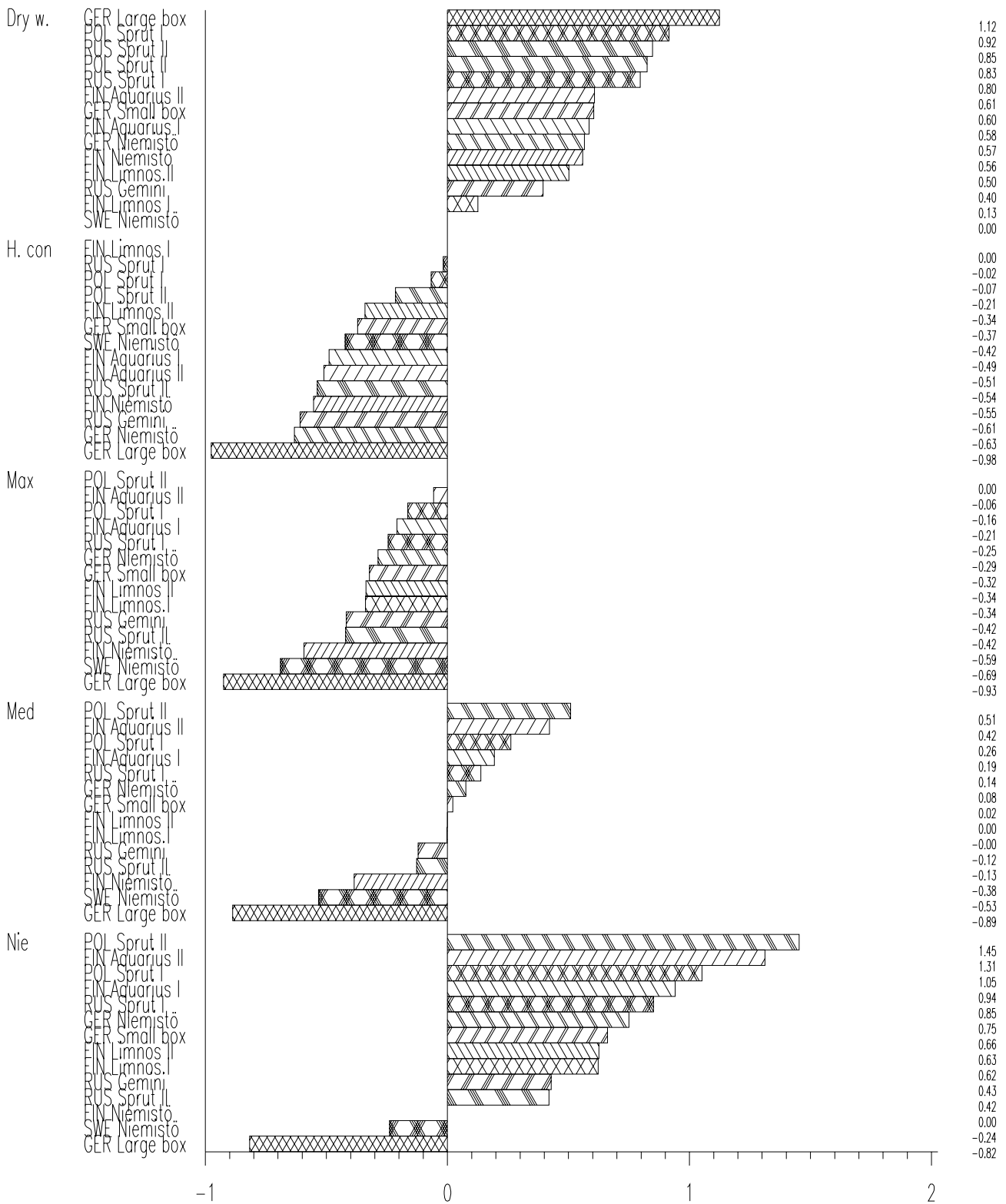

Fig. 16. Relative differences between other corers and the reference corer at station XV-1.



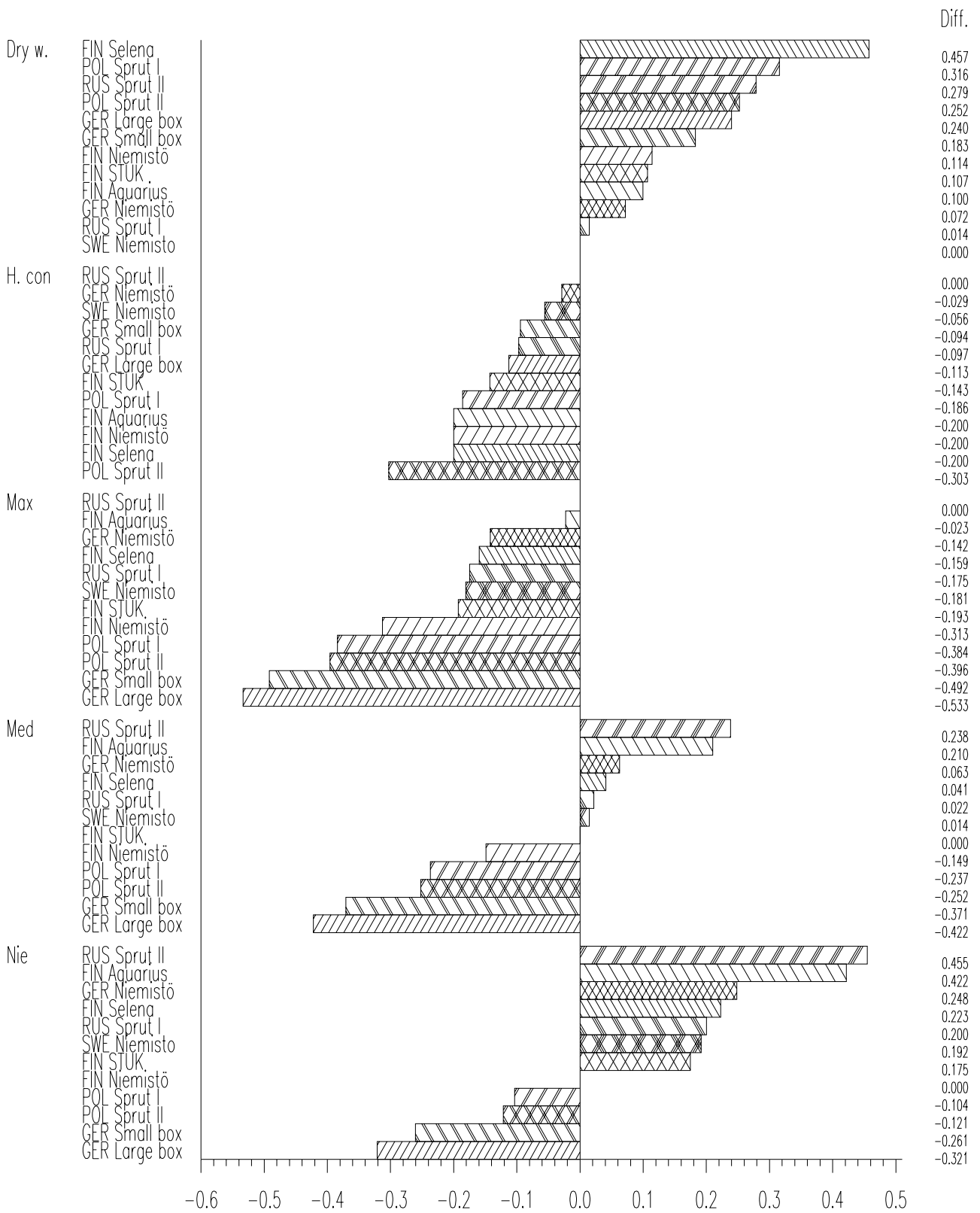

Fig. 17. Relative differences between other corers and the reference corer at station EB-1.

Std Cs = Max.Cs - Corer specific Cs per Max.Cs

F-test = 35.10 p = 0.0001 (\*\*\*)

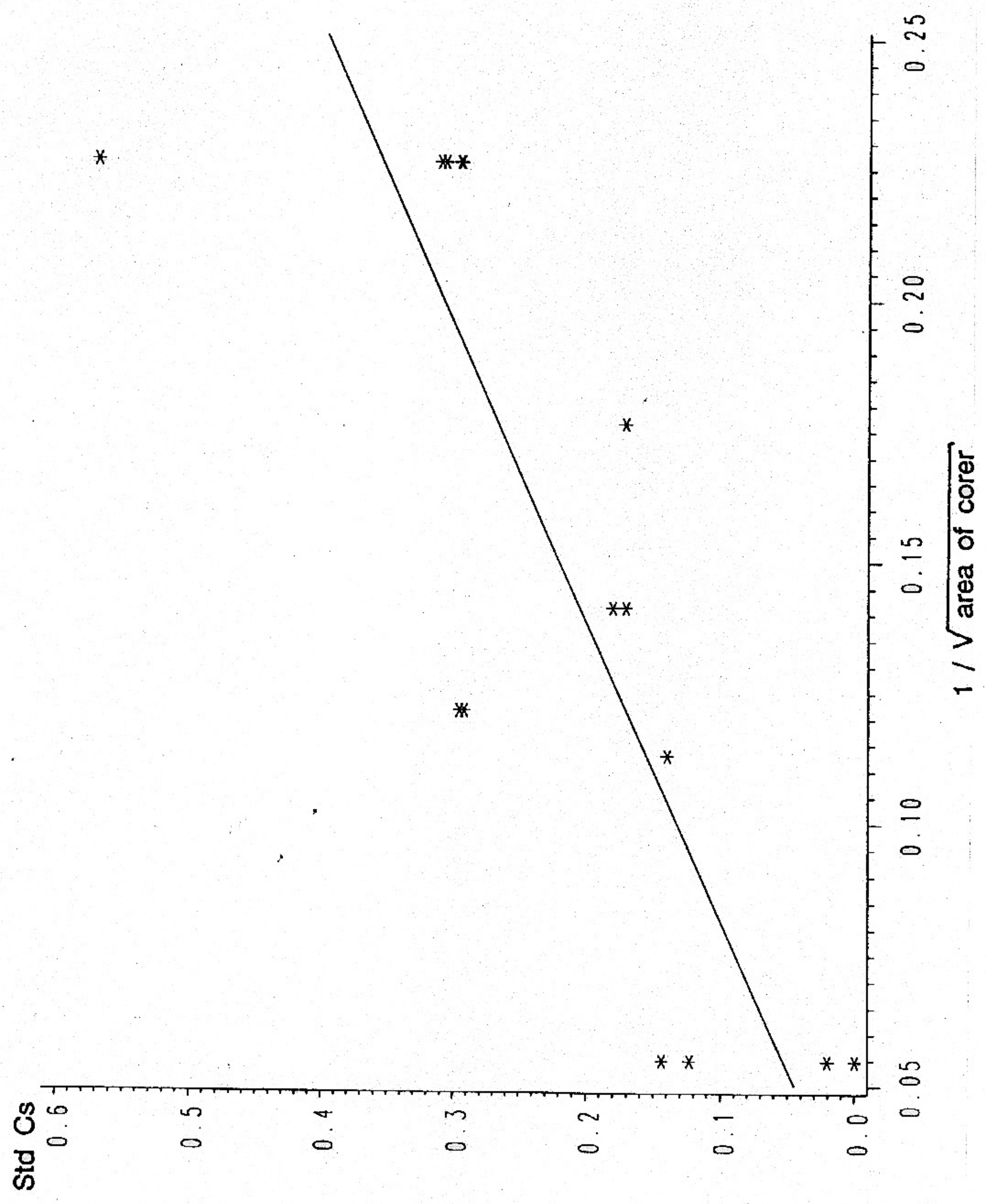

Fig. 18. Correlation between the total amount of Cs-137 per m<sup>2</sup> and the area (diameter) of the corer.

Std Cs = Cs in min.dens. - Corer spes. Cs per Cs in min.dens.

F-test = 2.20  $p = 0.157$  (-)

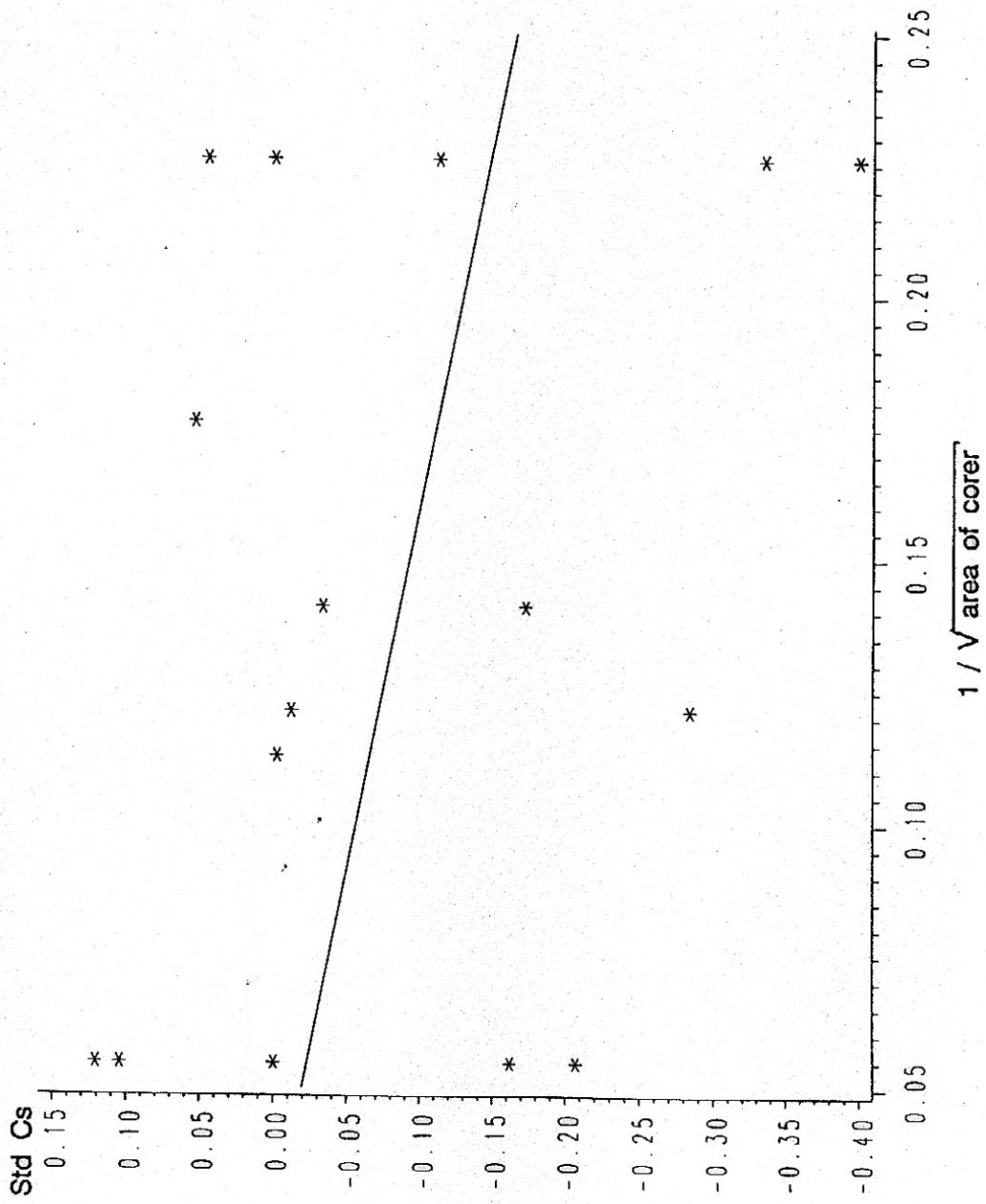

Fig. 19. Correlation between the Cs-137 concentration in surface layer (0-5 cm) and the area (diameter) of corer.

**Tables**  
**I-VI**

Table I. Results of Tukey's test, reference "lowest dry weight in surface layer".

**Reference: Surface layer (0-2 cm) with lowest dry weight**

General Linear Models Procedure

Tukey's Studentized Range (HSD) Test for variable: STDden

NOTE: This test controls the type I experimentwise error rate, but generally has a higher type II error rate than REGWQ.

Alpha= 0.05 df= 41 MSE= 0.520375  
 Critical Value of Studentized Range= 4.728  
 Minimum Significant Difference= 2.1049  
 WARNING: Cell sizes are not equal.  
 Harmonic Mean of cell sizes= 2.625547

Means with the same letter are not significantly different.

<b>Tukey Grouping</b>	<b>Mean</b>	<b>N</b>	<b>Corer</b>
A	1.3108	5	SMALL BOX
A			
A	0.6418	3	LARGE BOX
A			
A	0.5564	14	SPRUT
A			
A	0.4677	7	AQUARIUS
A			
A	0.4573	1	SELENA
A			
A	0.3720	4	GEMINI
A			
A	0.3139	2	LIMNOS
A			
A	0.2853	5	NIEMISTÖ G
A			
A	0.2412	9	NIEMISTÖ A
A			
A	0.1069	1	STUK

Table II. Results of Tukey's test, reference "highest peak concentration of Cs-137".

**Reference: Highest (peak) concentration of Cs-137**

General Linear Models Procedure

Tukey's Studentized Range (HSD) Test for variable: STDCs-137

NOTE: This test controls the type I experimentwise error rate, but generally has a higher type II error rate than REGWQ.

Alpha= 0.05 df= 41 MSE= 0.059457  
 Critical Value of Studentized Range= 4.728  
 Minimum Significant Difference= 0.7115  
 WARNING: Cell sizes are not equal.  
 Harmonic Mean of cell sizes= 2.625547

Means with the same letter are not significantly different.

<b>Tukey Grouping</b>	<b>Mean</b>	<b>N</b>	<b>Corer</b>
A	-0.1429	1	STUK
A			
A	-0.1702	2	LIMNOS
A			
A	-0.2000	1	SELENA
A			
A	-0.2221	14	SPRUT
A			
A	-0.3291	5	NIEMISTÖ G
A			
A	-0.3307	9	NIEMISTÖ A
A			
A	-0.3337	4	GEMINI
A			
A	-0.3736	7	AQUARIUS
A			
A	-0.5105	5	SMALL BOX
A			
A	-0.6579	3	LARGE BOX

Table III. Results of Tukey's test, reference "highest total Cs-137 value in the whole profile".

**Reference: Highest total Cs-137 values per m<sup>2</sup>**

General Linear Models Procedure

Tukey's Studentized Range (HSD) Test for variable: STDtotCs

NOTE: This test controls the type I experimentwise error rate, but generally has a higher type II error rate than REGWQ.

Alpha= 0.05 df= 41 MSE= 0.036823  
 Critical Value of Studentized Range= 4.728  
 Minimum Significant Difference= 0.5599  
 WARNING: Cell sizes are not equal.  
 Harmonic Mean of cell sizes= 2.625547

Means with the same letter are not significantly different.

	<b>Tukey Grouping</b>	<b>Mean</b>	<b>N</b>	<b>Corer</b>
	A	-0.1595	1	SELENA
	A			
	A	-0.1925	1	STUK
	A			
	A	-0.1991	7	AQUARIUS
	A			
	A	-0.2267	14	SPRUT
	A			
B	A	-0.2404	5	NIEMISTÖ G
B	A			
B	A	-0.3377	2	LIMNOS
B	A			
B	A	-0.4247	4	GEMINI
B	A			
B	A	-0.5062	9	NIEMISTÖ A
B	A			
B	A	-0.6348	5	SMALL BOX
B				
B		-0.7938	3	LARGE BOX

Table IV. Results of Tukey's test, reference "median of total Cs-137 value".

**Reference: Median of total Cs-137 values**

General Linear Models Procedure

Tukey's Studentized Range (HSD) Test for variable: STDtotCs

NOTE: This test controls the type I experimentwise error rate, but generally has a higher type II error rate than REGWQ.

Alpha= 0.05 df= 41 MSE= 0.085126  
 Critical Value of Studentized Range= 4.728  
 Minimum Significant Difference= 0.8513  
 WARNING: Cell sizes are not equal.  
 Harmonic Mean of cell sizes= 2.625547

Means with the same letter are not significantly different.

Tukey Grouping	Mean	N	Corer
A	0.2102	7	AQUARIUS
A			
A	0.1801	14	SPRUT
A			
A	0.1576	5	NIEMISTÖ G
A			
B	0.0409	1	SELENA
B			
B	0.0000	1	STUK
B			
B	-0.0010	2	LIMNOS
B			
B	-0.0152	4	GEMINI
B			
B	-0.2441	9	NIEMISTÖ A
B			
B	-0.4923	5	SMALL BOX
B			
B	-0.7112	3	LARGE BOX



Table V. Results of Tukey's test, reference "nearest to the FIN Niemistö Corer in total Cs-137".

**Reference: Niemistö Corer**

General Linear Models Procedure

Tukey's Studentized Range (HSD) Test for variable: STDtotCs

NOTE: This test controls the type I experimentwise error rate, but generally has a higher type II error rate than REGWQ.

Alpha= 0.05 df= 41 MSE= 0.185159  
 Critical Value of Studentized Range= 4.728  
 Minimum Significant Difference= 1.2556  
 WARNING: Cell sizes are not equal.  
 Harmonic Mean of cell sizes= 2.625547

Means with the same letter are not significantly different.

Tukey Grouping		Mean	N	Corer
	A	0.6244	2	LIMNOS
	A			
B	A	0.6078	7	AQUARIUS
B	A			
B	A	0.5598	14	SPRUT
B	A			
B	A	0.5477	5	NIEMISTÖ G
B	A			
B	A	0.2843	4	GEMINI
B	A			
B	A	0.2228	1	SELENA
B	A			
B	A	0.1747	1	STUK
B	A			
B	A	-0.0429	9	NIEMISTÖ A
B	A			
B	A	-0.3092	5	SMALL BOX
B				
B		-0.6404	3	LARGE BOX

Table VI. Ranking list of different corers at different stations compiled on the basis of the 11 categories (see the text).

Station	1	2	3	4	5	6	7	8	9	10	11
BY-15	Nie G	Nie G	Aqu	Sprut	Sprut	L box	L box	L box	L box	L box	L box
	Gem	Aqu	Nie G	Gem	Gem	S box	S box	S box	S box	S box	S box
	Nie A	Gem	Sprut	Aqu	Aqu	Sprut	Sprut	Nie A	Nie A	Aqu	
EB-1	Nie A	Sprut	Sprut	STUK	Sprut	Sele	S box	S box	S box	Sprut	-
	Sprut	Nie G	Aqu	Nie A	STUK	Sprut	Sprut	L box	L box	S box	-
	Nie G	Nie A	Nie G	Sprut	Sele	-	-	Sprut	Sprut	Aqu	-
Teili-1	Nie A	Sprut	Sprut	Sprut	Gem	Gem	L box	L box	Sprut	Sprut	L box
	Nie G	Nie G	Nie G	Gem	Sprut	L box	S box	S box	L box	Nie G	S box
	Sprut	Gem	-	Aqu	Aqu	Aqu	Aqu	Nie A	S box	L box	
XV-1	Nie A	Limn	Sprut	Limn	Gem	L box	L box	L box	L box	Sprut	L box
	Limn	Sprut	Aqu	S box	Sprut	Sprut	Nie G	Nie A	Nie A	Aqu	
	Gem	-	-	Nie G	Limn	-	Gem	Nie G	Sprut	L box	

**APPENDIX**  
**Analytical data**

## Sampling station: BY-15

**Sampler:** Aquarius Corer FIN (I) Number of cores: 1 Area: 333.1 cm<sup>2</sup> (182x183 mm)

Depth (cm)	Dry wt. (g)	K-40	Cs-134	Cs-137	Pu-238	Pu-239	Pu-238/Pu-239
Bq/kg dry wt.							
0-2	35.0	500	10	200	-	-	-
2-4	52.0	450	0	83	-	-	-
4-6	72.0	750	0	37	-	-	-
6-8	128.0	780	0	16	-	-	-
8-10	144.0	800	0	8.6	-	-	-
10-15	373.0	890	0	3.5	-	-	-
15-20	416.0	930	0	0	-	-	-

**Sampler:** Aquarius Corer FIN (II) Number of cores: 1 Area: 333.1 cm<sup>2</sup> (182x183 mm)

Depth (cm)	Dry wt. (g)	K-40	Cs-134	Cs-137	Pu-238	Pu-239	Pu-238/Pu-239
Bq/kg dry wt.							
0-5	88.0	530	0	130	-	-	-
5-10	242.0	770	0	29	-	-	-
10-15	373.0	880	0	7.1	-	-	-
15-20	419.0	1000	0	0	-	-	-

**Sampler:** Large Box Corer D Number of cores: 2 Area: 138.8 cm<sup>2</sup> (Ø 94 mm), total 500x500

Depth (cm)	Dry wt. (g)	K-40	Cs-134	Cs-137	Pu-238	Pu-239	Pu-238/Pu-239
Bq/kg dry wt.							
0-2	68.2	910	< 4.3	< 2.0	-	-	-
2-4	78.9	930	< 4.1	< 1.7	-	-	-
4-6	75.9	890	< 4.1	< 1.8	-	-	-
6-8	86.2	820	< 3.7	< 1.6	-	-	-
8-10	86.5	800	< 3.3	< 1.5	-	-	-
10-12	81.2	860	< 2.2	< 1.0	-	-	-
12-14	77.9	780	< 2.4	< 1.0	-	-	-
14-16	83.1	720	< 2.6	< 1.2	-	-	-
16-18	70.0	860	< 2.4	< 1.0	-	-	-
18-20	89.4	770	< 1.9	< 1.1	-	-	-

0 = below detection limit

- = not analysed

**Sampler:** Small Box Corer D      Number of cores: 2    Area: 138.8 cm<sup>2</sup> (Ø 94 mm ), total 150x150

Depth (cm)	Dry wt. (g)	K-40	Cs-134	Cs-137	Pu-238	Pu-239	Pu-238/Pu-239
Bq/kg dry wt.							
0-2	58.2	760	<4.0	13	-	-	-
2-4	60.5	920	<3.9	6.0	-	-	-
4-6	64.5	930	<4.4	3.1	-	-	-
6-8	66.7	930	<4.3	<1.9	-	-	-
8-10	69.3	930	<4.3	<1.9	-	-	-
10-12	77.3	920	<3.2	<1.3	-	-	-
12-14	73.0	940	<4.0	<1.7	-	-	-
14-16	76.5	880	<3.1	<1.2	-	-	-
16-18	77.5	960	<2.2	<0.90	-	-	-
18-20	80.4	920	<1.7	<0.70	-	-	-

**Sampler:** Sprut Corer POL      Number of cores: 2    Area: 116.2 cm<sup>2</sup> (Ø 86 mm )

Depth (cm)	Dry wt. (g)	K-40	Cs-134	Cs-137	Pu-238	Pu-239	Pu-238/Pu-239
Bq/kg dry wt.							
0-2	14.2	570	5.4	111	-	-	-
2-4	23.9	660	0.50	73	-	-	-
4-6	50.4	990	0.30	20	-	-	-
6-8	64.3	990	0	6.0	-	-	-
8-10	71.9	1120	0	3.0	-	-	-
10-15	170.6	1110	0	0.6	-	-	-
15-20	176.7	1150	0	0	-	-	-

**Sampler:** Gemini Corer FIN      Number of cores: 2    Area: 100.5 cm<sup>2</sup> (Ø 80 mm )

Depth (cm)	Dry wt. (g)	K-40	Cs-134	Cs-137	Pu-238	Pu-239	Pu-238/Pu-239
Bq/kg dry wt.							
0-2	8.0	480	13	190	-	-	-
2-4	13.0	500	1.5	97	-	-	-
4-6	18.0	580	0	52	-	-	-
6-8	38.0	730	0	16	-	-	-
8-10	40.0	800	0	9.0	-	-	-
10-15	117.0	890	0	4.8	-	-	-
15-20	127.0	960	0	0	-	-	-

0 = below detection limit  
 - = not analysed

**Sampler:** Niemistö Corer FIN      Number of cores: 5    Area: 98.2 cm<sup>2</sup> (Ø 50 mm )

Depth (cm)	Dry wt. (g)	K-40	Cs-134	Cs-137	Pu-238	Pu-239	Pu-238/Pu-239
Bq/kg dry wt.							
0-2	11.0	500	12	160	-	-	-
2-4	18.0	580	0	68	-	-	-
4-6	26.0	680	0	24	-	-	-
6-8	39.0	760	0	10	-	-	-
8-10	43.0	820	0	6.6	-	-	-
10-15	112.0	950	0	0	-	-	-
15-20	119.0	860	0	0	-	-	-

**Sampler:** Niemistö Corer S      Number of cores: 5    Area: 98.2 cm<sup>2</sup> (Ø 50 mm )

Depth (cm)	Dry wt. (g)	K-40	Cs-134	Cs-137	Pu-238	Pu-239	Pu-238/Pu-239
Bq/kg dry wt.							
0-2	8.5	670	10	133	-	-	-
2-4	19.3	780	6.0	40	-	-	-
4-6	31.7	850	0	16	-	-	-
6-8	36.4	560	0	9.7	-	-	-
8-10	41.7	970	0	3.8	-	-	-

**Sampler:** Niemistö Corer D      Number of cores: 3    Area: 68.7 cm<sup>2</sup> (Ø 54 mm )

Depth (cm)	Dry wt. (g)	K-40	Cs-134	Cs-137	Pu-238	Pu-239	Pu-238/Pu-239
Bq/kg dry wt.							
0-2	4.7	650	< 13	207	-	-	-
2-4	9.9	550	< 7.8	102	-	-	-
4-6	16.4	640	< 5.9	49	-	-	-
6-8	28.4	800	< 4.7	19	-	-	-
8-10	31.4	950	< 5.0	11	-	-	-
10-12	32.6	990	< 4.7	7.2	-	-	-
12-14	35.2	1020	< 4.9	3.5	-	-	-
14-16	34.3	1050	< 3.0	2.2	-	-	-
16-18	36.8	1030	< 3.0	1.6	-	-	-
18-20	39.1	1020	< 2.8	1.5	-	-	-

0 = below detection limit  
 - = not analysed

**Sampler:** Sprut Corer RUS (I)    Number of cores: 1    Area: 58.1 cm<sup>2</sup> (Ø 86 mm )

Depth (cm)	Dry wt. (g)	K-40	Cs-134	Cs-137	Pu-238	Pu-239	Pu-238/Pu-239
Bq/kg dry wt.							
0-2	6.6	<3700	<7.0	180	-	-	-
2-4	9.2	<2800	<6.0	88	-	-	-
4-6	17.0	<1800	<6.0	15	-	-	-
6-8	23.1	<1400	<6.0	10	-	-	-
8-10	28.3	<1100	<4.0	<3.0	-	-	-
10-15	75.3	<750	<2.0	5.6	-	-	-
15-20	77.9	<750	<2.0	<1.0	-	-	-

**Sampler:** Sprut Corer RUS (II)    Number of cores: 1    Area: 58.1 cm<sup>2</sup> (Ø 86 mm )

Depth (cm)	Dry wt. (g)	K-40	Cs-134	Cs-137	Pu-238	Pu-239	Pu-238/Pu-239
Bq/kg dry wt.							
0-2	8.5	<3000	<7.0	137	-	-	-
2-4	12.2	<2200	<15	136	-	-	-
4-6	20.3	<1500	<4.0	31	-	-	-
6-8	28.1	<1200	<4.0	4.3	-	-	-
8-10	28.0	<1200	<3.0	<3.0	-	-	-
10-15	75.7	<730	<3.0	<1.0	-	-	-
15-20	75.9	<530	<2.0	<2.0	-	-	-

## Sampling station: Teili-1

**Sampler:** Aquarius Corer FIN (I) Number of cores: 1 Area: 333.1 cm<sup>2</sup> (182x183 mm )

Depth (cm)	Dry wt. (g)	K-40	Cs-134	Cs-137	Pu-238	Pu-239	Pu-238/Pu-239
0-5	229.0	790	16	270	-	-	-
5-10	205.0	800	0	75	-	-	-
10-15	412.0	900	0	12	-	-	-

**Sampler:** Aquarius Corer FIN (II) Number of cores: 1 Area: 333.1 cm<sup>2</sup> (182x183 mm )

Depth (cm)	Dry wt. (g)	K-40	Cs-134	Cs-137	Pu-238	Pu-239	Pu-238/Pu-239
0-5	214.0	750	19	270	-	-	-
5-10	223.0	900	1.4	95	-	-	-
10-15	419.0	1000	0	14	-	-	-

**Sampler:** Large Box Corer D Number of cores: 2 Area: 138.8 cm<sup>2</sup> (94 mm ), total 500x500

Depth (cm)	Dry wt. (g)	K-40	Cs-134	Cs-137	Pu-238	Pu-239	Pu-238/Pu-239
0-2	39.8	840	<5.8	62	-	-	-
2-4	51.3	970	<4.8	26	-	-	-
4-6	68.3	1010	<4.3	9.7	-	-	-
6-8	84.6	1080	<4.1	4.8	-	-	-
8-10	93.4	1070	<2.8	2.3	-	-	-
10-12	98.9	1100	<1.9	1.4	-	-	-
12-14	100.0	1090	<2.6	<1.2	-	-	-
14-16	102.1	1090	<3.1	<1.5	-	-	-
16-18	96.7	1110	<2.2	<1.4	-	-	-
18-20	95.3	1060	<2.2	<0.90	-	-	-

0 = below detection limit

- = not analysed



**Sampler:** Small Box Corer D      Number of cores: 2    Area: 138.8 cm<sup>2</sup> (Ø 94 mm ), total 150x150

Depth (cm)	Dry wt. (g)	K-40	Cs-134	Cs-137	Pu-238	Pu-239	Pu-238/Pu-239
Bq/kg dry wt.							
0-2	37.0	730	<6.6	84	-	-	-
2-4	44.8	930	<5.7	33	-	-	-
4-6	66.3	970	<4.4	10	-	-	-
6-8	80.0	1050	<4.4	5.2	-	-	-
8-10	92.1	1040	<3.9	3.1	-	-	-
10-12	102.2	1090	<2.9	1.6	-	-	-
12-14	100.0	1060	<2.7	<1.2	-	-	-
14-16	102.1	1090	<2.6	<1.1	-	-	-
16-18	103.9	1100	<2.2	<0.90	-	-	-

**Sampler:** Sprut Corer POL (I)      Number of cores: 1    Area: 58.1 cm<sup>2</sup> (Ø 86 mm )

Depth (cm)	Dry wt. (g)	K-40	Cs-134	Cs-137	Pu-238	Pu-239	Pu-238/Pu-239
Bq/kg dry wt.							
0-2	13.2	850	25	397	-	-	-
2-4	17.5	840	23	386	-	-	-
4-6	16.4	560	13	186	-	-	-
6-8	17.4	810	3.0	109	-	-	-
8-10	17.6	560	0	79	-	-	-
10-15	39.8	940	0	53	-	-	-
15-20	87.3	1170	0	5.0	-	-	-

**Sampler:** Sprut Corer POL (II)      Number of cores: 2    Area: 116.2 cm<sup>2</sup> (Ø 86 mm )

Depth (cm)	Dry wt. (g)	K-40	Cs-134	Cs-137	Pu-238	Pu-239	Pu-238/Pu-239
Bq/kg dry wt.							
0-2	29.0	1140	27	545	-	-	-
2-4	29.0	1080	23	512	-	-	-
4-6	35.0	810	16	295	-	-	-
6-8	33.0	1020	0	126	-	-	-
8-10	38.0	950	0	106	-	-	-
10-15	74.0	1080	0	89	-	-	-
15-20	146.0	1580	0	11	-	-	-

0 = below detection limit  
 - = not analysed

**Sampler:** Sprut Corer RUS

Number of cores: 1 Area: 58.1 cm<sup>2</sup> (Ø 86 mm )

Depth (cm)	Dry wt. (g)	K-40	Cs-134	Cs-137	Pu-238	Pu-239	Pu-238/Pu-239
Bq/kg dry wt.							
0-2	14.5	<1900	<26	282	-	-	-
2-4	18.4	<1800	28	257	-	-	-
4-6	18.4	<1600	<7.0	111	-	-	-
6-8	18.0	<1600	<8.0	56	-	-	-
8-10	27.6	<1200	<5.0	8.0	-	-	-
10-15	106.6	<480	<2.0	<1.0	-	-	-
15-20	110.0	<800	<2.0	4.6	-	-	-

**Sampler:** Gemini Corer FIN

Number of cores: 4 Area: 201.1 cm<sup>2</sup> (Ø 80 mm )

Depth (cm)	Dry wt. (g)	K-40	Cs-134	Cs-137	Pu-238	Pu-239	Pu-238/Pu-239
Bq/kg dry wt.							
0-1	24.0	690	22	310	0.28	1.5	0.18
1-2	35.0	820	23	360	0.070	1.3	0.053
2-3	35.0	820	18	280	<0.03	1.3	-
3-4	30.0	830	3.4	130	0.10	1.9	0.052
4-5	26.0	690	0	99	0.17	3.5	0.048
5-6	25.0	810	0	89	0.31	8.7	0.011
6-7	28.0	840	0	51	0.21	9.4	0.022
7-8	42.0	920	0	29	0.19	4.9	0.038
8-9	48.0	950	0	15	<0.02	2.3	-
9-10	56.0	1000	0	10	<0.02	0.50	-
10-15	378.0	980	0	0	<0.02	0.10	-
15-20	369.0	1000	0	0	<0.02	<0.02	-

**Sampler:** Gemini Corer RUS

Number of cores: 1 Area: 50.3 cm<sup>2</sup> (Ø 80 mm )

Depth (cm)	Dry wt. (g)	K-40	Cs-134	Cs-137	Pu-238	Pu-239	Pu-238/Pu-239
Bq/kg dry wt.							
0-2	15.0	<1900	<13	379	-	-	-
2-4	16.0	<1800	<9.0	221	-	-	-
4-6	13.0	<2100	<7.0	117	-	-	-
6-8	22.0	<1400	<6.0	25	-	-	-
8-10	25.0	<1100	<5.0	12	-	-	-
10-15	98.0	<700	<2.0	<1.0	-	-	-
15-20	102.0	<800	<3.0	<1.0	-	-	-

0 = below detection limit

- = not analysed

**Sampler:** Niemistö Corer D

Number of cores: 4 Area: 91.6 cm<sup>2</sup> (Ø 54 mm )

Depth (cm)	Dry wt. (g)	K-40	Cs-134	Cs-137	Pu-238	Pu-239	Pu-238/Pu-239
Bq/kg dry wt.							
0-2	20.6	790	23	393	-	-	-
2-4	26.9	760	22	373	-	-	-
4-6	25.0	670	11	198	-	-	-
6-8	25.3	820	<6.1	108	-	-	-
8-10	24.5	750	<6.0	86	-	-	-
10-12	24.7	870	<6.3	78	-	-	-
12-14	32.4	970	<3.5	40	-	-	-
14-16	45.2	1070	<2.9	14	-	-	-
16-18	59.3	1100	<2.6	5.9	-	-	-
18-20	68.8	1110	<2.4	3.3	-	-	-

**Sampler:** Niemistö Corer FIN (I) Number of cores: 10 Area: 196.3 cm<sup>2</sup> (Ø 50 mm )

Depth (cm)	Dry wt. (g)	K-40	Cs-134	Cs-137	Pu-238	Pu-239	Pu-238/Pu-239
Bq/kg dry wt.							
0-1	18.0	680	22	300	-	-	-
1-2	24.0	720	25	330	-	-	-
2-3	26.0	690	21	300	-	-	-
3-4	24.0	830	6.7	170	-	-	-
4-5	24.0	820	2.9	120	-	-	-
5-6	23.0	800	2.4	87	-	-	-
6-7	30.0	890	0	43	-	-	-
7-8	35.0	900	0	29	-	-	-
8-9	47.0	1100	0	15	-	-	-
9-10	52.0	980	0	7.9	-	-	-
10-15	337.0	970	0	3.5	-	-	-
15-20	355.0	1100	0	0	-	-	-
20-25	370.0	1100	0	0	-	-	-
25-30	384.0	1100	0	0	-	-	-

**Sampler:** Niemistö Corer FIN (II) Number of cores: 5 Area: 98.2 cm<sup>2</sup> (Ø 50 mm )

Depth (cm)	Dry wt. (g)	K-40	Cs-134	Cs-137	Pu-238	Pu-239	Pu-238/Pu-239
Bq/kg dry wt.							
0-2	25.0	840	21	300	-	-	-
2-4	29.0	830	10	210	-	-	-
4-6	28.0	850	0	66	-	-	-
6-8	42.0	950	0	20	-	-	-
8-10	57.0	980	0	8.1	-	-	-
10-15	177.0	1100	0	3.0	-	-	-
15-20	179.0	1000	0	0	-	-	-

0 = below detection limit

- = not analysed

**Sampler:** Niemistö Corer S

Number of cores: 5 Area: 98.2 cm<sup>2</sup> (Ø 50 mm )

<b>Depth (cm)</b>	<b>Dry wt. (g)</b>	<b>K-40</b>	<b>Cs-134</b>	<b>Cs-137</b>	<b>Pu-238</b>	<b>Pu-239</b>	<b>Pu-238/Pu-239</b>
				<b>Bq/kg dry wt.</b>			
0-2	21.7	870	43	373	-	-	-
2-4	24.8	840	12	195	-	-	-
4-6	27.6	770	3.0	63	-	-	-
6-8	42.5	800	2.2	24	-	-	-
8-10	58.8	1110	0	6.2	-	-	-
10-15	171.9	790	0	3.4	-	-	-
15-20	173.6	830	0	1.2	-	-	-

0 = below detection limit

- = not analysed

## Sampling station: XV-1

**Sampler:** Aquarius Corer FIN (I) Number of cores: 1 Area: 333.1 cm<sup>2</sup> (182x183 mm )

Depth (cm)	Dry wt. (g)	K-40	Cs-134	Cs-137	Pu-238	Pu-239	Pu-238/Pu-239
0-5	207.0	850	210	2400	-	-	-
5-10	252.0	860	120	1400	-	-	-
10-15	250.0	790	9.5	190	-	-	-
15-20	282.0	790	6.8	110	-	-	-

**Sampler:** Aquarius Corer FIN (II) Number of cores: 1 Area: 333.1 cm<sup>2</sup> (182x183 mm )

Depth (cm)	Dry wt. (g)	K-40	Cs-134	Cs-137	Pu-238	Pu-239	Pu-238/Pu-239
0-5	210.0	800	170	2100	-	-	-
5-10	251.0	850	200	2300	-	-	-
10-15	228.0	840	14	270	-	-	-
15-20	173.0	840	5.5	150	-	-	-

**Sampler:** Large Box Corer D Number of cores: 2 Area: 138.8 cm<sup>2</sup> (Ø 94 mm ), total 500x500

Depth (cm)	Dry wt. (g)	K-40	Cs-134	Cs-137	Pu-238	Pu-239	Pu-238/Pu-239
0-2	46.2	910	<7.3	113	-	-	-
2-4	48.6	910	<7.0	99	-	-	-
4-6	51.8	910	<6.6	104	-	-	-
6-8	57.4	950	<6.1	99	-	-	-
8-10	57.7	940	<4.9	94	-	-	-
10-12	63.3	960	<4.5	73	-	-	-
12-14	66.4	990	<3.5	44	-	-	-
14-16	64.0	970	<3.2	21	-	-	-
16-18	66.8	960	<2.9	9.2	-	-	-
18-20	68.0	970	<2.6	3.2	-	-	-

0 = below detection limit

- = not analysed

**Sampler:** Small Box Corer D      Number of cores: 2    Area: 138.8 cm<sup>2</sup> (Ø 94 mm ), total 150x150

Depth (cm)	Dry wt. (g)	K-40	Cs-134	Cs-137	Pu-238	Pu-239	Pu-238/Pu-239
Bq/kg dry wt.							
0-2	34.9	920	182	2501	-	-	-
2-4	41.0	910	158	2164	-	-	-
4-6	35.7	870	215	2953	-	-	-
6-8	42.8	920	25	432	-	-	-
8-10	41.8	920	7.5	213	-	-	-
10-12	43.4	920	5.5	163	-	-	-
12-14	44.2	940	4.0	159	-	-	-
14-16	48.0	940	4.6	164	-	-	-

**Sampler:** Limnos Corer FIN (I)      Number of cores: 2    Area: 135.9 cm<sup>2</sup> (Ø 93 mm )

Depth (cm)	Dry wt. (g)	K-40	Cs-134	Cs-137	Pu-238	Pu-239	Pu-238/Pu-239
Bq/kg dry wt.							
0-1	12.0	650	98	1100	0.02	2.0	0
1-2	18.0	770	130	1500	0.18	2.6	0.069
2-3	16.0	660	130	1600	0.13	2.7	0.048
3-4	22.0	830	170	2100	0.14	3.1	0.045
4-5	20.0	810	190	2300	0.090	3.1	0.029
5-6	19.0	840	400	4700	0.29	3.9	0.074
6-7	21.0	780	130	1600	0.12	3.5	0.034
7-8	22.0	860	26	390	0.14	4.0	0.035
8-9	23.0	810	17	290	0.20	4.1	0.048
9-10	23.0	790	12	230	0.090	3.8	0.023
10-15	108.0	910	5.0	140	0	0	0

**Sampler:** Limnos Corer FIN (II)      Number of cores: 1    Area: 67.9 cm<sup>2</sup> (Ø 93 mm )

Depth (cm)	Dry wt. (g)	K-40	Cs-134	Cs-137	Pu-238	Pu-239	Pu-238/Pu-239
Bq/kg dry wt.							
0-2	16.0	740	140	1600	0.13	2.8	0.046
2-4	20.0	780	270	3100	0.090	3.0	0.030
4-6	21.0	800	190	2300	0.16	3.6	0.044
6-8	23.0	740	17	280	0.12	3.8	0.031
8-10	21.0	770	5.4	160	0.13	4.2	0.030
10-15	57.0	830	3.0	120	-	-	-
15-20	63.0	790	2.3	96	-	-	-

0 = below detection limit

- = not analysed

**Sampler:** Sprut Corer POL (I)      Number of cores: 2    Area: 116.2 cm<sup>2</sup> (Ø 86 mm )

Depth (cm)	Dry wt. (g)	K-40	Cs-134	Cs-137	Pu-238	Pu-239	Pu-238/Pu-239
Bq/kg dry wt.							
0-2	34.9	890	187	2126	-	2.8	-
2-4	46.6	940	395	4385	-	3.1	-
4-6	43.9	880	41	599	-	4.1	-
6-8	36.1	960	9.0	195	-	5.0	-
8-10	41.2	870	3.0	122	-	5.5	-
10-12	45.4	860	1.0	98	-	6.0	-
12-14	46.1	850	2.0	102	-	6.3	-
14-16	48.3	890	2.0	99	-	6.5	-
16-18	64.7	910	0.90	96	-	7.3	-
18-20	57.2	900	0	91	-	7.9	-

**Sampler:** Sprut Corer POL (II)      Number of cores: 2    Area: 116.2 cm<sup>2</sup> (Ø 86 mm )

Depth (cm)	Dry wt. (g)	K-40	Cs-134	Cs-137	Pu-238	Pu-239	Pu-238/Pu-239
Bq/kg dry wt.							
0-3	49.9	1120	188	2539	-	-	-
3-6	60.1	1310	286	3693	-	-	-
6-9	64.3	1130	9.1	276	-	-	-
9-12	67.1	1100	1.8	160	-	-	-
12-15	79.1	1180	1.3	139	-	-	-
15-18	87.0	1140	0	129	-	-	-
18-21	98.0	1160	0	100	-	-	-

**Sampler:** Sprut Corer RUS (I)      Number of cores: 1    Area: 58.1 cm<sup>2</sup> (Ø 86 mm )

Depth (cm)	Dry wt. (g)	K-40	Cs-134	Cs-137	Pu-238	Pu-239	Pu-238/Pu-239
Bq/kg dry wt.							
0-2	16.4	<1900	240	2470	0.14	3.5	0.040
2-4	18.6	<1700	337	4620	0.13	4.4	0.029
4-6	16.3	<1900	<12	591	0.17	4.4	0.38
6-8	16.5	<1800	<12	229	0	5.1	-
8-10	22.0	<1500	<6.0	134	0	5.9	-
10-15	52.6	<800	<4.0	113	0	6.8	-
15-20	51.4	<800	<3.0	116	0	8.5	-

0 = below detection limit  
 - = not analysed

**Sampler:** Sprut Corer RUS (II)    Number of cores: 1    Area: 58.1 cm<sup>2</sup> (Ø 86 mm )

Depth (cm)	Dry wt. (g)	K-40	Cs-134	Cs-137	Pu-238	Pu-239	Pu-238/Pu-239
Bq/kg dry wt.							
0-2	16.8	<1800	<100	1820	-	-	-
2-4	28.8	<1100	210	2170	-	-	-
4-6	19.4	<1600	31	383	-	-	-
6-8	17.6	<1700	<6.0	213	-	-	-
8-10	20.8	<1600	<10	136	-	-	-
10-15	50.0	<800	<4.0	110	-	-	-
15-20	60.0	<700	<2.0	96	-	-	-

**Sampler:** Gemini Corer RUS    Number of cores: 1    Area: 50.3 cm<sup>2</sup> (Ø 80 mm )

Depth (cm)	Dry wt. (g)	K-40	Cs-134	Cs-137	Pu-238	Pu-239	Pu-238/Pu-239
Bq/kg dry wt.							
0-2	11.0	<2400	114	1600	-	-	-
2-4	14.0	<2000	120	1840	-	-	-
4-6	16.0	<1800	78	1230	-	-	-
6-8	16.0	<1800	95	1490	-	-	-
8-10	16.0	<1900	15	340	-	-	-
10-15	39.0	<1000	<5.0	144	-	-	-
15-20	42.0	<1000	<5.0	124	-	-	-

**Sampler:** Niemistö Corer D    Number of cores: 4    Area: 91.6 cm<sup>2</sup> (Ø 54 mm )

Depth (cm)	Dry wt. (g)	K-40	Cs-134	Cs-137	Pu-238	Pu-239	Pu-238/Pu-239
Bq/kg dry wt.							
Analysed by BSH (D)							
0-2	22.5	880	128	1729	0.14	2.8	0.049
2-4	31.0	930	104	1422	0.17	3.4	0.048
4-6	32.8	950	101	1403	0.17	3.8	0.044
6-8	32.7	950	127	1694	0.20	4.5	0.044
8-10	35.4	940	52	758	0.14	5.0	0.027
10-12	35.5	920	<6.6	167	0.12	5.4	0.021
12-14	37.6	920	<4.8	117	0.12	5.1	0.023
14-16	38.0	960	<4.6	83	0.090	3.8	0.023
16-18	41.3	980	<4.1	69	-	-	-
18-20	42.0	940	<3.5	57	-	-	-

0 = below detection limit  
 - = not analysed



**Sampler:** Niemistö Corer FIN      Number of cores: 5    Area: 98.2 cm<sup>2</sup> (Ø 50 mm )

Depth (cm)	Dry wt. (g)	K-40	Cs-134	Cs-137	Pu-238	Pu-239	Pu-238/Pu-239
Bq/kg dry wt.							
0-2	24.0	800	170	2100	-	-	-
2-4	28.0	810	120	1500	-	-	-
4-6	29.0	870	89	1100	-	-	-
6-8	30.0	840	6.5	180	-	-	-
8-10	32.0	810	0	110	-	-	-
10-15	79.0	850	0	98	-	-	-
15-20	94.0	-	-	-	-	-	-

**Sampler:** Niemistö Corer S      Number of cores: 5    Area: 98.2 cm<sup>2</sup> (Ø 50 mm )

Depth (cm)	Dry wt. (g)	K-40	Cs-134	Cs-137	Pu-238	Pu-239	Pu-238/Pu-239
Bq/kg dry wt.							
0-2	15.4	950	255	2711	-	-	-
2-4	20.3	700	107	1439	-	-	-
4-6	20.2	900	38	476	-	-	-
6-8	20.3	700	9.0	156	-	-	-
8-10	24.8	980	13	123	-	-	-
10-15	85.1	700	4.0	117	-	-	-
15-20	95.8	740	5.0	109	-	-	-

## Sampling station : EB-1

**Sampler:** Aquarius Corer FIN      Number of cores: 1      Area: 333.1 cm<sup>2</sup> (182x183 mm )

Depth (cm)	Dry wt. (g)	K-40	Cs-134	Cs-137	Pu-238	Pu-239	Pu-238/Pu-239
Bq/kg dry wt.							
0-5	360.0	880	110	1300	-	-	-
5-10	532.0	1000	110	1400	-	-	-
10-15	415.0	1000	57	740	-	-	-

**Sampler:** Small Box Corer D      Number of cores: 2      Area: 138.8 cm<sup>2</sup> (Ø 94 mm ), total 150x150

Depth (cm)	Dry wt. (g)	K-40	Cs-134	Cs-137	Pu-238	Pu-239	Pu-238/Pu-239
Bq/kg dry wt.							
Analysed by BSH (D)							
0-2	64.5	990	120	1585	0.20	3.3	0.060
2-4	78.7	950	113	1483	0.12	3.6	0.033
4-6	92.2	1010	51	737	0.25	4.4	0.056
6-8	93.9	1030	7.7	176	0.14	4.6	0.030
8-10	98.1	1030	<3.4	96	0.20	5.6	0.035
10-12	98.4	1060	<3.5	69	0.13	4.6	0.028
12-14	101.8	1050	<3.4	46	0.11	3.0	0.036
14-16	102.3	1030	<2.4	24	0.02	1.4	0.050
16-18	104.7	1050	<2.0	12	0	0	-
18-20	102.8	1040	<2.0	7.4	0	0	-

**Sampler:** Large Box Corer D      Number of cores: 2      Area: 138.8 cm<sup>2</sup> (Ø 94 mm ), total 500x500

Depth (cm)	Dry wt. (g)	K-40	Cs-134	Cs-137	Pu-238	Pu-239	Pu-238/Pu-239
Bq/kg dry wt.							
0-2	67.7	980	118	1552	-	-	-
2-4	76.4	1010	111	1509	-	-	-
4-6	91.6	1060	41	608	-	-	-
6-8	96.9	1070	4.3	132	-	-	-
8-10	100.0	1070	<3.3	72	-	-	-
10-12	102.2	1100	<2.6	22	-	-	-
12-14	112.6	1110	<1.9	13	-	-	-
14-16	113.2	1100	<2.1	9.0	-	-	-
16-18	117.6	1090	<2.0	6.0	-	-	-
18-20	115.9	1070	<2.1	5.6	-	-	-

0 = below detection limit

- = not analysed

**Sampler:** Selena Corer FIN

Number of cores: 2 Area: 157.1 cm<sup>2</sup> (Ø 100 mm )

Depth (cm)	Dry wt. (g)	K-40	Cs-134	Cs-137	Pu-238	Pu-239	Pu-238/Pu-239
Bq/kg dry wt.							
0-2	90.0	960	120	1400	-	-	-
2-4	99.0	880	110	1300	-	-	-
4-6	108.0	970	97	1200	-	-	-
6-8	112.0	990	60	800	-	-	-
8-10	122.0	790	49	630	-	-	-
10-15	290.0	970	0	150	-	-	-
15-20	305.0	1000	0	73	-	-	-

**Sampler:** Sprut Corer POL (I)

Number of cores: 2 Area: 116.2 cm<sup>2</sup> (Ø 86 mm )

Depth (cm)	Dry wt. (g)	K-40	Cs-134	Cs-137	Pu-238	Pu-239	Pu-238/Pu-239
Bq/kg dry wt.							
0-2	60.1	1080	114	1425	-	2.6	-
2-4	77.6	1020	124	1392	-	2.9	-
4-6	81.3	1070	94	1157	-	3.0	-
6-8	97.8	1150	16	252	-	3.8	-
8-10	89.1	1100	2.0	94	-	4.4	-
10-12	84.5	1180	0	67	-	4.0	-
12-14	95.0	1180	0	44	-	2.8	-
14-16	92.8	1170	0	26	-	1.5	-
16-18	92.7	1160	0	7.0	-	0.50	-
18-20	95.8	1170	0	6.0	-	0.03	-

**Sampler:** Sprut Corer POL (II)

Number of cores: 2 Area: 116.2 cm<sup>2</sup> (Ø 86 mm )

Depth (cm)	Dry wt. (g)	K-40	Cs-134	Cs-137	Pu-238	Pu-239	Pu-238/Pu-239
Bq/kg dry wt.							
0-3	85.8	980	105	1210	-	-	-
3-6	114.0	900	95	1220	-	-	-
6-9	113.7	1020	41	541	-	-	-
9-12	129.7	1020	2.0	80	-	-	-
12-15	131.0	1010	2.9	61	-	-	-
15-18	135.1	1020	3.4	28	-	-	-
18-21	134.8	1010	2.5	8.3	-	-	-

0 = below detection limit

- = not analysed

**Sampler:** Sprut Corer RUS (I)      Number of cores: 1    Area: 58.1 cm<sup>2</sup> (Ø 86 mm )

Depth (cm)	Dry wt. (g)	K-40	Cs-134	Cs-137	Pu-238	Pu-239	Pu-238/Pu-239
Bq/kg dry wt.							
0-2	23.2	<1400	110	1580	0	3.0	-
2-4	27.8	<1300	93	1510	0	3.3	-
4-6	29.2	<1200	98	1550	0	3.2	-
6-8	37.9	<900	85	1210	0	3.5	-
8-10	33.9	<1200	<70	939	0	3.5	-
10-15	100.0	<900	<4.0	146	0	4.4	-
15-20	100.0	<720	<2.0	76	0	4.6	-

**Sampler:** Sprut Corer RUS (II)      Number of cores: 1    Area: 58.1 cm<sup>2</sup> (Ø 86 mm )

Depth (cm)	Dry wt. (g)	K-40	Cs-134	Cs-137	Pu-238	Pu-239	Pu-238/Pu-239
Bq/kg dry wt.							
0-2	29.2	<1200	110	1750	-	-	-
2-4	27.4	<1300	85	1440	-	-	-
4-6	29.8	<1200	92	1490	-	-	-
6-8	31.8	<1200	81	1410	-	-	-
8-10	41.1	<900	85	1170	-	-	-
10-15	111.0	<700	15	309	-	-	-
15-20	103.0	<700	<3.0	88	-	-	-

**Sampler:** STUK Corer FIN      Number of cores: 3    Area: 96.5 cm<sup>2</sup> (Ø 64 mm )

Depth (cm)	Dry wt. (g)	K-40	Cs-134	Cs-137	Pu-238	Pu-239	Pu-238/Pu-239
Bq/kg dry wt.							
0-2	42.0	890	110	1300	0.12	2.8	0.042
2-4	59.0	900	120	1500	0.13	3.1	0.041
4-6	63.0	940	110	1400	0.13	3.1	0.041
6-8	68.0	1000	78	1000	0.16	3.2	0.050
8-10	67.0	970	31	460	0.18	3.3	0.054
10-15	172.0	1000	3.2	120	0.19	6.6	0.028
15-20	173.0	1100	0	76	0.19	4.3	0.044

0 = below detection limit  
 - = not analysed

**Sampler:** Niemistö Corer D

Number of cores: Area: 91.6 cm<sup>2</sup> (Ø 54 mm )

Depth (cm)	Dry wt. (g)	K-40	Cs-134	Cs-137	Pu-238	Pu-239	Pu-238/Pu-239
Bq/kg dry wt.							
0-2	38.6	930	122	1699	-	-	-
2-4	51.7	990	117	1661	-	-	-
4-6	59.5	980	121	1696	-	-	-
6-8	64.9	980	83	1210	-	-	-
8-10	72.4	1050	11	217	-	-	-
10-12	71.6	1080	<2.0	104	-	-	-
12-14	74.1	1090	<2.2	86	-	-	-
14-16	75.3	1110	<1.5	57	-	-	-
16-18	75.9	1090	<1.8	19	-	-	-
18-20	77.1	1100	<1.7	8.4	-	-	-

**Sampler:** Niemistö Corer FIN

Number of cores: 5 Area: 98.2 cm<sup>2</sup> (Ø 50 mm )

Depth (cm)	Dry wt. (g)	K-40	Cs-134	Cs-137	Pu-238	Pu-239	Pu-238/Pu-239
Bq/kg dry wt.							
0-2	43.0	870	120	1400	-	-	-
2-4	52.0	920	120	1400	-	-	-
4-6	57.0	920	100	1300	-	-	-
6-8	64.0	930	71	900	-	-	-
8-10	70.0	990	26	380	-	-	-
10-15	166.0	1100	0	95	-	-	-
15-20	175.0	950	0	46	-	-	-

**Sampler:** Niemistö Corer S

Number of cores: 5 Area: 98.2 cm<sup>2</sup> (Ø 50 mm )

Depth (cm)	Dry wt. (g)	K-40	Cs-134	Cs-137	Pu-238	Pu-239	Pu-238/Pu-239
Bq/kg dry wt.							
0-2	38.6	1210	173	1652	-	-	-
2-4	47.5	870	121	1626	-	-	-
4-6	54.5	910	142	1588	-	-	-
6-8	59.9	830	126	1476	-	-	-
8-10	59.4	780	77	1003	-	-	-

0 = below detection limit

- = not analysed

## BALTIC SEA ENVIRONMENT PROCEEDINGS

- No. 1 JOINT ACTIVITIES OF THE BALTIC SEA STATES WITHIN THE FRAMEWORK OF THE CONVENTION ON THE PROTECTION OF THE MARINE ENVIRONMENT OF THE BALTIC SEA AREA 1974-1978 (1979)\*
- No. 2 REPORT OF THE INTERIM COMMISSION (IC) TO THE BALTIC MARINE ENVIRONMENT PROTECTION COMMISSION (1981)\*
- No. 3 ACTIVITIES OF THE COMMISSION 1980  
- Report on the activities of the Baltic Marine Environment Protection Commission during 1980  
- HELCOM Recommendations passed during 1980 (1981)\*
- No. 4 BALTIC MARINE ENVIRONMENT BIBLIOGRAPHY 1970-1979 (1981)\*
- No. 5A ASSESSMENT OF THE EFFECTS OF POLLUTION ON THE NATURAL RESOURCES OF THE BALTIC SEA, 1980  
PART A-1: OVERALL CONCLUSIONS (1981)\*
- No. 5B ASSESSMENT OF THE EFFECTS OF POLLUTION ON THE NATURAL RESOURCES OF THE BALTIC SEA, 1980  
PART A-1: OVERALL CONCLUSIONS  
PART A-2: SUMMARY OF RESULTS  
PART B: SCIENTIFIC MATERIAL (1981)
- No. 6 WORKSHOP ON THE ANALYSIS OF HYDROCARBONS IN SEAWATER  
Institut für Meereskunde an der Universität Kiel, Department of Marine Chemistry, March 23 -April 3, 1981 (1982)
- No. 7 ACTIVITIES OF THE COMMISSION 1981  
- Report of the activities of the Baltic Marine Environment Protection Commission during 1981 including the Third Meeting of the Commission held in Helsinki 16-19 February 1982  
- HELCOM Recommendations passed during 1981 and 1982 (1982)
- No. 8 ACTIVITIES OF THE COMMISSION 1982  
- Report of the activities of the Baltic Marine Environment Protection Commission during 1982 including the Fourth Meeting of the Commission held in Helsinki 1-3 February 1983  
- HELCOM Recommendations passed during 1982 and 1983 (1983)
- No. 9 SECOND BIOLOGICAL INTERCALIBRATION WORKSHOP  
Marine Pollution Laboratory and Marine Division of the National Agency of Environmental Protection, Denmark, August 17-20, 1982, Rønne, Denmark (1983)
- No. 10 TEN YEARS AFTER THE SIGNING OF THE HELSINKI CONVENTION  
National Statements by the Contracting Parties on the Achievements in Implementing the Goals of the Convention on the Protection of the Marine Environment of the Baltic Sea

\*) out of print

\*\*) in print

- Area (1984)
- No. 11 STUDIES ON SHIP CASUALTIES IN THE BALTIC SEA 1979-1981  
Helsinki University of Technology, Ship Hydrodynamics Laboratory, Otaniemi, Finland  
P. Tuovinen, V. Kostilainen and A. Hämäläinen  
(1984)
- No. 12 GUIDELINES FOR THE BALTIC MONITORING PROGRAMME FOR THE SECOND  
STAGE  
(1984)\*
- No. 13 ACTIVITIES OF THE COMMISSION 1983  
- Report of the activities of the Baltic Marine Environment Protection Commission during  
1983 including the Fifth Meeting of the Commission held in Helsinki 13-16 March 1984  
- HELCOM Recommendations passed during 1983 and 1984  
(1984)
- No. 14 SEMINAR ON REVIEW OF PROGRESS MADE IN WATER PROTECTION MEASURES  
17-21 October 1983, Espoo, Finland  
(1985)
- No. 15 ACTIVITIES OF THE COMMISSION 1984  
- Report of the activities of the Baltic Marine Environment Protection Commission during  
1984 including the Sixth Meeting of the Commission held in Helsinki 12-15 March 1985  
- HELCOM Recommendations passed during 1984 and 1985  
(1985)
- No. 16 WATER BALANCE OF THE BALTIC SEA  
A Regional Cooperation Project of the Baltic Sea States;  
International Summary Report  
(1986)
- No. 17A FIRST PERIODIC ASSESSMENT OF THE STATE OF THE MARINE ENVIRONMENT OF  
THE BALTIC SEA AREA, 1980-1985; GENERAL CONCLUSIONS  
(1986)
- No. 17B FIRST PERIODIC ASSESSMENT OF THE STATE OF THE MARINE ENVIRONMENT OF  
THE BALTIC SEA AREA, 1980-1985; BACKGROUND DOCUMENT  
(1987)
- No. 18 ACTIVITIES OF THE COMMISSION 1985  
- Report of the activities of the Baltic Marine Environment Protection Commission during  
1985 including the Seventh Meeting of the Commission held in Helsinki 11-14 February  
1986  
- HELCOM Recommendations passed during 1986  
(1986)\*
- No. 19 BALTIC SEA MONITORING SYMPOSIUM  
Tallinn, USSR, 10-15 March 1986  
(1986)
- No. 20 FIRST BALTIC SEA POLLUTION LOAD COMPILATION  
(1987)
- No. 21 SEMINAR ON REGULATIONS CONTAINED IN ANNEX II OF MARPOL 73/78 AND  
REGULATION 5 OF ANNEX IV OF THE HELSINKI CONVENTION  
National Swedish Administration of Shipping and Navigation;  
17-18 November 1986, Norrköping, Sweden  
(1987)

\*) out of print

\*\*) in print

- No. 22 SEMINAR ON OIL POLLUTION QUESTIONS  
19-20 November 1986, Norrköping, Sweden  
(1987)
- No. 23 ACTIVITIES OF THE COMMISSION 1986  
- Report on the activities of the Baltic Marine Environment Protection Commission during 1986 including the Eighth Meeting of the Commission held in Helsinki 24-27 February 1987  
- HELCOM Recommendations passed during 1987  
(1987)\*
- No. 24 PROGRESS REPORTS ON CADMIUM, MERCURY, COPPER AND ZINC  
(1987)
- No. 25 SEMINAR ON WASTEWATER TREATMENT IN URBAN AREAS  
7-9 September 1986, Visby, Sweden  
(1987)
- No. 26 ACTIVITIES OF THE COMMISSION 1987  
- Report on the activities of the Baltic Marine Environment Protection Commission during 1987 including the Ninth Meeting of the Commission held in Helsinki 15-19 February 1988  
- HELCOM Recommendations passed during 1988  
(1988)
- No. 27A GUIDELINES FOR THE BALTIC MONITORING PROGRAMME FOR THE THIRD STAGE;  
PART A. INTRODUCTORY CHAPTERS  
(1988)
- No. 27B GUIDELINES FOR THE BALTIC MONITORING PROGRAMME FOR THE THIRD STAGE;  
PART B. PHYSICAL AND CHEMICAL DETERMINANDS IN SEA WATER  
(1988)
- No. 27C GUIDELINES FOR THE BALTIC MONITORING PROGRAMME FOR THE THIRD STAGE;  
PART C. HARMFUL SUBSTANCES IN BIOTA AND SEDIMENTS  
(1988)
- No. 27D GUIDELINES FOR THE BALTIC MONITORING PROGRAMME FOR THE THIRD STAGE;  
PART D. BIOLOGICAL DETERMINANDS  
(1988)
- No. 28 RECEPTION OF WASTES FROM SHIPS IN THE BALTIC SEA AREA  
- A MARPOL 73/78 SPECIAL AREA  
(1989)
- No. 29 ACTIVITIES OF THE COMMISSION 1988  
- Report on the activities of the Baltic Marine Environment Protection Commission during 1988 including the Tenth Meeting of the Commission held in Helsinki 14-17 February 1989  
- HELCOM Recommendations passed during 1989  
(1989)
- No. 30 SECOND SEMINAR ON WASTEWATER TREATMENT IN URBAN AREAS  
6-8 September 1987, Visby, Sweden  
(1989)
- No. 31 THREE YEARS OBSERVATIONS OF THE LEVELS OF SOME RADIONUCLIDES IN THE  
BALTIC SEA AFTER THE CHERNOBYL ACCIDENT  
Seminar on Radionuclides in the Baltic Sea  
29 May 1989, Rostock-Warnemünde, German Democratic Republic  
(1989)

\*) out of print

\*\*) in print



- No. 32 DEPOSITION OF AIRBORNE POLLUTANTS TO THE BALTIC SEA AREA 1983-1985 AND 1986 (1989)
- No. 33 ACTIVITIES OF THE COMMISSION 1989  
 - Report on the activities of the Baltic Marine Environment Protection Commission during 1989 including the Eleventh Meeting of the Commission held in Helsinki 13-16 February 1990  
 - HELCOM Recommendations passed during 1990 (1990)\*
- No. 34 STUDY OF THE RISK FOR ACCIDENTS AND THE RELATED ENVIRONMENTAL HAZARDS FROM THE TRANSPORTATION OF CHEMICALS BY TANKERS IN THE BALTIC SEA AREA (1990)
- No. 35A SECOND PERIODIC ASSESSMENT OF THE STATE OF THE MARINE ENVIRONMENT OF THE BALTIC SEA, 1984-1988; GENERAL CONCLUSIONS (1990)
- No. 35B SECOND PERIODIC ASSESSMENT OF THE STATE OF THE MARINE ENVIRONMENT OF THE BALTIC SEA, 1984-1988; BACKGROUND DOCUMENT (1990)
- No. 36 SEMINAR ON NUTRIENTS REMOVAL FROM MUNICIPAL WASTE WATER 4-6 September 1989, Tampere, Finland (1990)
- No. 37 ACTIVITIES OF THE COMMISSION 1990  
 - Report on the activities of the Baltic Marine Environment Protection Commission during 1990 including the Twelfth Meeting of the Commission held in Helsinki 19-22 February 1991  
 - HELCOM Recommendations passed during 1991 (1991)
- No. 38 THIRD BIOLOGICAL INTERCALIBRATION WORKSHOP 27-31 August 1990, Visby, Sweden (1991)
- No. 39 AIRBORNE POLLUTION LOAD TO THE BALTIC SEA 1986-1990 (1991)
- No. 40 INTERIM REPORT ON THE STATE OF THE COASTAL WATERS OF THE BALTIC SEA (1991)
- No. 41 INTERCALIBRATIONS AND INTERCOMPARISONS OF MEASUREMENT METHODS FOR AIRBORNE POLLUTANTS (1992)
- No. 42 ACTIVITIES OF THE COMMISSION 1991  
 - Report of the activities of the Baltic Marine Environment Protection Commission during 1991 including the 13th meeting of the Commission held in Helsinki 3-7 February 1992  
 - HELCOM Recommendations passed during 1992 (1992)
- No. 43 BALTIC MARINE ENVIRONMENT BIBLIOGRAPHY 1986-1990 (1992)
- No. 44 NITROGEN AND AGRICULTURE, INTERNATIONAL WORKSHOP 9-12 April 1991, Schleswig, Germany (1993)

\*) out of print

\*\*) in print

- No. 45 SECOND BALTIC SEA POLLUTION LOAD COMPILATION  
(1993)
- No. 46 SUMMARIES OF THE PRE-FEASIBILITY STUDIES  
Prepared for the Baltic Sea Joint Comprehensive Environmental Action Programme  
(1993)\*
- No. 47 HIGH LEVEL CONFERENCE ON RESOURCE MOBILIZATION  
Gdansk, Poland, 24-25 March 1993  
Compilation of Presentations and Statements  
(1993)
- No. 48 THE BALTIC SEA JOINT COMPREHENSIVE ENVIRONMENTAL ACTION PROGRAMME  
(1993)
- No. 49 THE BALTIC SEA JOINT COMPREHENSIVE ENVIRONMENTAL ACTION PROGRAMME  
Opportunities and Constraints in Programme Implementation  
(1993)
- No. 50 SEMINAR ON RECEPTION FACILITIES IN PORTS  
Turku, Finland, 16-19 November 1992  
(1993)
- No. 51 STUDY OF THE TRANSPORTATION OF PACKAGED DANGEROUS GOODS BY SEA  
IN THE BALTIC SEA AREA AND RELATED ENVIRONMENTAL HAZARDS  
(1993)
- No. 52 ACTIVITIES OF THE COMMISSION 1992  
- Report on the activities of the Baltic Marine Environment Protection Commission during  
1992 including the 14th meeting of the Commission held in Helsinki 2-5 February 1993  
- HELCOM Recommendations passed during 1993  
(1993)
- No. 53 BALTIC MARINE ENVIRONMENT BIBLIOGRAPHY 1991-1992  
(1993)
- No. 54 FIRST ASSESSMENT OF THE STATE OF THE COASTAL WATERS OF THE BALTIC  
SEA  
(1993)
- No. 55 ACTIVITIES OF THE COMMISSION 1993  
- Report on the activities of the Baltic Marine Environment Protection Commission during  
1993 including the 15th meeting of the Commission held in Helsinki 8-11 March 1994  
- HELCOM Recommendations passed during 1994  
(1994)
- No. 56 INTERGOVERNMENTAL ACTIVITIES IN THE FRAMEWORK OF THE HELSINKI  
CONVENTION 1974-1994  
(1994)
- No. 57 GUIDELINES FOR THE THIRD POLLUTION LOAD COMPILATION (PLC-3)  
(1994)\*
- No. 58 ICES/HELCOM WORKSHOP ON QUALITY ASSURANCE OF CHEMICAL ANALYTICAL  
PROCEDURES FOR THE BALTIC MONITORING PROGRAMME  
5-8 October 1993, Hamburg, Germany  
(1994)

\*) out of print

\*\*) in print

- No. 59 HELCOM SEMINAR FOR EXPERTS FROM ESTONIA, LATVIA, LITHUANIA AND RUSSIA ON THE IMPLEMENTATION OF HELCOM ARRANGEMENTS, OTHER INTERNATIONAL INSTRUMENTS AND RELATED MATTERS  
30 August - 3 September 1993, Riga, Latvia  
(1994)
- No. 60 ACTIVITIES OF THE COMMISSION 1994  
- Report on the activities of the Baltic Marine Environment Protection Commission during 1994 including the 16th meeting of the Commission held in Helsinki 14-17 March 1995  
- HELCOM Recommendations passed during 1995  
(1995)
- No. 61 RADIOACTIVITY IN THE BALTIC SEA 1984 - 1991  
(1995)
- No. 62 ACTIVITIES OF THE COMMISSION 1995  
- Report on the activities of the Baltic Marine Environment Protection Commission during 1995 including the 17th meeting of the Commission held in Helsinki 12-14 March 1996  
- HELCOM Recommendations passed during 1996  
(1996)
- No. 63 COASTAL AND MARINE PROTECTED AREAS IN THE BALTIC SEA REGION  
(1996)\*
- No. 64A THIRD PERIODIC ASSESSMENT OF THE STATE OF THE MARINE ENVIRONMENT OF THE BALTIC SEA, 1989-1993; EXECUTIVE SUMMARY  
(1996)
- No. 64B THIRD PERIODIC ASSESSMENT OF THE STATE OF THE MARINE ENVIRONMENT OF THE BALTIC SEA, 1989-1993; BACKGROUND DOCUMENT  
(1996)
- No. 65 OVERVIEW ON ACTIVITIES 1996  
(1997)\*
- No. 66 BALTIC MARINE ENVIRONMENT BIBLIOGRAPHY 1993-1995  
(1997)
- No. 67 WORKSHOP ON THE REDUCTION OF EMISSIONS FROM TRAFFIC IN THE BALTIC SEA AREA  
(1997)
- No. 68 THE EVALUATION OF THE RELATION OF ATMOSPHERIC DEPOSITION TO RIVERINE INPUT OF NITROGEN TO THE BALTIC SEA  
(1997)
- No. 69 AIRBORNE POLLUTION LOAD TO THE BALTIC SEA 1991-1995  
(1997)
- No. 70 THE THIRD BALTIC SEA POLLUTION LOAD COMPILATION  
(1998)
- No. 71 THE FINAL REPORT ON THE IMPLEMENTATION OF THE 1988 MINISTERIAL DECLARATION  
(1998)\*
- No. 72 THE BALTIC SEA JOINT COMPREHENSIVE ENVIRONMENTAL ACTION PROGRAMME: RECOMMENDATIONS FOR UPDATING AND STRENGTHENING  
(1998)

\*) out of print

\*\*) in print

- No. 73 OVERVIEW ON ACTIVITIES 1997  
(1998)
- No. 74 AGENDA 21 FOR THE BALTIC SEA REGION, SUSTAINABLE DEVELOPMENT OF THE  
AGRICULTURAL SECTOR IN THE BALTIC SEA REGION  
(1998)
- No. 75 RED LIST OF MARINE AND COASTAL BIOTOPES AND BIOTOPE COMPLEXES OF  
THE BALTIC SEA, BELT SEA AND KATTEGAT  
(1998)
- No. 76 MARINE SEDIMENT EXTRACTION IN THE BALTIC SEA - STATUS REPORT  
(1999)
- No. 77 BALTIC LEGAL MANUAL - INFORMATION ON ANTI-POLLUTION REGULATIONS  
AT SEA AND THE PROSECUTION OF VIOLATIONS THEREOF IN THE BALTIC SEA  
AREA  
(2000)
- No. 78 GUIDELINES ON ENSURING SUCCESSFUL CONVICTIONS OF OFFENDERS OF  
ANTI-POLLUTION REGULATIONS AT SEA  
(2000)
- No. 79 TRANSPORT SECTOR INVESTMENT DECISION-MAKING IN THE BALTIC SEA  
REGION  
(2000)\*\*

\*) out of print

\*\*) in print