

FIRST ASSESSMENT OF THE STATE OF
THE COASTAL WATERS OF THE BALTIC SEA

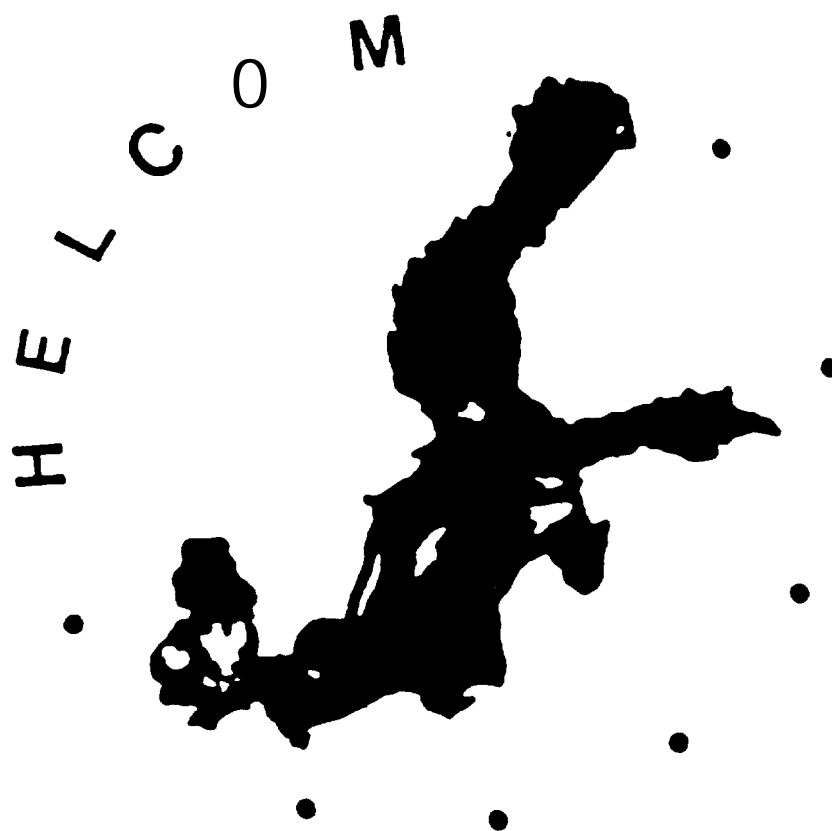

BALTIC SEA ENVIRONMENT PROCEEDINGS

No. 54

FIRST ASSESSMENT OF THE STATE OF
THE COASTAL WATERS OF THE BALTIC SEA

HELSINKI COMMISSION
Baltic Marine Environment Protection Commission
1993

For bibliographic purposes this document should be cited as:

HELCOM, 1993
First Assessment of the State of the Coastal Waters
of the Baltic Sea,
Balt. Sea Environ. Proc. No. 54

Information included in this publication or extracts thereof
is free for citing on the condition that the complete
reference of the publication is given as stated above

Copyright 1993 by the Baltic Marine Environment
Protection Commission - Helsinki Commission -

ISSN 0357-2994

Helsinki - Painatuskeskus Oy

FIRST ASSESSMENT OF THE STATE OF THE COASTAL WATERS OF THE BALTIC SEA

TABLE OF CONTENTS		Page
	PREFACE	1
1.	INTRODUCTION	3
2.	GENERAL FEATURES OF THE COASTAL ZONE	4
	References	12
3.	TROPHIC CONDITIONS AND EFFECTS	13
3.1.	Eutrophication	13
3.1.1.	Background	13
3.1.2.	Regional pattern	14
3.1.3.	Limiting nutrients	31
3.2.	Some secondary effects	34
3.2.1.	Light climate	34
3.2.2.	Benthic vegetation	38
3.2.3.	Toxic blooms	45
	References	48
4.	HAZARDOUS SUBSTANCES	54
4.1.	Metals	54
4.1.1.	Sea water	54
4.1.2.	Sediments	59
4.1.3.	Biota	64
4.2.	Organic compounds	75
4.2.1.	Petroleum hydrocarbons	76
4.2.2.	DDTs and PCBs	80
4.2.2.1.	Trends over time	80
4.2.2.2.	Regional pattern	82
4.2.2.3.	Species pattern	87
4.2.2.4.	Seasonal pattern	91
4.2.3.	Specific items	94
4.2.3.1.	Experiences from local sources	94
4.2.3.2.	Polychlorinated dibenzo-p-dioxins and dibenzofurans (PCDD/PCDF) and planar PCB in organisms from the Baltic Sea	95
4.2.3.3.	Halogenated compounds in coastal sediments	104
	References	110
5.	RECREATION	118
5.1.	Fish and fishery	118
5.2.	Sanitary conditions and bathing	132
5.3.	Boats and boating	137
	References	140

6.	CONCLUSIONS	143
Annex:	Map indicating the geographical location of most of the places mentioned in the report	153
	Baltic Sea Environment Proceedings	156

PREFACE

Within the framework of the Baltic Marine Environment Protection Commission - Helsinki Commission - the First Assessment of the State of the Coastal Waters of the Baltic Sea has been prepared on the basis of the national reports and additional data submitted by all Contracting Parties.

The report has been prepared by an ad hoc Working Group on Coastal Assessment with Sweden acting as lead country and consisting of the following national contact persons:

Ulf Grim&s (Convener)

Swedish Environmental Protection Agency, Sweden

Jørn Kirkegaard

Danish Environmental Protection Agency, Denmark

Eva Lise **Bendixen**

Danish Environmental Protection Agency, Denmark

Villu Astok

Tallinn Technical University,
Institute of Environmental Protection Technology, Estonia

Pentti Kangas

National Board of Waters and the Environment, Finland

Joachim Voss

Landesamt für Wasserhaushalt und **Küsten** Schleswig-Holstein, Germany

Mintauts **Jansons**

Marine Monitoring Centre,
Latvian Hydrometeorological Agency, Latvia

Martins Belickis

Environmental Protection Committee of the Republic of Latvia, Analytical and Information Centre, Latvia

Algirdas Stankevicius

Lithuanian Sea Research Laboratory,
Environmental Protection Department, Lithuania

Anna Trzosinska

Institute of Meteorology and Water Management, Poland

Eugeniusz Andrulowicz

Institute of Meteorology and Water Management, Poland

Semen Y. Oradovsky

State Oceanographic Institute, Russia

In addition separate contributions were received as follows:

Chapter 4.2.3.2. Polychlorinated dibenzo-P-dioxins and dibenzofurans (PCDD/PCDF) and planar PCB in organisms from the Baltic Sea;

Cynthia de Wit

. Institute of Applied Environmental Research,
Stockholm University, Sweden

Chapter 4.2.3.3. Halogenated compounds in coastal sediments;

Per Jonsson

Swedish Environmental Protection Agency, Sweden

The draft version of this report has been considered and amended by relevant experts in the Contracting Parties prior to release. The convener and the members of the group are responsible for the text of this publication. In the Helsinki Commission Secretariat the work has been coordinated by the Environment Secretary, **Eeva-Liisa** Poutanen and the assistant, Teija-Liisa Lehtinen.

1. INTRODUCTION

In accordance with decisions reached by member states of the Commission, national coastal assessments should have been provided by each Baltic Sea State every fifth year starting in 1984. Due to low activity in this matter the tenth meeting of the Commission (1989) adopted HELCOM Recommendation **10/2** concerning assessment on the effects of pollution on the coastal areas of the Baltic Sea, presuming that finalized documents would be available for the use of the Commission meeting in 1993.

Due to the importance of the coastal assessment the eleventh meeting of the Commission, however, urged the Contracting Parties to fulfil the task without delay and submit their contributions to the coastal assessment earlier than that deadline. Taking into account the changes of the political situation in the former USSR during the preparation and the difficulties arising thereby in availability of data from many coastal areas of the Baltic, an interim report was published in 1992 on the state of the coastal waters of the Baltic Sea, prepared by an ad hoc working group under convenership of Ulf Grim& and based on national contributions. A more complete description could be attained by an extension of efforts by one year to reach a more comprehensive final report. Such a report was presented at the fourth meeting of the Environment Committee in 1993 and was recommended for publication.

The main conclusions drawn in the interim report of problem areas are still valid. It should be kept in mind, however, that information delivered is not emerging from harmonized monitoring activities around the Baltic Sea but from different national and heterogenous programmes. There is, nonetheless, a substantial increase of data of importance for the understanding of present conditions and trends over time along the Baltic coasts, to be of use in the second step of actions taken, e.g. towards a common monitoring programme.

A map indicating the geographical location of most of the places mentioned in this report is given in the Annex.

2. GENERAL FEATURES OF THE COASTAL ZONE

There is a wide variety of coastal systems found in the Baltic. Rocky shores dominate in the northern part, e.g. in the Gulf of Bothnia and southwards along the Swedish coast. Archipelagoes of various geographical extents are found mainly in the Gulf of Bothnia and along the Swedish east coast. The largest one covers the area east of Stockholm in a belt extending over Åland into the large Archipelago Sea of Finland and further along the northern coast of the Gulf of Finland. Open shallow and sandy shores are often found in the south-eastern part of the Baltic Proper and around Denmark. Characteristic lagoons (“Haffens”) and shallow, semi-enclosed bays (“Boddens”) occur in the southern part of the Baltic. A classification of the coasts is given in Figure 1 which is a large-scale picture given by Håkanson (1993).

Figure 1. Generalized picture for coast types in the Baltic (redrawn from Voipio (1981) Håkanson (1993)).

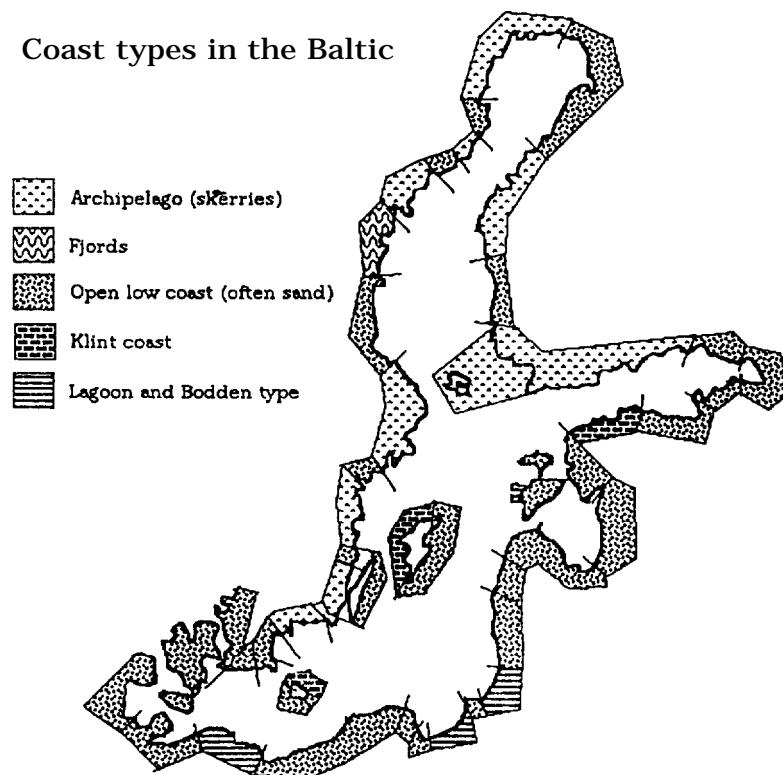

The residence time of water in the various basins is important for the fate of various elements and their effects; being about 3 years in the Bothnian Bay, 6 years in the Bothnian Sea, about 25-30 years in the Baltic Proper, and just a few months in the Kattegat. The residence time of water has, of course, an effect on the retention and potential recirculation of various elements within the main basins, the net transport between the basins and the exchange between open sea and coast.

The residence time and sink of elements is also affected by the **physico/chemical** properties of the various elements. The theoretical retention times can be mentioned as an example; being 0.3 years for lead, about 6 years for cadmium, and 14 years for arsenic in the free water mass of the Baltic Proper.

The large-scale water exchange between basins in the Baltic Sea is given in Figure 2. It should be noticed that the inflow from rivers is the dominating freshwater source compared to, e.g. precipitation over the sea surface which, in turn, is of about the same magnitude as evaporation.

Figure 2. Block diagram illustrating the water exchange in the Baltic. Data in km^3 per year. From Monitor (1988).

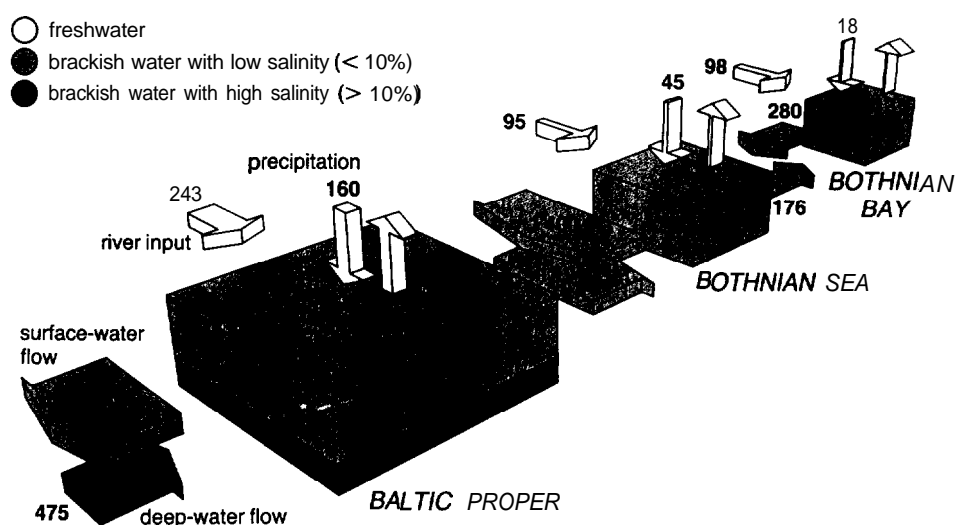

It is difficult to give a stringent definition of a coastal zone. It constitutes a variable and complex system affected by the properties of both land and sea. The morphometry of the coastline is of importance for many key functions of the coast, like the physical, chemical and biological transport mechanisms. This is, amongst others, discussed by **Håkanson et al. (1984)**, **Pilesjö et al. (1990)**, **Wallin & Håkanson (1990)**.

In coastal areas with river estuaries, fjords, semi-enclosed bays, or archipelagos, it is easy to define the border between land and sea compared to the open coasts. In open coasts areas down to 25 metres depth have been accepted, without being too orthodox.

One approach is given by **Håkanson (1990)** dividing the Baltic Sea into three functional zones; the coastal zone, the transition zone and the deep water areas as illustrated in Figure 3. Together with the archipelagos, a large part of the Gulf of Finland, the Moonsund, the Gulf of **Riga**, and the Belt Sea area plus the Kattegat (not indicated on the map) can be regarded as the main coastal zones of the Convention waters which, in general, is in line with the definition accepted in this Report.

Figure 3. Physical geographic zonation of the coastal, transitional or intermediate and deep water areas (Håkanson 1990).

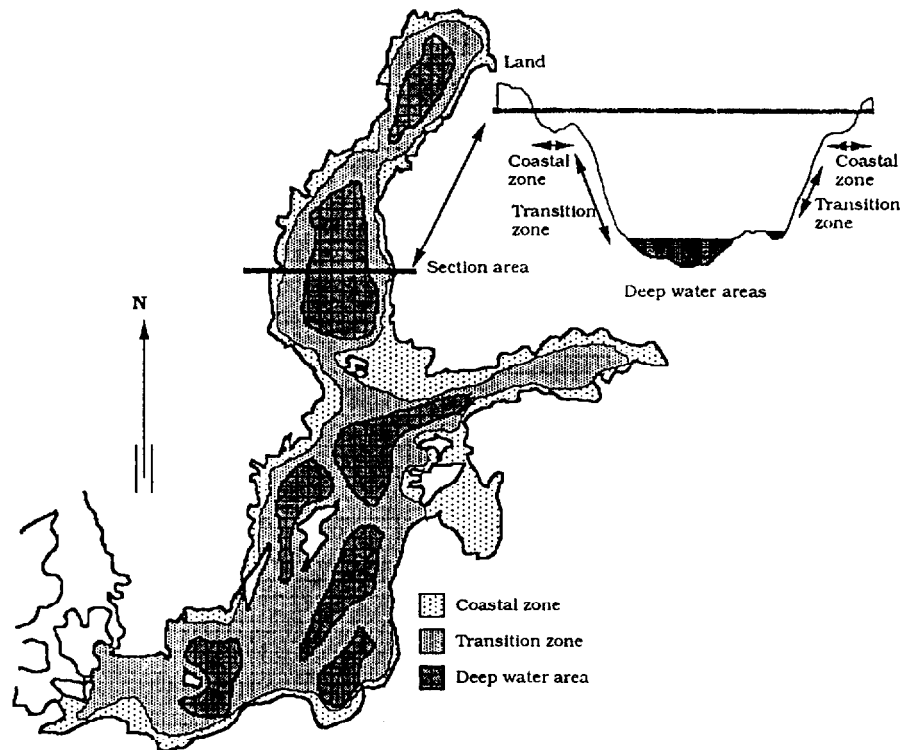

The ecological functions of the main regions of the Baltic Sea area are affected by properties like salinity, temperature and water exchange. There are horizontal gradients from the north/east to the south/west and vertical from surface to the bottom.

Most obvious is salinity, which increases in surface waters from about 0-2 ‰ in the northern Bothnian Bay and in the easternmost Gulf of Finland, to > 15 ‰ in the Kattegat, with a pronounced transition zone in the Belt Sea and the Sound (Figure 4). In all geographical areas local gradients of various extents occur, depending on coastal morphometry and water ventilation capacity.

Of importance for the function of the basins is also the vertical stratification in salinity. The permanent halocline isolates the deep saline water volumes and acts as a “false bottom” where an increased microbiological activity contributes to a recirculation of various elements back to the upper water masses without direct interference of chemical processes in the sediments of deep areas (cf. Grimås 1973). This process is clearly indicated by results presented by Fonselius (1969).

Figure 4. The gradient of salinity in water areas from the Bothnian Bay to the Kattegat .

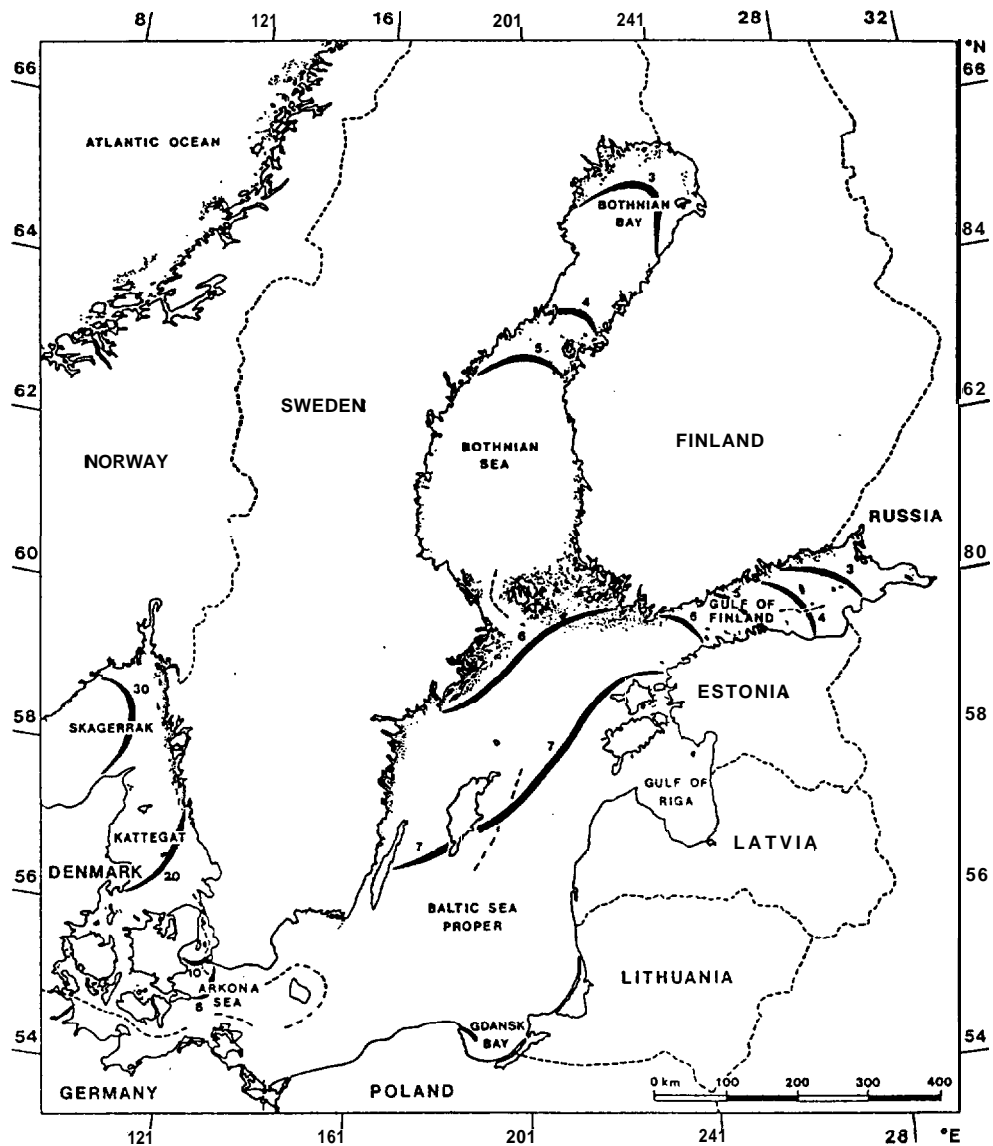

Differences in temperature are also important, as illustrated by the distribution of ice on 1 March 1951 to 1967 in Figure 5 (Thomson & Undin, 1973). The figure indicates the low annual mean temperature to be expected in northern part of the Bothnian Bay and the successive increase through the Baltic Proper to the Kattegat.

There is a wide variation in climate between years. Again, this can be demonstrated by the ice situation in the Baltic Sea, presented by Lundkvist (personal communication) (Figure 6). Without going into details, there is an obvious difference between the maximum distribution of ice during the very mild winter in 1990, in contrast to the very severe winter in 1987. In the first case, ice occurs mainly in the Bothnian Bay and some inner archipelagos. In the second case, ice covers most of the Convention area including the Kattegat. One direct effect of ice is the influence on benthic vegetation which, during cool winters, may be removed down to depths of several meters.

Figure 5.

The distribution of ice on 1 March 1951 to 1967 in the Baltic Sea (from Thompson and Undin, 1973, Håkanson, 1993).

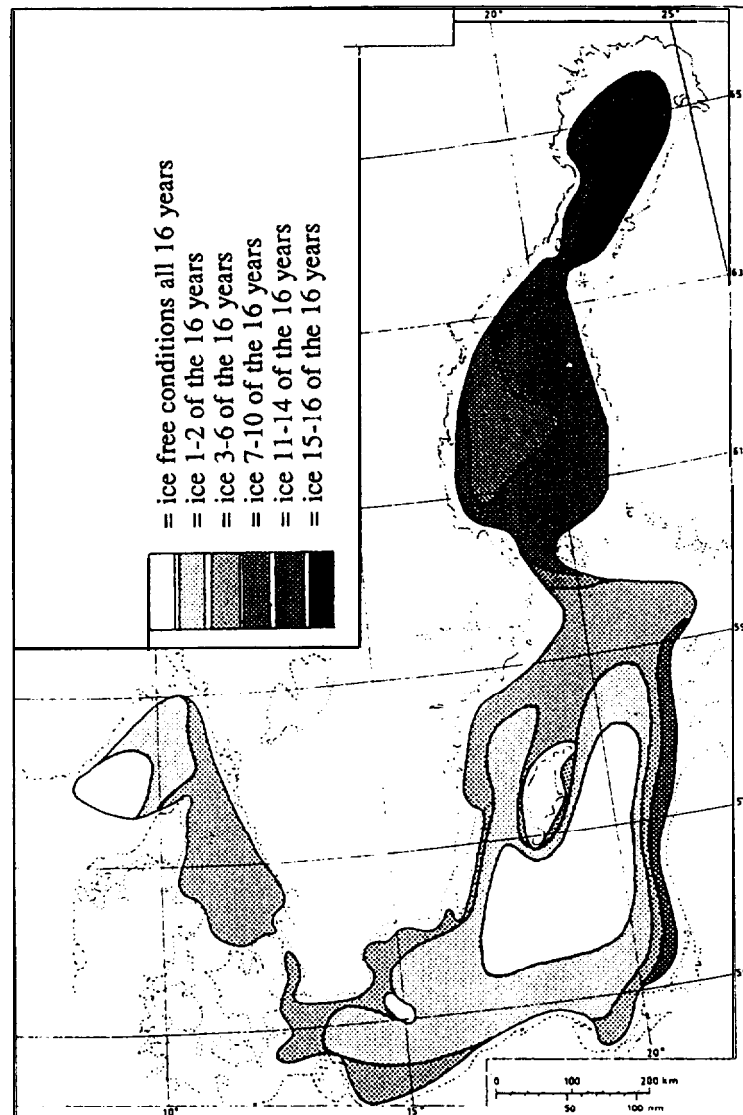

The combination of salinity and temperature render some fundamental properties to the water masses, e.g. isolation by stratifications and ice-cover. The consequences of the various physical and chemical gradients can be described as an ecological gradient via a set of species, biological and physiological processes within the ecosystem, the length of growing period, etc., which can be summarized as a concept of productivity.

Figure 6. Maximum distribution of ice during an extremely cold winter (13 March 1987) and an extremely mild winter (31 January 1990), Lundqvist (pers. comm.).

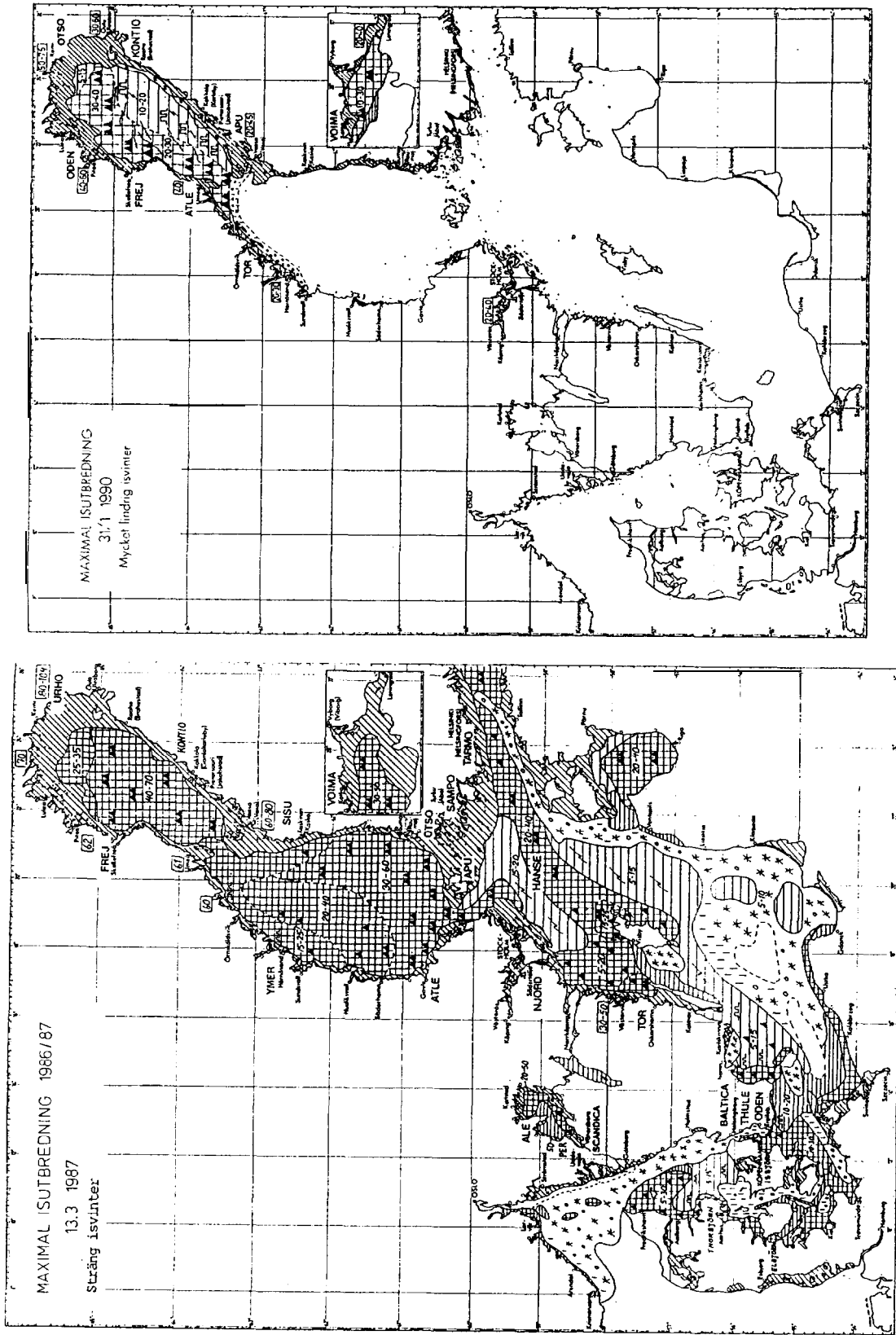

Among large-scale mechanisms, the water transport system in the sea basins is of utmost importance for the fate of pollutants and their effects in the coastal zone. Two illustrations are given for the surface water currents (Figure 7) to cover the whole Convention area.

Figure 7. Surface water currents in the Baltic. A) including salinity (FRP1978), B) USSR (Anon.)

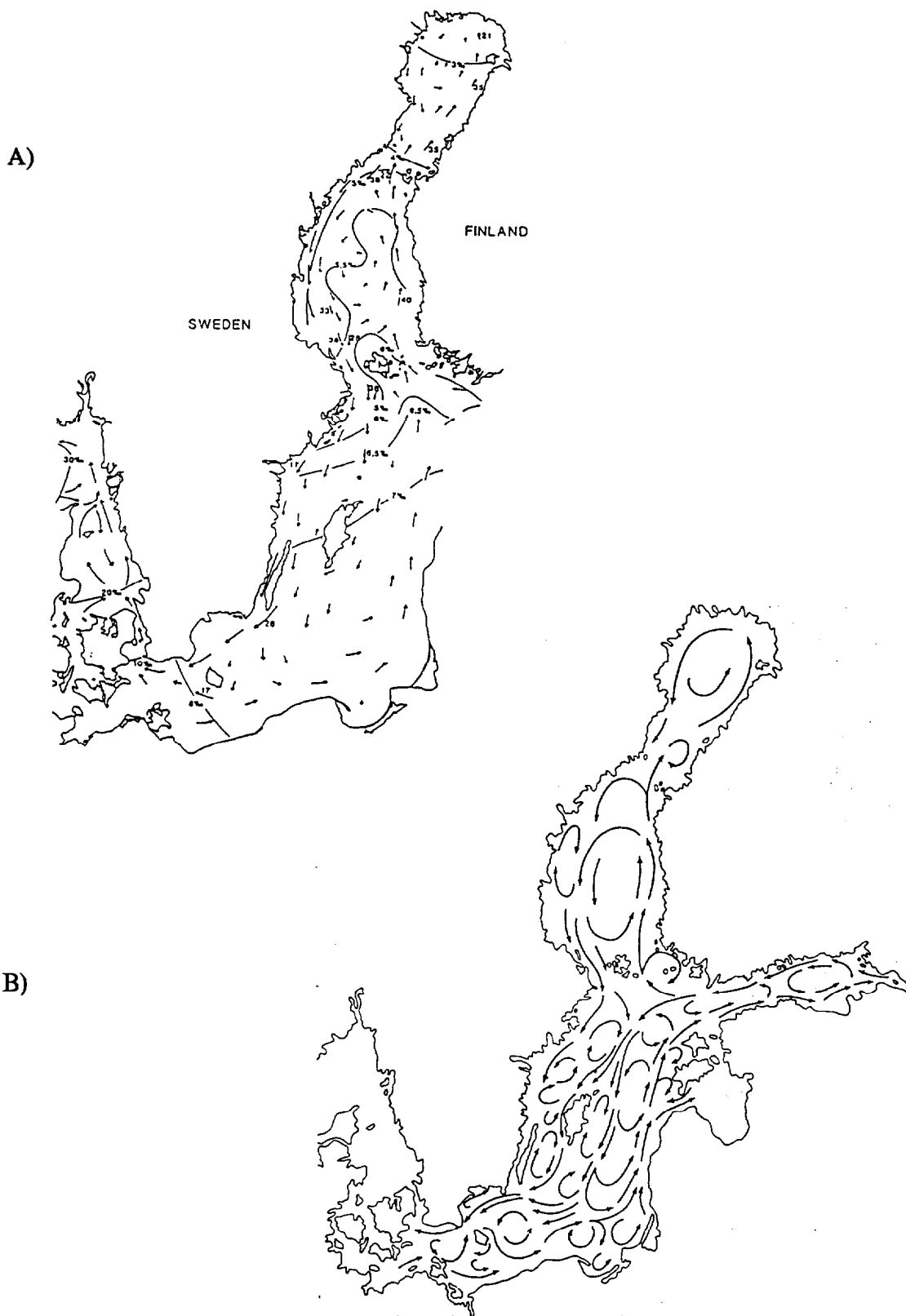

There are some differences in details given in the two alternatives, especially close to the coastal zone. Version A) seems to give a more general description of the net-flow. The main message is, however, the same in both illustrations; an anti-clockwise circulation of water in all basins. This means, for example, an eastward net transport in the south, northwards along the eastern coasts, and a southward transport along the western coast of the Baltic Proper, northwards along the Swedish west coast, and a more complicated net transport in the Belt region.

The coastal current is broken by hydrodynamic processes induced by meteorological phenomena like wind and changes in air-pressure. One example is the upwelling of water along the coasts. This will contribute to a more pronounced geographical dispersion and recirculation of water and pollutants in all the main basins from the main water transport along the coasts into the open areas. Examples of upwelling frequencies along the Swedish coasts are given in Figure 8.

Figure 8. Upwelling frequency in percent of time for some Swedish coastal sections (Gidhagen 1987).

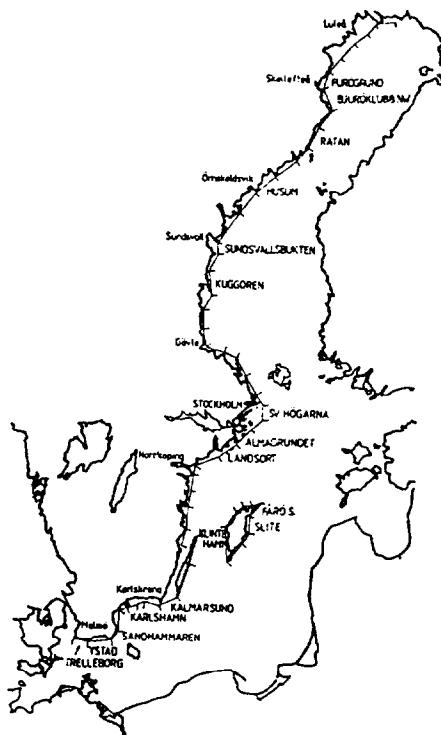

JULY		AUGUST		SEPTEMBER	
	%		%		%
Trelleborg	28	Ratan	25	Kalmar sund	37
Ystad	28	Karls hamn	23	Ratan	30
Ratan	27	Trelleborg	22	Kuggören	27
Bjuröklubb NW	22	Ystad	22	Landsort NE	27
Karls hamn	18	Furögrund	19	Furögrund	25
Kuggören	16	Kuggören	16	Almagrundet	24
Kalmar sund	15	Landsort NE	15	Karls hamn	20
Sundsvallsb.	7	Kalmar sund	13	Bjuröklubb SW	20
Landsort NE	5	Bjuröklubb NW	11	Sundsvallsb.	28
Furögrund	4	Sandhammaren	11	Husum	14
Husum	2	Slite	7	Ystad	11
Almagrundet	2	Almagrundet	6	Trelleborg	10
Klintehamn	2	Sundsvallsb.	6	Klintehamn	10
Färö	0	Klintehamn	5	Slite	8
Sv. Högarne	0	Husum	2	Sv. Högarne	0
		Sv. Högarne	0	Färö S	0
		Färö S	0		

Examples of deviations from the net coastal current direction are also given, e.g. by Poland for the Vistula river water where, in about 50% of observed cases, the water is transported eastwards and, depending on wind directions, 25% was transported northwards and 6% westwards.

The coastal zone can act as a trap or filter for various elements or particles. In the open coastal areas the transfer of elements from land to sea is rather fast. A delay in the rate of transport and the uptake and sink of elements is more effective in the bays and complex archipelagoes, which can be regarded as natural sewage works or cleaning installations for the open sea. In many cases, however, this capacity is over-exploited and many coastal areas are nowadays functioning as sources rather than filters.

REFERENCES

- Fonselius, S. 1969. Hydrography of the Baltic deep basins. - Fish. Bd. of Sweden, Ser. Hydrogr., 23, 97 pp.
- FRP, 1978. The sea; natural conditions and use. - Physical planning, Ministry of Agriculture, 7, 303 pp. (in Swedish).
- Gidhagen, L., 1987. Coastal upwelling in the Baltic Sea - satellite and in situ measurements of sea-surface temperatures indicating coastal upwelling. - Estuarine, Coastal and Shelf Science, 24, 449-462.
- Grimås, U., 1973. Hydrobiologi. - In: Praktisk miljökunskap, Vattenmiljön, Natur och Kultur, 81-94 (in Swedish).
- Håkanson, L., 1990. A new functional view of the Baltic Sea. - Ambio, Special Rep., 7, 19.
- Håkanson, L., 1993. Physical geography of the Baltic. - In: The Baltic Sea Environment, Baltic Univ. Ser., Uppsala, 1-35.
- Håkanson, L., Kulinski, I. & H. Kvarnäs, 1984. Water dynamics and bottom dynamics in Swedish coastal waters. (Vattendynamik och bottenodynamik i kustzonen). - SNV PM 1095, Solna, 228 pp. (in Swedish).
- Monitor, 1988. The marine environment of Sweden - ecosystems under pressure. - SNV, 207 pp. (in Swedish).
- Pilesjö, P., J. Persson & L. Håkanson, 1990. Calculations of coast morphometric parameters and surface water retention time using digitalized chart information. (Digital sjijskortsinformation för beräkning av kustmorfometriska parametrar och ytvattnets utbytestid). - Dept. of Hydrol., Univers. of Uppsala, 76 pp. (in Swedish).
- Thompson, T. & I. Undin, 1973. The ice in the Baltic. - Ymer, Stockholm, 61-82, (in Swedish).
- Voipio, A., (Ed.), 1981. The Baltic Sea. - Elsevier Oceanographic Series, Amsterdam, 418 pp.

3. TROPHIC CONDITIONS AND EFFECTS

3.1. Eutrophication

3.1.1. Background

Eutrophication is a process of enrichment of the ecosystem and is regarded as one of the main problems in the Baltic Sea together with the occurrence of hazardous substances. It is often caused by an increased input of nutrients stimulating the production of organic material, e.g. by algae within the waters. It may also be a result of input of organic matter from outside the water system, e.g. by rivers, sewage treatment plants, pulp mills, etc.

The trophic status can be measured in various ways. One is to quantify the nutrients that are important for plant production. Another is to quantify the result, e.g. the mass of planktonic algae. Both these and other measures are highly variable in the free water mass; seasonally or with a patchiness in vertical and horizontal distribution. The spatial and temporal inhomogeneity in the distribution of physical, chemical and biological parameters is well established by the joint Baltic Patchiness Experiment during 1986 (ICES 1989).

Series of information are available on variables in the free water mass from the participant countries. There are, however, difficulties in comparing the results in time and space because of analytical problems, different techniques used from field to laboratories or incongruity in background information. General problems are discussed by, amongst others, Nehring et al. (1987) and critical evaluations have been made, e.g. by Suursaar (1992a, 1993).

For measures to be taken there is a need to follow the process backwards to the sources. Information on source terms will be available and will form the basis for intercomparison, e.g. between local point sources and effects. There is, for instance, general correspondence between the descriptions of the sites of large point sources, and problem areas of eutrophication, indicated in Figure 66.

Comparisons between various sources are presented in the Second Pollution Load Compilation (HELCOM 1993) which shows that 70-80% of the nutrients and organic matter from land enter the Baltic Sea with rivers and the rest from urban areas and industries. The point sources constitute, however, only part of the total load, especially for nitrogen where about 40% is attributable to direct deposition by precipitation on the sea surface (HELCOM 1991b) and about 10% to nitrogen fixation by algae.

General effects

The eutrophication process affects the physico/chemical conditions of the waters and may subsequently be reflected at the various trophic levels of the system. Such effects are described, for instance, in subchapters dealing with light penetration in water, benthic vegetation zones, toxic blooms, fish and fishery, etc.

The expression "eutrophication" is often given an overall negative implication. It should be kept in mind that during the process in either direction from mesotrophic conditions, there might be possibilities for environmental management to reach an optimal environmental status and a diversity of goals to the advantage of man without losing a vigorous and balanced life in the coastal zone. One example discussed, e.g. among fishery biologists, is an increased

production of harvestable marine products like fish and mussels, which could be regarded as a positive effect.

Unfortunately, most of the examples given point in the direction of exceeding critical limits in the eutrophication process. This is certainly valid for the open basins and for a series of coastal areas. The often observed negative consequence is the overload of organic material and the insufficient amount of oxygen for decomposition of this material. Harmful oxygen deficiency as a consequence of anthropogenic activity should not be accepted; a principle underlined in the Interim Report (HELCOM 1991a). The conclusion will therefore be that a decreased input of nutrients will be the main route of action.

The important role of the trophic status for the general conditions in the waters is underlined by the interaction with other phenomena in the marine environment; not least the occurrence of harmful substances, which is regarded as the other major problem. In spite of the fact that these problems are linked together, they are often handled separately.

The general combination effects are well known. A potential positive effect of increased production of organic material in the marine environment by eutrophication might be blocked by persistent toxic substances at the various trophic levels up to man. One example is the blacklisting of fish with too high mercury concentrations. On the other hand, an overload of organic material might dilute the concentration of hazardous substances at the levels utilized or reflected by top predators, e.g. organochlorines in coastal areas. These opposite effects are focused on in this Report. They were also indicated in Conclusions in the Interim Report (HELCOM, 1991a) on the state of the coastal waters.

3.1.2. Regional pattern

As pointed out above, there are difficulties in a detailed comparison of information from the various countries on free water mass conditions. For that reason the national evaluations of eutrophic problem areas are accepted, as was reflected also in the Interim Report (HELCOM, 1991a). The pattern shown in Figure 66 seems reasonable as a general expression of the eutrophication of the Convention area. There are problems in the outlet region of the Baltic Proper and westwards to the Kattegat. Problem areas are also reported to be rather frequent along the southern and eastern coasts as well as at the large point sources in all countries, e.g. off the large population centres.

The trophic conditions in coastal areas are determined by the input and availability of nutrients from local sources but also, and especially along the open and exposed coasts, by trophic conditions in the open seas.

Looking at the large basins and taking the production of phytoplankton as a measure of eutrophication, the lowest levels are found in the Bothnian Bay (20-30 g C/m³). The primary production in the northern Bothnian Sea is, on a yearly basis, estimated to about 70 g C/m³. Corresponding figures for the Baltic Proper are 100-140, up to 250 in the Belt Sea and decreasing to about 80-180 g C/m³ in the Kattegat. A similar but less obvious gradient applies to the chlorophyll concentration (Figure 9).

Figure 9. Mean chlorophyll-a concentrations (mg/m^3) in summer during two 5-year periods in various areas southwards from Bothnian Bay to Kiel Bay (Schulz et al. 1990).

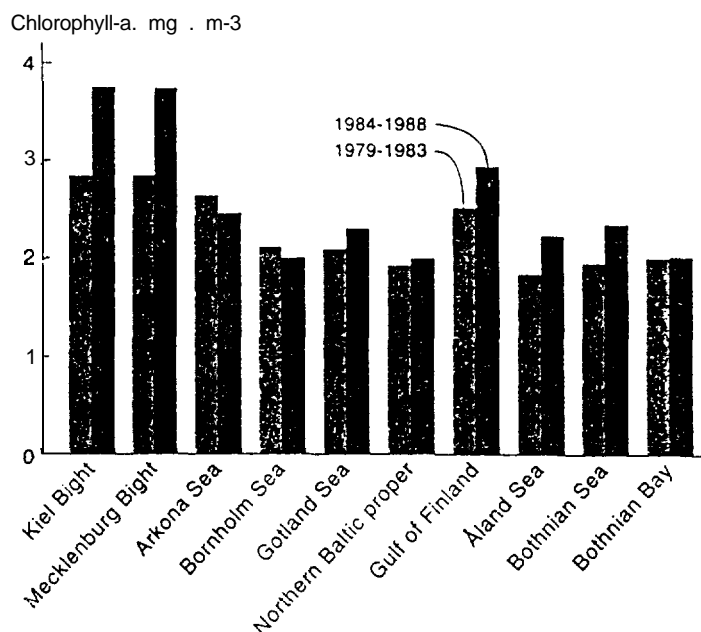
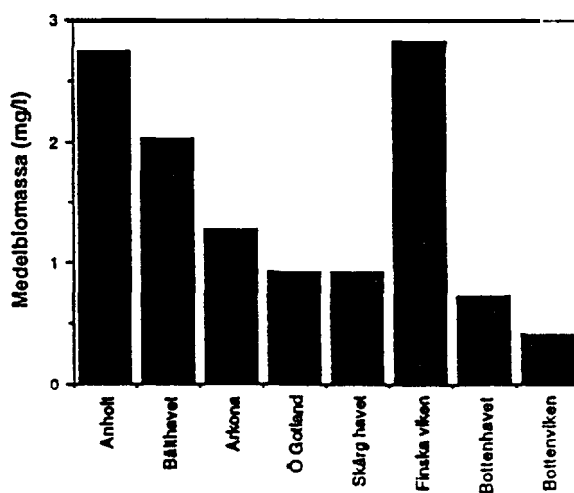

Figure 10. Mean biomass (mg/l) of phytoplankton from the Bothnian Bay to southern Kattegat. The biomass refers to the ice-free periods during 1979-1988 and represents means for spring, summer and autumn situations shown by HELCOM. Data from T. Willén.



Anholt Arkona Archipelago Sea Bothnian Sea
Belt Sea East Gotland Gulf of Finland Bothnian Bay

Another expression is the long-term mean value of phytoplankton biomass during the ice-free season (1984-1988), which has varied between 0.4 mg/l in the Bothnian Bay to 2.7 mg/l wet weight (ww) in the Kattegat (based on figures given by Willén et al. 1990). High levels are reported from the Gulf of Finland, as shown in Figure 10 (Persson, 1993).

The coastal areas often have a higher trophic status compared to the open water areas as an effect of the input of nutrients by rivers and emissions from coastal point sources. These conditions are strengthened by the transport of elements by water currents and the tendency to press discharges against the coasts in an anticlockwise direction.

There is also, for natural reasons, a gradient from local sources, testified by various countries as well as the annual rhythm of primary production. Some principles are demonstrated in Figure 11, comprising results of a 5 years study in the Bråviken Bay at the Swedish Baltic coast (Andersson & Grimås, 1977). The Bay (35 km long) is divided into three zones where the phytoplankton biomass is plotted over time, adjusted to the spring bloom in Marviken situated in the mouth of the Bay. For each step taken inwards, the peak in spring is decreasing. This is an effect of inflow of suspended material, discharged by the River Motala in spring at the town of Norrköping in the innermost part of the Bay.

Figure 11. Phytoplankton biomass, $\mu\text{g/l}$, (mean of five summers) in a gradient of the Bay of Braviken (after Andersson & Grimås 1977).

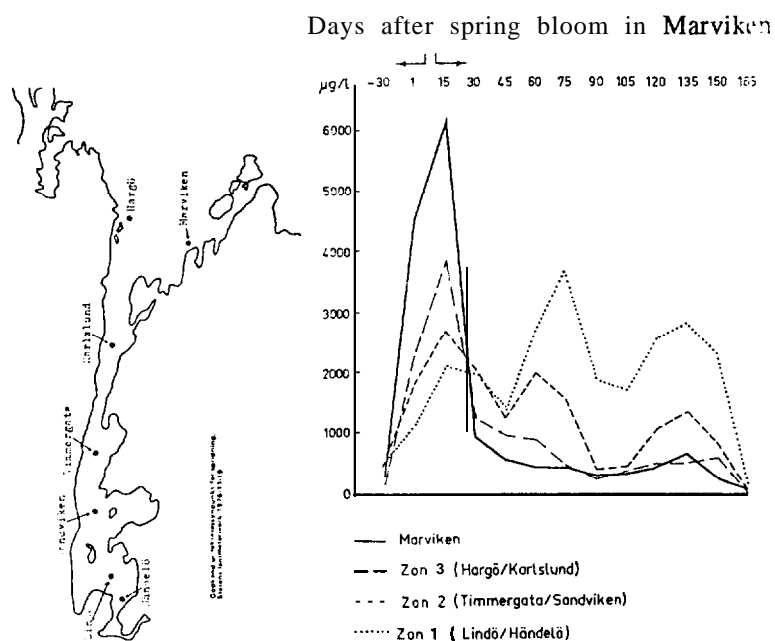

During the rest of the summer the biomass is low in the outer waters at Marviken but increases successively inwards, being rather compact during whole summer in the innermost zone 1. This seems to reflect the nutrients available for primary production in the gradient. It also indicate late summer to be the best season in this part of the Baltic Sea to distinguish between areas affected by eutrophication (cf. Figure 18). Such an approach is given by Grimås & Ehlin (1975) at 14 stations in August during the 1960s along the coast from north of Stockholm to the Braviken Bay with biomass values < 0.2 mg/l wet weight in background areas and up to 2.5 mg/l in various eutrophicated areas.

Comments from various countries

In the **Bothnian Bay** and the main part of the **Bothnian Sea** eutrophication is reported mainly in local areas close to riverine inputs, municipal waste water outlets or discharges from pulp and paper industries. Due to favourable mixing conditions with relatively good status in the open seas the effects of eutrophication are small compared to many southern coastal regions, or are limited to problems, which are being brought under control as a result of measures taken. Oxygen deficit might still occur in some isolated inner parts of bays and archipelagos. These, however, have been reported to be improving in quality during the last decade.

An overview of the chlorophyll-a concentrations along the Finnish coasts in 1990 (Eloheimo & Pitkänen 1992) and in 1991 (Eloheimo 1993) is given in Figure 12, and underlines the relatively low levels found in the Gulf of Bothnia, especially compared to the conditions in the Gulf of Finland.

No distinct trends are reflected in the zoobenthos composition or biomass in the Gulf of Bothnia. Long-term cyclic fluctuations in the open sea are described for species of crustaceans like *Pontoporeia* by Andersin et al. (1978). The conditions in the locally polluted areas have improved during recent decades.

*

The Finnish Archipelago Sea, in the transition zone between the southern Bothnian Sea and the Baltic Proper, is the largest archipelago area within the Convention area. The inner part is clearly eutrophic as a consequence of loading and a complex morphology which limits water exchange. Despite strong removal of phosphorus, minor improvements have been observed off Turku, being the point source with the largest size. In middle and outer parts of the archipelago there are signs of increasing eutrophication, possibly as a consequence of intense fish farming. Such effects are studied, i.a. by Rönnerberg et al. (1992), on growth, epiphytes and nutrient content of *Fucus* in the Åland archipelago. Some variable effects observed, e.g. in the development of macroalgae, are also considered to reflect an influence of the deterioration of open sea waters (cf. sub-chapter 3.2).

*

The **Gulf of Finland** has the highest degree of eutrophication in the Finnish coastal water areas, and the Gulf is one of the most affected peripheral areas of the Convention (cf. Figure 10), which is noted also by the other countries bordering the Gulf. The phytoplankton biomass is clearly elevated in the middle and outer archipelago as well as in the open Gulf compared to the corresponding zones of the western parts. Vernal blooms are massive and blue-green algal blooms are often reported (Pitkänen et al., 1991).

Figure 12. Chlorophyll-a concentrations measured along the Finnish coasts in 1990 (a) and 1991 (b) (Eloheimo & Pitkänen 1992).

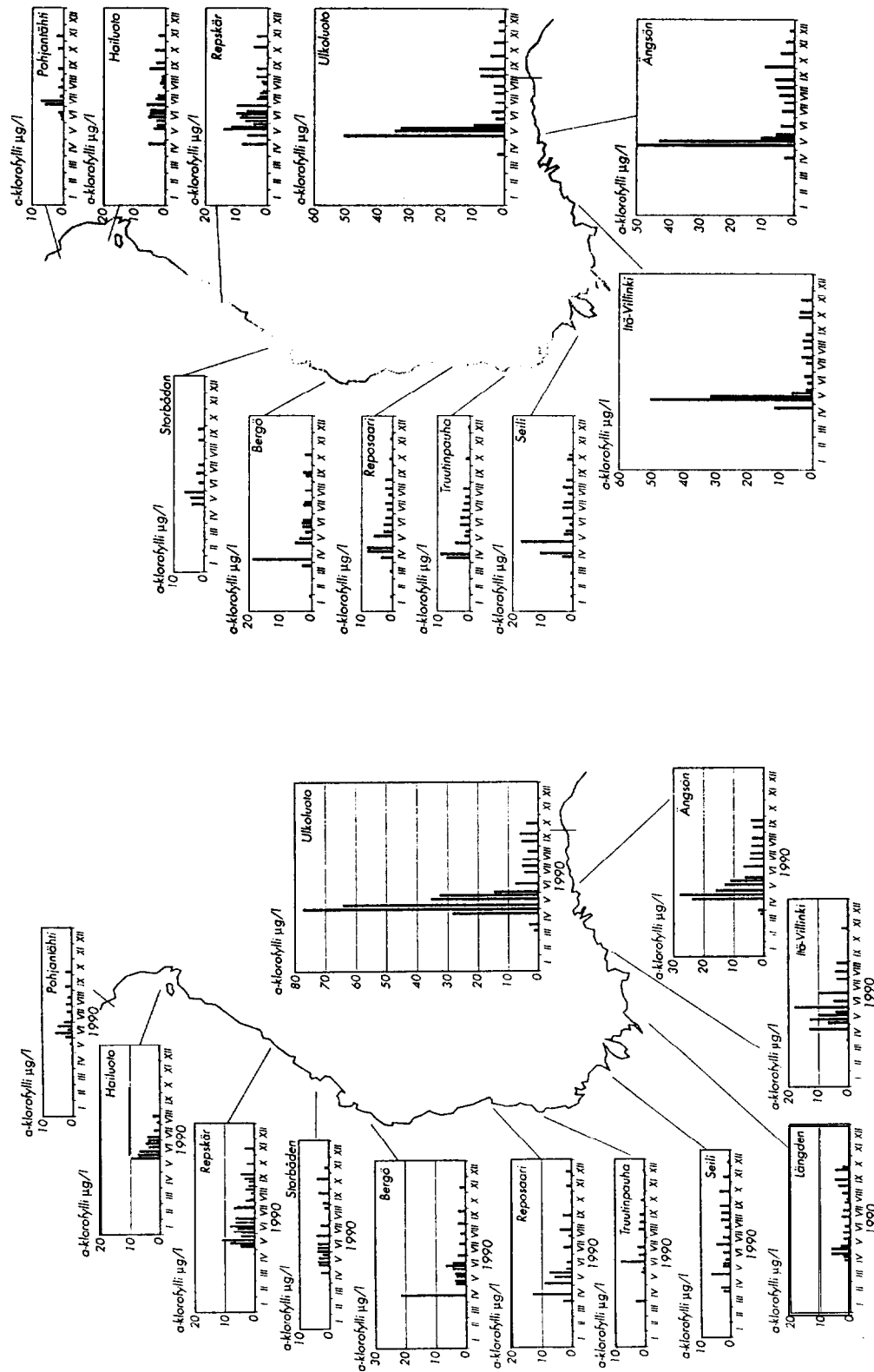

There is no sill separating the area from the open Baltic and marked oxygen depletion has earlier been observed only in the deepest parts of the Gulf. During the last decade the oxygen situation has improved, partly as an effect of decreased salinity and a weakening of the stratification facilitating the exchange of water (Suursaar 1992a). This includes **also** the near-bottom waters of the easternmost parts, thanks to the effective vertical mixing of water (Pitkänen 1991).

The studies include, among others, a joint Finnish/Soviet expedition in late autumn 1990 (Pitkänen et al., 1993) from the open Gulf to the inner Neva estuary. Clear direct effects of the River Neva and the St. Petersburg region were observable at a distance of 100 km from the mouth of the river and covering an area of 3000 km², i.e. 10% of the total surface of the Gulf of Finland. The high nutrient loading discharged by the Neva River and St. Petersburg is utilized by phytoplankton rapidly. This has been seen (Figure 13) as sudden decrease of soluble nutrients directly off the dam (Pitkänen et al., 1993). As a secondary effect, remineralized nutrients affect the productivity, especially along the northern coast, due to the horizontal water flow pattern in the sea area. The gradient in the concentrations of nutrients in the whole area of the Gulf of Finland is illustrated in Figure 14.

The eutrophication indicated by all measured parameters is strongest in the inner Neva estuary (outside the dam) where the river water and the bottom water from the Gulf mix and, for phytoplankton, also outside Kotka. The values for chlorophyll-a and phytoplankton are given in Figure 14, which also shows that oxygen saturation below 50% near the bottom is seldom observed.

The important role of the Neva estuary as a regulator of nutrient fluxes as well as a trap for particulate organic matter is underlined by, i.a., Pitkänen (1991), who concludes, however, that the understanding of nutrient dynamics in the area is far from complete.

Among the local areas can be mentioned the outer Kotka region, which belongs to one of the most eutrophic Finnish parts of the archipelago of the Gulf of Finland. Another is the Helsinki area, where a phosphorus load reduction of about 75% during the 1970s has improved the status mainly of the inner waters, which is reflected in a strong decrease of phytoplankton biomass and chlorophyll-a concentration. In the outer archipelago, however, the trophic degree has increased, exemplified by a three-fold increase in primary production during the period 1970-1986 (Järvekülg et al., 1988). This seems partly to be an effect of the increased nutrient pool in the open Gulf.

*

In the national reports, two areas along the northern Estonian coast are pointed out as especially eutrophicated; the Narva Bay and the Tallinn Bay, where the concentrations of nutrients in winter are 2-4 times higher than in the central part of the Gulf of Finland. Oxygen content is high almost everywhere in the open sea. Looking at data presented for 1980-1990 from Tallinn Bay (Suursaar 1992b), lower oxygen contents occur in the inner Tallinn Bay and especially drastically below the ice cover in winter. Eutrophication is also a fact in the regions of Haapsalu at the west coast and Pärnu in the northern part of the Gulf of Riga.

Long-term changes in the bottom fauna of Tallinn Bay have been reported by Järvekülg & Seire (1985). During the period 1963-1979 the inner part of the Bay was characterized as polysaprobic. The great changes in the bottom fauna and the boundaries of the zones of

saprobity are mainly due to the duration and extent of fast-ice, changes in the amounts of influx of allochthonous organic matter in different parts of the bay and non-periodical changes in the dissolved oxygen in the deep waters of the Gulf of Finland.

Figure 13. Chlorophyll-a, phytoplankton and oxygen conditions in the north-eastern part of the Gulf of Finland (after Pitkänen et al. 1993).

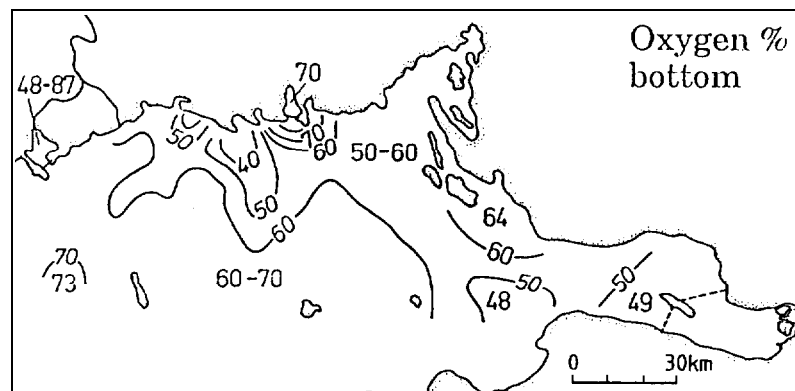
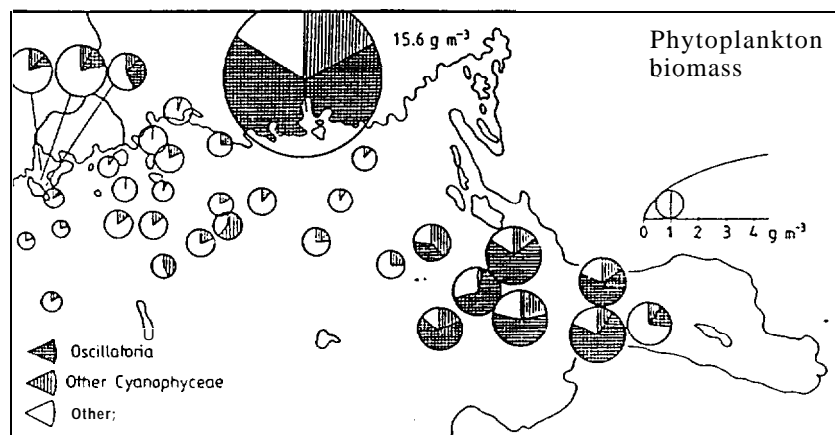
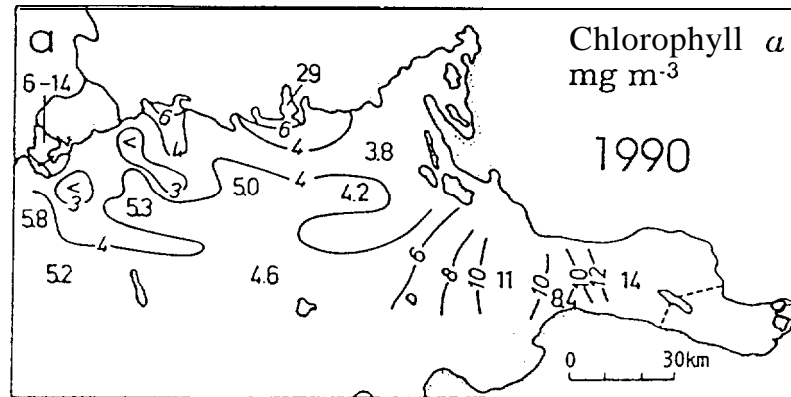

Figure 14.

The gradients of ammonia, nitrate and phosphate concentrations in the Gulf of Finland from the inner Neva estuary to the Baltic Proper. Results from joint expedition, 5-23 November, 1990. (source: Finnish Institute of Marine Research)

RV ARANDA
RV ARNOLD VEIMER
RV RUDOLF SAMOILOVICH

SURFACE NH₄
0-8.0 MMOL/M³
NOVEMBER 1990



RV ARANDA
RV ARNOLD VEIMER
RV RUDOLF SAMOILOVICH

SURFACE NO₃
3.1-19.2 MMOL/M³
NOVEMBER 1990

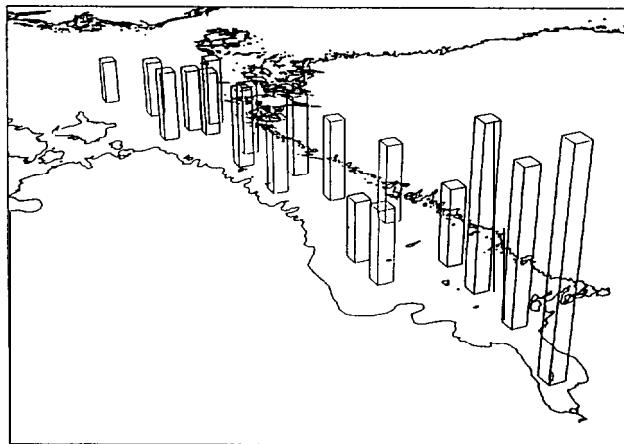

RV ARANDA
RV ARNOLD VEIMER
RV RUDOLF SAMOILOVICH

SURFACE PO₄
0.3-1.1 MMOL/M³
NOVEMBER 1990

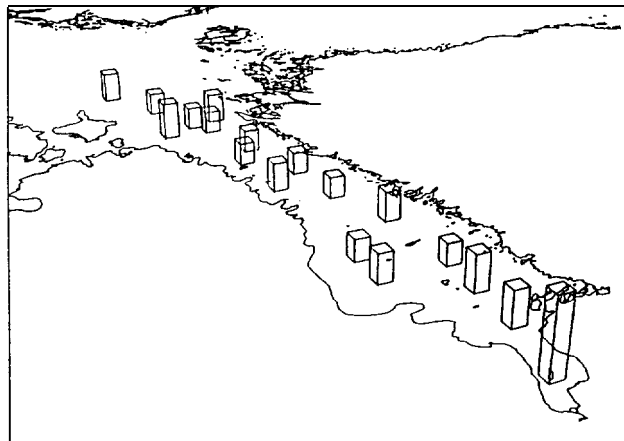

Changes of the **Pärnu** Bay ecosystem during recent decades are noted by Ojaveer et al. (1988). The concentrations of nutrients and the primary production had doubled since the **1970s**, bottom vegetation had degenerated and the structure of animal communities had changed to those favoured by eutrophication.

*

Some parameters concerning eutrophication of the **Gulf of Riga** are described in the two HELCOM Assessments of the status of the open Baltic. Studies on long term trends show an increase of the winter concentrations of nutrients in the surface layer and a significant negative trend of oxygen concentrations in the near-bottom water layer in the central part of the Gulf during 1963-1986. In summer (August) the oxygen concentration was, however, very seldom below 5 ml/l above 15 meters and 4 ml/l down to 50 meters depth.

The negative trend for oxygen described by Berzins (1990) for the 24-year period (1963-1986) in the near-bottom water layers could not be confirmed by Astok et al. (1991a) for the period of 1979-1988 but they confirm the trend of further increased nutrient concentrations. They also report that the chlorophyll-a content in the spring period varies within large ranges (2-20 mg/m³), the maximum concentrations measured in estuarine waters of Daugava, Lielupe and Gauja rivers. In autumns the maximum values (5-15 mg/m³) were obtained in mouths of rivers, which indicate eutrophication. Astok & Suursaar (1991) emphasize that the state of pollution in the coastal areas of the Gulf foremost depends on the major point sources and local polluters like the towns of **Pärnu** and **Riga**.

Data describing long-term development of organisms in the pelagial of the Gulf of **Riga** have been delivered at the 13th symposium of BMB (Kostrichkina et al. 1993). There is a successive increase of phyto- and zooplankton over time both in numbers and biomass, reflecting the enrichment of waters of the Gulf.

The studies of zoobenthos in the Gulf during the period 1945-1985 show a large increase in biomass combined with a small decrease in abundance (Lagzdins, 1990). The development in biomass is explained by an increase of molluscs and a decrease of crustaceans, e.g. *Pontoporeia*, in polluted coastal areas.

*

The situations in the Curonian and Vistula lagoons are described, i.a. by Astok et al. (1991b). Both bays are almost closed estuarine areas separated from the Baltic by the Kura spits and Vistula sand bar. The dominating depths are less than 10 meters which facilitates an effective mixing of the water masses. This also results in a constant resuspension of bottom sediments, giving a very low transparency of the waters; often less than one meter.

In the Curonian Lagoon the most polluted areas are the south-eastern part, off the mouth of Nemunas River and the area close to the Klaipeda Port. It has not been possible to find any reliable trend in the nutrient concentrations during the last decade. In spite of the obvious signs of eutrophication, high nutrient concentrations, phytoplankton blooms from spring to autumn (occasionally up to 50 mg/l wet weight during blooms of blue-green algae) and reported high values of BOD, the oxygen conditions are mainly good as an effect of water turbulence through wind and waves. A minimum saturation of 50-60% is reported from the southern part in August.

Oxygen deficit has, however, been observed in bottoms waters and sediments at stations studied in the Klaipeda area, influenced by wastes from a pulp and paper mill and sewage water from the town (Kucinskiene, 1989). In rather shallow bottom areas (8m) the sulphate reduction process in the surface sediment (0-2cm) was up to 3.95 mg S_2/dm^3 per day in 1987. A tendency for an increase of the sulphate-reducing bacteria concentration since 1985 was also noted in the sediments in the northern part of the Lagoon.

In the Vistula Lagoon near the mouth of the Pregolia River the oxygen content is low during summer. Oxygen depletion has been notified in 1979, 1982 and 1983 and in 1988 absence was observed from May to November. The concentration of H_2S has been as high as 1.0 mg/l in the near-bottom waters. In other parts the conditions have been normal due, e.g., to the mixing of water from the sea; the inflow being about 17 km³ annually. The biomass of phytoplankton in the eastern part of the Vistula Lagoon is reported to be 1.8 mg/l ww on an average, which is at about the same level as in the Belt Sea (cf. Fig. 10).

*

Figure 15. The development of phyto- and zooplankton in the Gulf of Riga exemplified by data from August. Solid line=number $\times 10^6$ cells/m³, dotted line=biomass, mg/m³ (Kostrichkina et al., 1993).

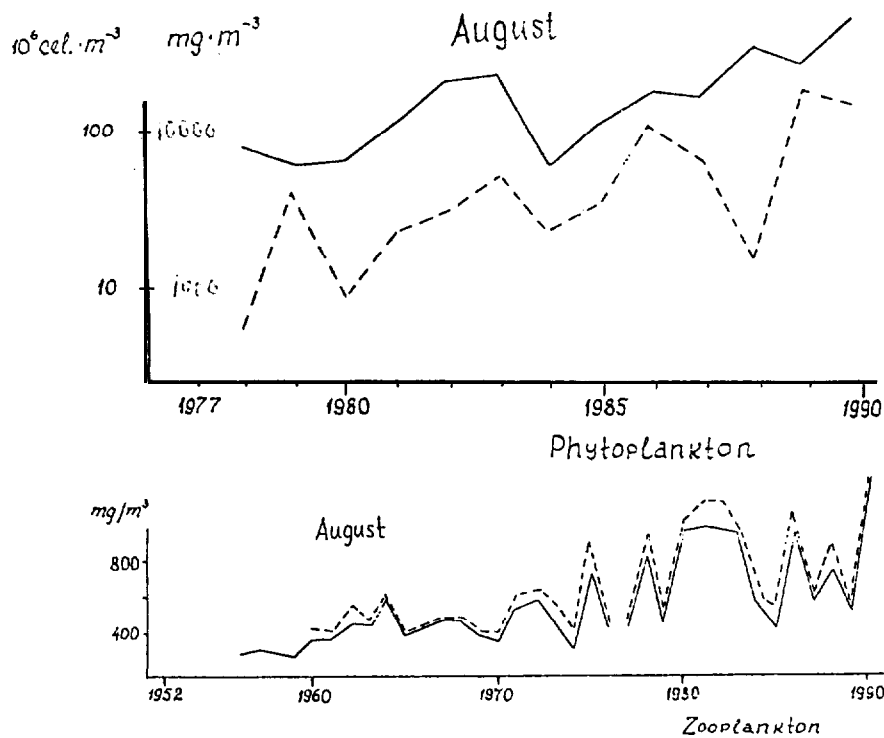

The shorelines of Poland are exposed to the open Baltic except for two major bays: the Gulf of Gdansk and the Pomeranian Bay. The exposed conditions result in a well-mixed and aerated water column of the shallow coastal area. The eutrophication status along the central coasts, thus, in general reflects the conditions of the southern Baltic Sea.

The common consequence of eutrophication, oxygen deficiency, occurs only in small and semi-isolated areas like the Inner Puck Bay in winters with extended ice cover (Trzosinska & Cyberska 1992). Oxygen depletion approximately to 50% of saturation is periodically recorded in all coastal regions in the vicinity of river mouths, mainly in summer and autumn.

The general development in the deep area of the Gulf of Gdansk is described in the Second Assessment of the Baltic Sea (**HELCOM 1990**), e.g. nutrients by Trzosinska and oxygen conditions by Cyberska. Analyses of long-term fluctuations in nutrient concentrations in the winter surface layer show an increase in phosphates until the late 1970s and increase in nitrates continuing also during the 1980s and an overall decrease in silicates. There was also a negative trend in the oxygen concentrations in the near-bottom waters (100-108 m depth) over the past 30 years. Concentration level and frequency of hydrogen sulphide appearance, recorded mainly in late summer and autumn, increased significantly in 1986-1989.

In the assessment of the effects of pollution in the coastal area of Poland, 1984-1989, Trzosinska (1992a) considers the Gdansk Deep to be the best testing ground for studies of long-term variations of the **trophic** conditions. At shallow stations no statistically significant trends were found in spite of an obvious accumulation of nutrients. Figure 16 shows mean concentrations of phosphate, nitrate and silicate in the coastal area, which are generally higher than off-shore. This over-abundance of nutrients along the coast is, however, very variable depending on season, river outflow, etc. The highest ratios between nutrient concentrations in the coastal zone and the open sea occur, as a rule, in the estuaries, foremost in the Pomeranian Bay. On the other hand, these ratios increase considerably in spring and/or summer (fertilizers wash out), viz. up to 11 for nitrate, up to 3 for phosphate and up to 2 for silicate, on average. In the case of organic fractions of total nitrogen and phosphorus the corresponding relations appeared to be more stable over the year and more complicated regionally. They are also less reliable because of analytical problems.

Primary production and the distribution of chlorophyll-a is described by Renk (1992). The mean production of the whole Gulf of Gdansk is 32% higher than that at the Gdansk Deep where the mean annual production over a series of years amounts to 125 g C/m³; which is well in agreement with the figures 100-140 g C/m³ given by Persson (1993) for the Baltic Proper. Mean annual concentrations of chlorophyll-a are given in Figure 17, demonstrating a general tendency to decrease towards the open sea and certain similarities between the bays. Besides a regional variation, some positive long-term trends were identified for both the primary production and the chlorophyll-a concentration.

*

Two-thirds of the **German Baltic coast** is part of the transitional Belt Sea area through which most of the Baltic Sea water is exchanged. In combination with freshwater inflows, this causes the salinity to be highly variable. The lowest value, less than 1 PSU, is reported from the Oderhaff (western part of the Oder Estuary/Szczecin Lagoon) and the highest, above 25 PSU, in the bottom water outside Flensburg Fjord near the Danish Straits. The salinity reflects the variability of a series of other properties from fresh to marine waters and the complexity of the mixing zones.

Figure 16.

Mean concentrations of phosphate (unbroken line), nitrate (dashed line) and silicate (dotted line) in the surface water layer (0-10m) of the Polish coastal zone in winter (a), spring (b) and summer (c) (Trzosinska 1992a).

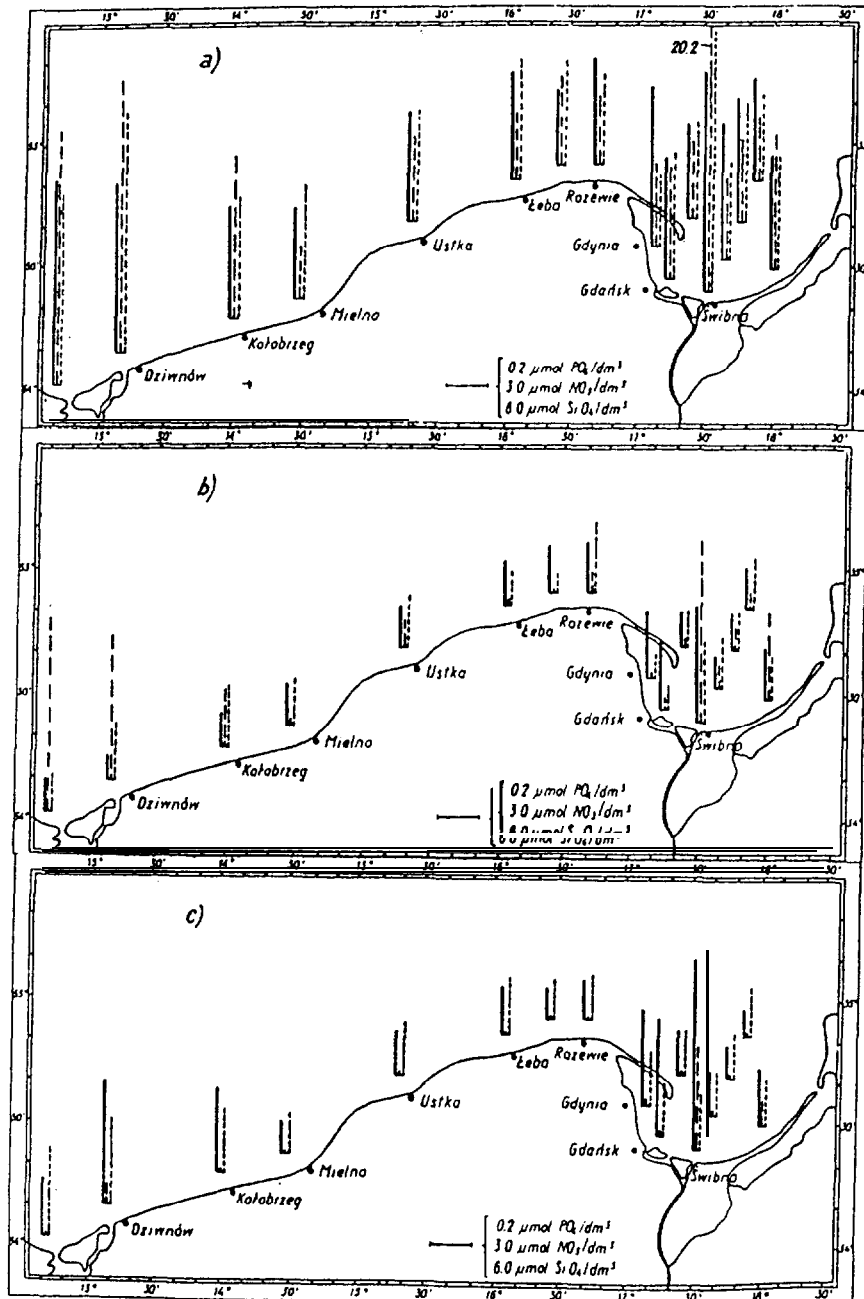

Eutrophication is regarded as the major environmental problem in the German coastal waters, especially in the semi-enclosed fjords and boddens. A comprehensive assessment concerning eutrophication of the German Bight and Kiel Bay has been published by Gerlach (1990). During the past three decades both nitrate and phosphate concentrations have increased. The elevated nutrient concentrations have resulted in an increase in primary production (at spring bloom by 25% in 1984 compared to 1972), a prolongation of algal blooms and changes in phytoplankton species composition.

The conditions in the coastal zone are reflected in Figure 18 which demonstrates the mean annual chlorophyll-a concentrations in waters from Mecklenburg-Vorpommern during 1984-1988. In the outer waters a maximum of 7mg/m^3 is noted in Lübeck Bay in the west (cf. Figure 9) and 26mg/m^3 in the Gderhaff in the east during spring. The corresponding maximum figures for the inner waters occur in summer and are 50mg/m^3 in the western and 140mg/m^3 in the eastern area.

Figure 17. Distribution of chlorophyll-a in the surface layer (0-10m) of the southern Baltic in 1987-1990 (Renk 1992).

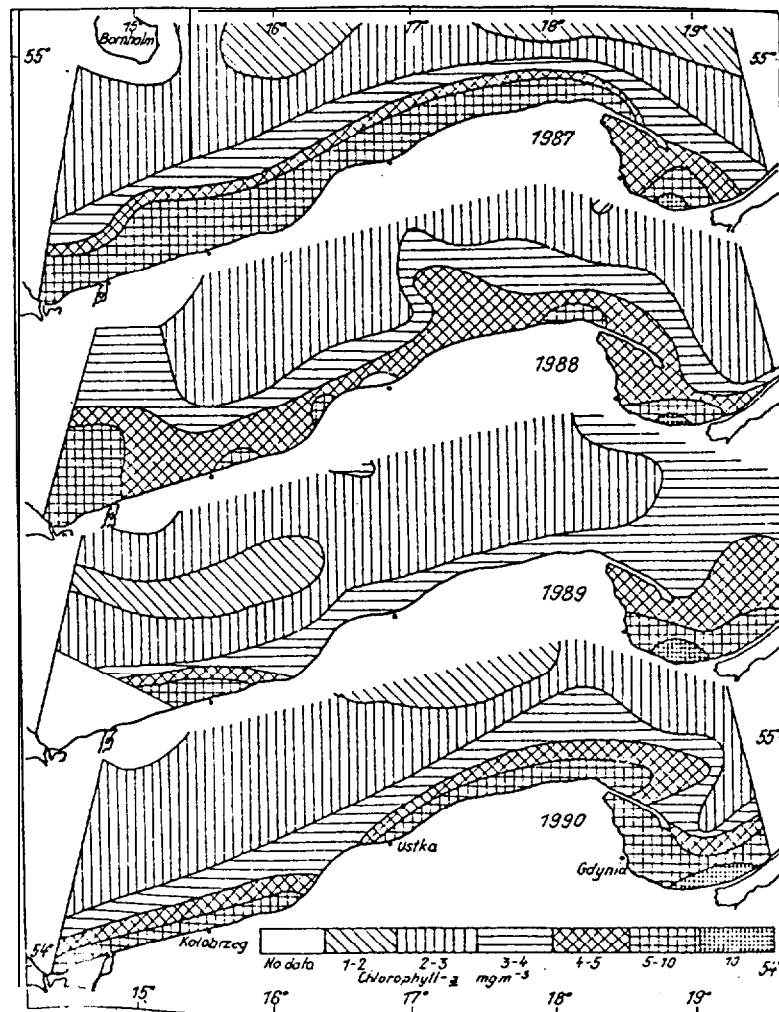
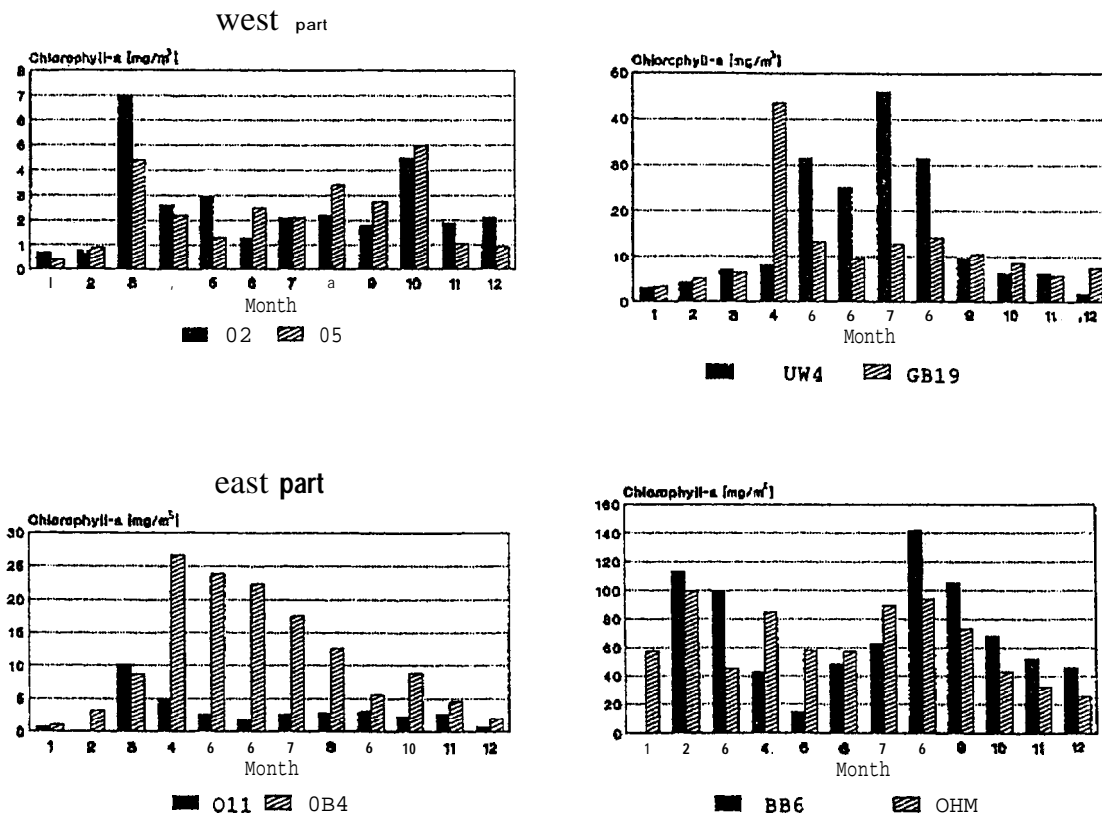

Figure 18. Mean annual chlorophyll-a concentration in waters of Mecklenburg-Vorpommern, 1984-1988. In mg/m^3 .



A

B

A) Western and eastern part of outer coastal waters
 02 = Lübeck Bay, 05 = Warnemünde, 011 = east Rügen, 0B4 = Oder Bay

B) Inner coastal waters
 UW4 = Unterwarnow, GB19 = Greiswald Bodden, BB6 = Barther Bodden, OHM = Oderhaff

An obvious consequence of the increased primary production is the oxygen deficiency. It has been observed occasionally in the western Belt Sea including Kiel Bay during the last 100 years. In the early 1980s the situation changed and oxygen deficiency has since then occurred almost yearly. There is a negative long-term trend and an annual decrease of 0.12 ml/l from 1979 to 1990 in the bottom water of the Kiel Bay during the oxygen autumn minimum (Ertebjerg et al., 1990).

In September 1981 a catastrophe on a scale never before observed occurred. High concentrations of hydrogen sulphide ($> 10 \mu\text{mol/l}$) in the bottom water below 20m depth were observed in the Kiel Bay, Fehmambelt and Mecklenburg Bay (Ehrhart & Wenck, 1984). An area of about 750 km², which is 29%, was affected (Weigelt & Rumohr 1986, Weigelt 1987). Since then hydrogen sulphide has occurred occasionally during the 1980s, affecting smaller areas in Kiel Bay and Lübeck Bay. In the enclosed and eutrophied inner part of Flensburg Fjord, hydrogen sulphide has been recurrent in most years since 1979.

Benthic animal communities are described, i.a. in the HELCOM second periodic assessment (Gosselck & Rumohr 1990). The fauna living at depths greater than 20m in Kiel Bay, Mecklenburg and Lübeck Bights are severely damaged or destroyed periodically in late summer and autumn because of the oxygen deficiency. Due to re-oxygenation of the bottom water in winter and spring, the benthic community changes to an opportunistic polychaete community and ends with dead zones or residual assemblages made up of only 1 to 4 well-adapted species.

In shallower regions the benthic fauna is diverse and achieves high biomasses. Brey (1986) found a four-fold increase of biomass in sandy sediments of Kiel Bay between 1960s and 1980s. A similar trend is reported from the other areas. The benthic community collapsed in autumn 1988 in the Mecklenburg area when oxygen-depleted water advanced almost to the coast. Such events have been reported by Bachor (1988) but not with such damage to the zoobenthos. Whether this reflects a gradual deterioration of the situation in the previously intact parts of Mecklenburg Bight or a freak event caused by unfavourable hydrographic conditions is uncertain (Gosselck and Rumohr 1990).

*

The **Danish water areas** are shallow, with depths less than 30 meters. Only in the eastern part of Kattegat do deeper areas occur along the Swedish coast. The conditions of the individual waters are dependent on currents and water exchange with adjacent areas and not least the open sea areas. The current pattern changes depending on wind conditions over the entire North and Baltic Sea areas. Especially in the **Kattegat/Belt Sea**, the surface currents alternate between out- and ingoing directions. Conditions vary from open coastal areas with good water exchange to more or less closed inlet areas where local conditions are of vital importance for the water quality.

Winter concentrations of nutrients are patchy. Since 1975 there has been a general increase in nitrate concentrations; the largest in the Belt Sea and southern Kattegat and lowest in the Arkona area and southern parts of the Sound. Phosphorus has also increased but less drastically than nitrogen. The largest increase of phosphorus occurred in the Kattegat and the Belt Sea and in the Sound there is a decline, possibly as a result of reduced input.

The daily production during the summer period has increased significantly in the western and southern Kattegat, the Sound and the Great Belt since the middle of the 1970s (Schultz et al., 1990). In the eastern Kattegat no significant increase has been determined since 1954. In areas with longer time series no significant changes can be seen from the 1950s to the early 1970s. From the 1970s to the 1980s the summer production has about doubled.

Oxygen concentrations in deeper waters have generally decreased during the last decade and periods with low oxygen concentrations have tended to last longer and occur more frequently. The consequence is obvious for the benthic animal community where biomass has decreased

in the southern part of Kattegat and fish mortality is reported almost every year since 1981 from various parts of the Danish coasts.

Due to low precipitation and riverine run-off, the nitrogen loading has been relatively low since 1989. As a consequence, phytoplankton biomass and production have decreased in some Danish fjords and bights (e.g. the Limfjorden, the largest Danish inlet to the Kattegat), Secchi-depth increased, and oxygen conditions improved in recent years. For macrozoobenthos the species diversity, **areal** distribution and biomass are increasing (Ertebjerg et al., 1992). The recent positive development, which is also seen in benthic vegetation (cf. Subchapter. 3.2.), is mainly due to a meteorologically determined decrease in the nitrogen loading. Besides these effects induced by climate, a real reduction in nitrogen loading is expected in the near future, which will improve the ecological conditions in the Danish coastal zone.

*

The Swedish coasts border all the main basins of the Convention area. The levels of eutrophication in the open waters are, thus, of interest in the respective coastal zones along a gradient from the Bothnian Sea to the Kattegat. As mentioned above, such direct effects might be seen mainly in the open coastal waters. Archipelagoes are, however, covering about 50% of the total length of the Swedish coasts which affects the quality and increases the spectrum of variability and patchiness of the conditions readable.

Figure 19. The concentration of chlorophyll-a is $> 4\text{mg/m}^3$ during late summer in Swedish coastal waters (Persson, 1993).

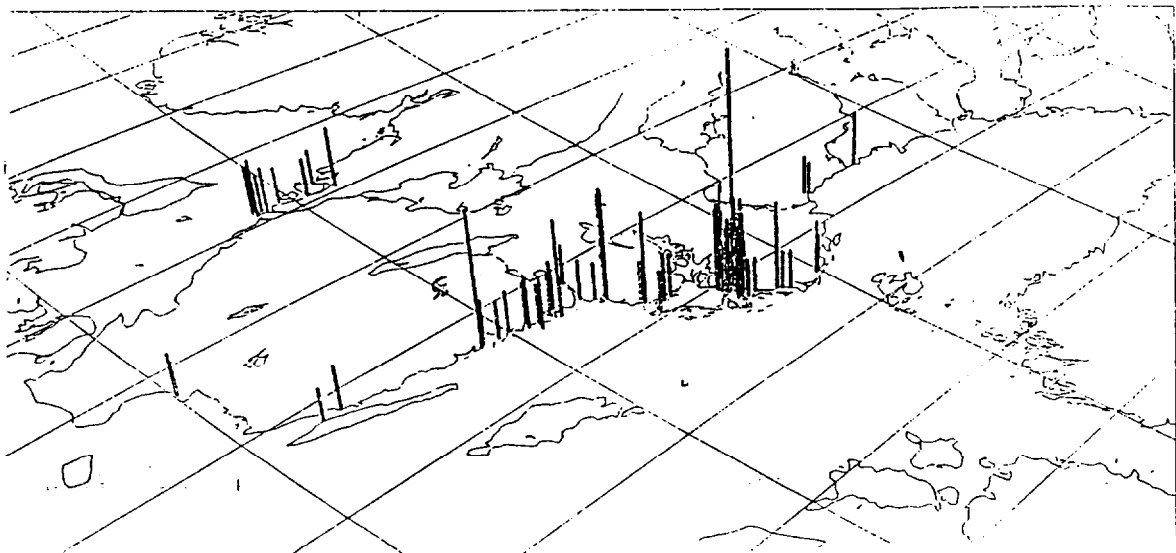

From the Gulf of Bothnia a few coastal areas are reported from the southern Bothnian Sea (inner bays of the Gävle and Söderhamn) with chlorophyll levels higher than 4 mg/m^3 during late summer (Figure 19), which is about twice the concentrations noted in the open waters (Persson, 1993). Oxygen deficits are observed in some coastal areas along the central Bothnian Sea in connection with discharges of organic matters from pulp and paper industries in rather local and isolated water bodies.

Along the coast of the Baltic Proper the winter values of nitrate are generally higher than in the open waters, especially in the Stockholm archipelago but also in some other areas. Compared with the open waters, higher concentrations of phosphate are not as obvious. Increased levels of total phosphorus and nitrogen in late summer are found mainly in coastal areas with limited water exchange (Figure 20).

Figure 20. Increased concentrations of total nitrogen and phosphorus during late summer along the Swedish coast in relation to open waters. A) N-quotient > 1.5 the level of open waters ($250 \mu\text{g tot N/l}$) showing an obvious increase, B) areas with **total-P** quotient > 3 times the typical for open waters ($10 \mu\text{g/l}$ in Bothnian Bay and $15 \mu\text{g tot. P}$ southwards) (Persson, 1993).

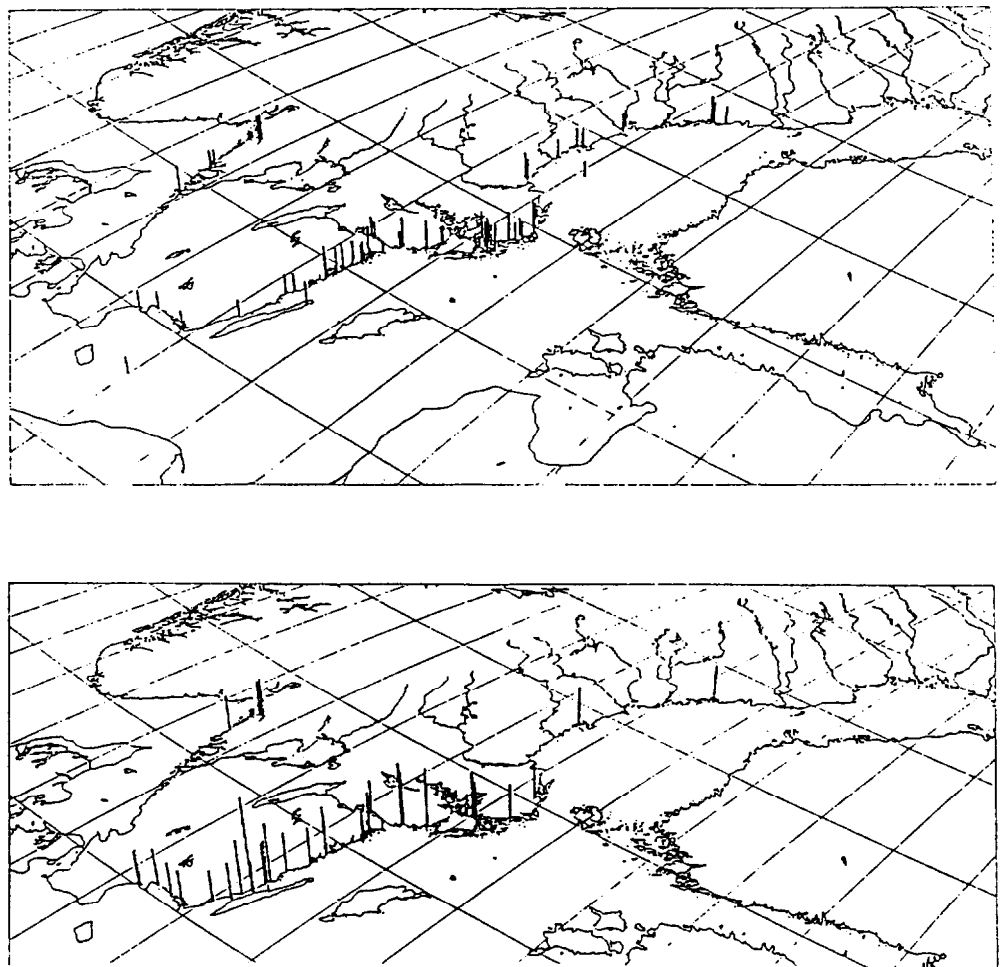

The concentration of chlorophyll with more than $10 \mu\text{g/l}$ can be found in 15 coastal areas along the Swedish coasts; all of them situated along the Baltic Proper. The oxygen conditions mainly depend on the productivity in spring (cf. Persson, 1991) and about 20 fjords/bays are reported along the Baltic coast with oxygen concentrations lower than 3 mg/l at the bottom areas. Again the Stockholm archipelago is the most affected. The area of “dead” bottoms today covers about 48 km^2 compared to about 67 km^2 during 1973-1986, estimated by the absence of benthic macrofauna (Persson, 1993).

The increase of biomass in zoobenthos reported for bottoms above the halocline between 1920s and 1970s (Cederwall & Elmgren, 1980) has continued into the 1980s without any changes in dominance and species composition (Cederwall, 1990).

Recipients studied since the early 1970s indicate a trend of improved conditions reflected by the benthic animal communities (Cederwall & Larsson, 1988, SNV 1988). Among 45 local areas studied during the 1970s from the Bothnian Bay to the Sound, improved environmental conditions were observed in 15 areas, worse conditions in 6, no specific changes in 4 areas and no reliable material from 20 areas. During the 1980s the general trend of improvement continued, with better conditions in 13 areas, worse in 2, no changes in 3, and question marks for 27 areas.

Poor oxygen conditions have been reported to occur in the deeper northern part of the Sound and in southern Kattegat, e.g. in the Bays of **Skälderviken** and Laholm. The first signs of eutrophication, e.g. in the Laholm Bay, was observed as an increase of filamentous algae since the 1960s (Wennberg 1987) followed by an intensified frequency of plankton blooms since the 1980s and mass occurrence of *Chrysochromulina* in 1988 (Lindahl & Rosenberg, 1989). The consequence is an increased frequency of low oxygen concentrations resulting in elimination of benthic organisms, including economically important species like Norway lobster in the Kattegat, and kills or desertion by fish fleeing out from the affected areas (Baden et al., 1990).

3.1.3. Limiting nutrients

The concept of limiting factor includes the pre-requisites for a process where the availability of a vital element is failing and thereby limiting the process. The eutrophication process often centres around primary production and formation of plant biomass. Many elements are essential. In the discussions concerning eutrophication the main important elements are considered to be nitrogen and phosphorus. It should be noted that certain fractions of these nutrients are of interest for plant production, e.g. nitrate and phosphate, and not the amount of totals.

According to the "law of **Liebig**" just one factor at a time and its concentration is responsible as a minimum factor, e.g. for productivity. This is a simplification of a rather complex co-ordination between a series of factors where not only the concentration of a single nutrient but the relationship between concentration levels of various nutrients is of importance. One example is the nitrogen fixation by the cyanobacteria. This question is discussed, among others, by Karlgren (1978).

The export of inorganic nitrogen and phosphorus from the Baltic Sea is small compared to external supply or internal biological turnover. This is a strong indication that the primary production is nutrient limited, but does not suggest which nutrient is limiting (Graneli et al., 1990). Besides nutrient load, other environmental factors have been discussed contributing to the eutrophication of the Baltic area. The variations and relationships between meteorological forcing and oceanographic phenomena are described, e.g. by Launiainen et al. (1987). The long-term trend of eutrophication is, however, accepted to be the effect of nutrient excess and anthropogenic sources are defined as pollution (cf. Larsson, 1986, Nehring et al., 1987).

In limnic waters, measures have been taken to hamper the eutrophication process by a reduction of phosphorus, which has given good results. In the early 1970s, it was proposed that nitrogen should be regarded as the main limiting nutrient for marine areas (cf. Waem & Pekkari, 1973). The role of nitrogen and phosphorus in the eutrophication process has been a matter of discussion during recent decades. There is a comprehensive literature available on the subject reflecting the discussions and opinions (cf. Nehring et al., 1987, 1990, Karlgren, 1978, Larsson et al., 1985, Rosenberg et al., 1986, 1990, Söderström, 1988, Elmgren, 1989, Tamminen, 1990).

In the Bothnian Bay, phosphorus is regarded as the limiting nutrient. The Bothnian Sea is regarded as a transition zone to the Baltic Proper. Another large water body where phosphorus seems to be limiting during the whole growing period is the Gulf of Riga (cf. Nehring et al., 1987). For the open waters in general from the Baltic Proper to the Kattegat it is not possible to postulate, with accuracy, a single nutrient as being responsible for eutrophication. Reports give evidence of fluctuations, e.g. between seasons especially in coastal areas, even if nitrogen is often reported in low concentrations in summer.

Closer to the coastal zone, the trophic status is higher compared to the open sea, because of the load of nutrients introduced by freshwater and the additional contribution by point sources combined with the direction of the prevailing water currents. Concerning the availability of nutrients, seasonal trends are again observed and a local patchiness which is more pronounced than in open waters. Off large population centres, rivers, and industries like pulp mills, there is also often an overload of suspended organic matter. In many areas this overload of imported, allochthonous organic material is more important for negative effects than eutrophication driven by nutrients and production of autochthonous organic material within the waters.

When looking at the nutrient pattern as a whole there seems to be an increased importance of nitrogen with increased salinity, as indicated above from the Bothnian Bay to the western Baltic Sea, or by gradients in estuaries. It should also be noticed that the salinity along the Swedish coasts is lower at the same latitude or longitude compared to the opposite coastal areas as an effect of the large amounts of freshwater from the northern rivers and the anticlock-wise water currents.

The initial position for phytoplankton blooms in spring is important for the conditions in benthic areas during the rest of summer, e.g. the availability of organics as food for the bottom fauna or load of interest for oxygen conditions. There are many coastal areas, especially in the southern and western part of the Convention area, where nitrogen is reported to be the limiting factor. In some others, phosphorus is reported to be the key element.

There is a general excess of nitrogen compared to phosphorus in winter/early spring along the Swedish coasts in relation to open waters (Persson, 1993). During this season, phosphorus is indicated as limiting close to the mouths of rivers in the Laholm Bay and in Darss-Zingster Bodden (Graneli et al., 1986, 1988). In Polish waters complete phosphate utilization is recorded in areas where eutrophication is most intensive during vernal and autumnal phytoplankton blooms, and phosphorus appears to have taken over the role of limiting nutrient in the Pomeranian Bay in spring (Trzosinska, 1992).

Morphometry of the coast might also be of relevance, e.g. at the northern and southern coast of the Gulf of Finland, where the ratio of inorganic nitrogen and phosphorus in winter, given by **Pitkänen** et al. (1987) and **Suursaar (1992b,1993)**, indicate nitrogen as being more important for eutrophication along the Estonian open coasts than along the northern Finnish coast. The weight ratio of inorganic N/P is estimated to 3.5-5.5 for the Gulf of Finland which is somewhat higher than in the Baltic Proper. In the Estonian part of the coastal areas the ratio varies widely from 3.2-12 and in the Finnish part **10-30** was general in coastal waters. For comparison the ratio in the northern part of the Gulf of **Riga** was reported to vary between 8-12.

In this context, it is necessary to underline the gap in basic knowledge concerning the mechanisms and relationships between concentrations of nutrients and responses by algae, based on physiological differences between species in various salinities or whatever reason.

Improved conditions by effective removal of phosphorus, e.g. by treatment plants, are reported from local brackish waters. Examples are the inner parts of the Stockholm archipelago (**Brattberg, 1986**) and the nearby **Himmerfjärd** area treating effluents from 250 000 people (**Elmgren & Larsson, 1987**). A parallel is reported from Finland by, e.g. **Pitkänen** et al. (1991) for the Helsinki region (800 000 people) and the inner Archipelago Sea close to Turku (200 000 inhabitants). The reduced load has resulted in an extended period of phosphorus as possibly limiting nutrient in a series of Danish coastal areas (**Ærtebjerg et al. 1992**).

The discussion should be expanded to conditions and reactions during summer and autumn, when nitrogen compounds available for primary production are consumed or leaving the system by a denitrification. In marine areas regarded as nitrogen-limited, cyanobacteria blooms are often reported which fix and import nitrogen into the system. They are frequent in the Baltic Proper but not usually observed in the northern and western parts of the Convention area. The nitrogen-fixing blue-green algae, which are described as the second main cause decisive for eutrophic conditions, including oxygen deficits reported from many areas, are limited by phosphorus. Reasons for and the magnitude of this fixation in the nitrogen budget are discussed, i.a. by **Larsson et al., 1985**, **Niemistö et al., 1989**, **Graneli et al., 1990**, **Persson 1993**.

The conditions and trends described concerning the question of limiting nutrients and the obvious variability in space and time underline the need for further information/consideration. The reactions of the open basins to measures taken are slow and of a dimension in time which is difficult to even intimate. The time scale in coastal zones for a positive answer on reduction of an external load of nutrients or organic matter is substantially shorter; maybe within a decade. The convincing evidence of the multiple but already **conceptualized** causal connections makes efforts to attack the coastal eutrophication problems more promising. This means an advantage both for the direct contact zone between man and sea and, in a long run, for the quality of the open basins. However, for the long-term approach on nutrients it is vital to get a better basis of knowledge for decisions, taking into account not least the cost/benefit aspects.

3.2. Some secondary effects

This subchapter deals with light penetration in water as an effect of eutrophication, the consequence for benthic vegetation and aspects on toxic blooms. For many observed changes in the structure and function of ecosystems it is difficult to distinguish between various active agencies. This is obvious especially in areas affected by a complexity of environmental disturbances, e.g. close to urban or some industrial centres. For effects on high organizational levels in the ecosystem, e.g. at the fish community level, the reactions are distinct and taken up the subchapter on "Fish and fishery". Direct reference to a single factor is, however, always difficult to discern at all levels, including the interpretation of direct and indirect cause/effect relationships.

3.2.1. Light climate

The transparency of the sea water has successively decreased in the main water areas as an effect of eutrophication and the increased turbidity of the waters. This development is described in the open sea as well as in archipelagoes in more or less general terms.

Long-term changes in transparency are reported by Launiainen et al. (1990), comparing observations from 1914-1939 and 1969-1986 in the northern Baltic Sea. The results show a pronounced decrease of about 2.5-3 meters since the first half of the century. The distribution has also become narrower with very rare notations today of Secchi depths in excess of 14 meters.

The same tendency is demonstrated by direct measurements over time at the Polish and Swedish coasts of the Baltic Proper.

The extensive time series from Poland cover a period from 1957 to 1990 and two kinds of areas; the semi-enclosed Gulf of Gdansk and the Pomeranian Bay plus the open coastal areas. The results from Secchi disc readings have been revised and presented for this report by Trzosinska (1992b).

In general the light climate is limited in the bays; the lowest readings starting at almost zero during the whole period. In the open coasts the lowest values measured are within the range of 3-5 meters. The maximum values observed have also decreased during the period, e.g. from 21 to 16 meters in the Gulf of Gdansk (Figure 2 1).

In all regions the modal values of transparency have decreased by about 3-4 meters during 1957-1990 (Table 1). The lowest Secchi depths are always recorded in the Gulf of Gdansk, where signs of eutrophication were noted already in the 1950s (HELCOM, 1987). In the 1960s and 1970s the deterioration of transparency was also faster in this area compared to all the others. In the Pomeranian Bay as well as in the open sea, drastic changes in the water transparency began mainly in the 1980s.

Figure 21. Frequency distribution of Secchi depths in Polish waters. Calculated for different periods during 1957-1990 in 2m wide classes (Trzosinska, 1992b).

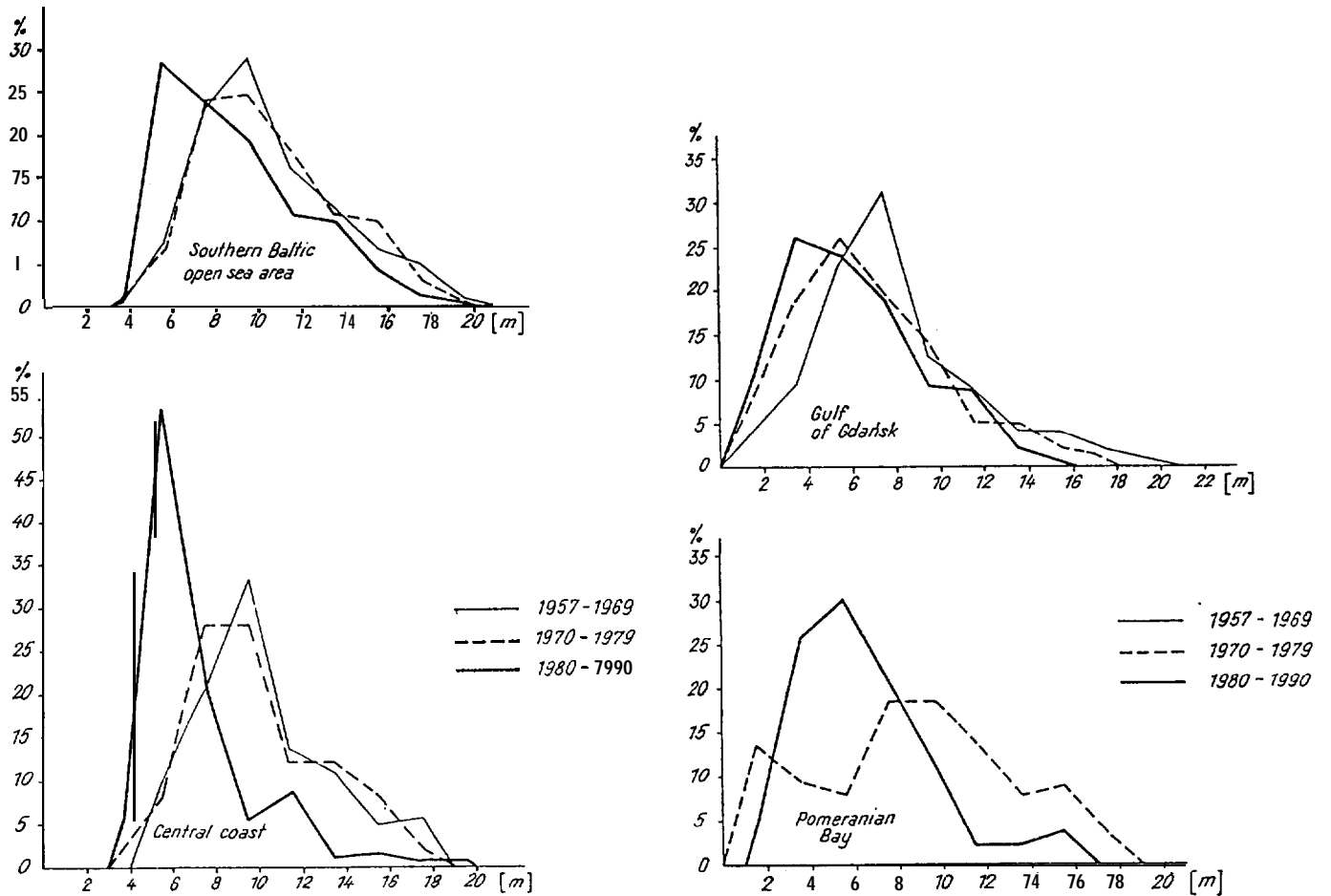

Table 1. Modal values of Secchi disc readings (m) in the southern Baltic Proper.

Region	1957- 1969	1970- 1979	1980- 1990	Overall decrease
Gulf of Gdansk	7.6	6.0	4.7	2.9
Pomeranian Bay	(8.5)		5.7	3.3
Central Polish coast	9.8	9.0	6.2	3.6
Open sea areas	9.6	9.2	6.7	2.9

The results also point to a seasonal fluctuation in light climate, associated mainly with the plankton vegetation cycle. As a rule the winter values are higher, with the exception of areas in the vicinity of the river mouths. At the Gdansk Deep (Stn BMP L1) negative trends were found for all seasons, but they were statistically significant only for the warm, productive, months (Table 2).

The conclusion is that in the Gdansk Deep area the light climate is mainly affected by the autochthonous products of eutrophication, while the situation in the vicinity of the river mouths is affected mainly by allochthonous substance, e.g. suspended material such as river-borne suspended matter and humic substances.

Table 2. Long-term trends of water transparency at the Gdansk Deep, 1957-1990

Period	Mean trend coefficient m/year	Correlation coefficient	Significance level *	Overall trend, m
1957-1990	- 0.074	- 0.31	0.92	2.5
October-March	- 0.033	- 0.15	< 0.90	1.1
April-September	- 0.086	- 0.41	0.98	2.8

* = according to Student's *t*-test

Routine measurements of light climate have also been performed at the Swedish east coast since 1963. One area in the central part of the Baltic Proper is of special interest, considered not affected by local pollution and used as a background and reference area in the national monitoring programme.

The development over time in this area corresponds in principle with the Polish observations; the transparency declining from about 10 meters in 1963 to 5 meters in 1989 (Figure 22). The negative trend is considered to be an effect of the successive eutrophication of the Baltic Proper (Neuman et al., 1988).

Figure 22. Measurements of Secchi depths in a Swedish coastal area at the Baltic Proper (lat. 58° N), unaffected by local pollution. Solid line shows mean values per year; dotted line represents 5-year moving average for the period 1963-1989 (Neuman et al., 1988).

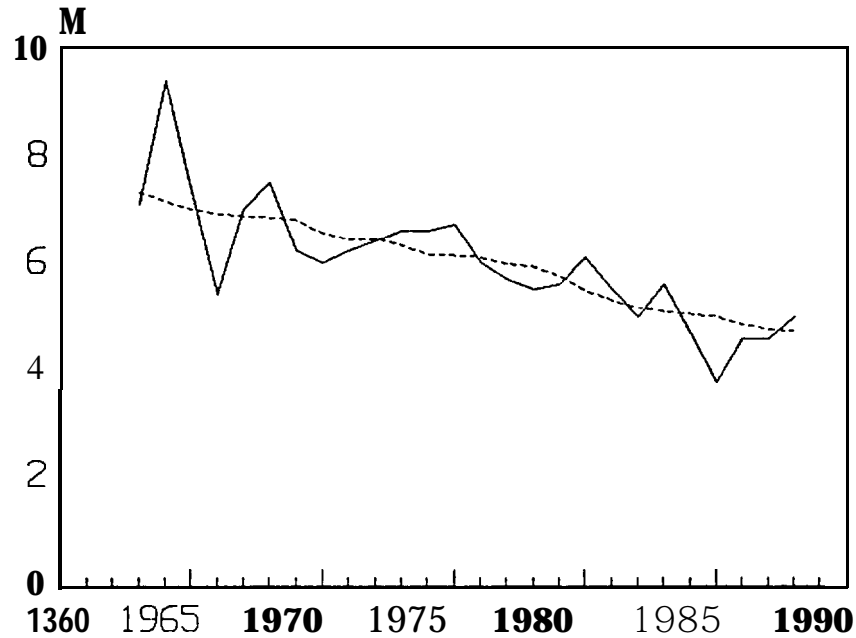

The regional variation of transparency observed along the Swedish coasts is affected by several factors, e.g. concentrations of algae, humic matter and suspended material. Thus, there is no absolute correspondence to be expected between eutrophication and transparency. A transparency lower than 2.5 meters, which negatively affects the recreational value of the coast among other things, has been recorded at 17 local areas, including all water areas except the Bothnian Bay, where transparency is affected by large river inlets (Persson, 1993).

A direct, regional correspondence between the content of chlorophyll-a and Secchi depth is reported by Germany from ten stations in the coastal waters of Mecklenburg and Vorpommern (Figure 23). There is a clear relationship between the trophic grades and the hydrographic-morphological conditions as well as the eutrophication of the different areas (Brüggemann & Bachor, 1990).

The reversed expression of the same mechanism is noted in the northeast Gulf of Finland, where an increased transparency leads to a rapid depletion of inorganic nutrients by phytoplankton. This generally causes increased phytoplankton biomass and leads to an increased sedimentation rate of this biomass within the region and a decrease in the further transport of nutrients.

Figure 23. Mean chlorophyll-a concentrations and mean Secchi depths (1984-1988) in coastal waters of Mecklenburg-Vorpommern.

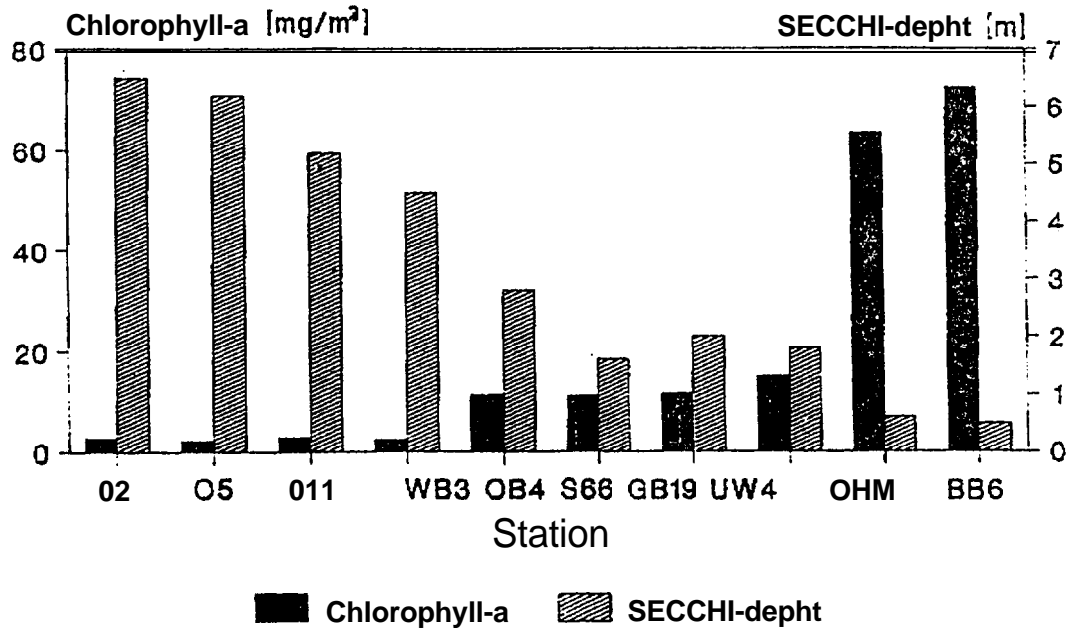

Stations:

outer coastal waters: O2=Lübeck Bay, O5 =north Warnemünde, 011 =east Rügen, OB4=Oder Bay

inner coastal waters: WB3=Wismar Bay, S66=Stralsund, GB19=Greifwalder Bodden, UW4 = Unterwarnow , OHM = Oderhaff, BB6 = Barther Bodden

3.2.2. Benthic vegetation

Benthic vegetation, especially the macroalgae along the coasts, is utilized in many countries as indicators of environmental changes. Long-term observation series are available for the estimation of trends. Two main processes are observed; the change in species composition, biomass and areal density, and the depth range of the vegetation zone.

The littoral vegetation reacts to various pollutants; from specific industrial discharges to a complexity of waterborne elements close to municipal centres. Algae also reflect the occurrence of many elements by bio-magnification. For that reason they are frequently used as indicators of the occurrence of various elements in the water media, e.g. radionuclides and stable metals. Examples are given in Chapter "Metals", Table 11, which underlines the importance of diatom algae as indicator organisms.

The understanding of cause/effect relationships between vegetable growth and discharges of specific substances is limited. As an example it can be mentioned that the nutrient is considered to be responsible for the eutrophication process in the Baltic waters. The general effects of eutrophication are, however, to a certain extent understood, e.g. via long-term changes in the light climate of the waters.

The brown algae *Fucus vesiculosus*, or bladderwrack, together with *F. serratus* in the southern Baltic Proper, belong to the most important algae of the shallow waters in the Baltic Sea and are often used as indicators of water conditions along the coasts. A salinity below about 3 permille is, however, critical for the occurrence of *Fucus*, which sets the limits of its natural distribution in estuaries and northwards in the Gulf of Bothnia.

Figure 24. Status of the *Fucus* communities in areas from which information was available up to 1984 (von Wachenfeldt et al., 1986).

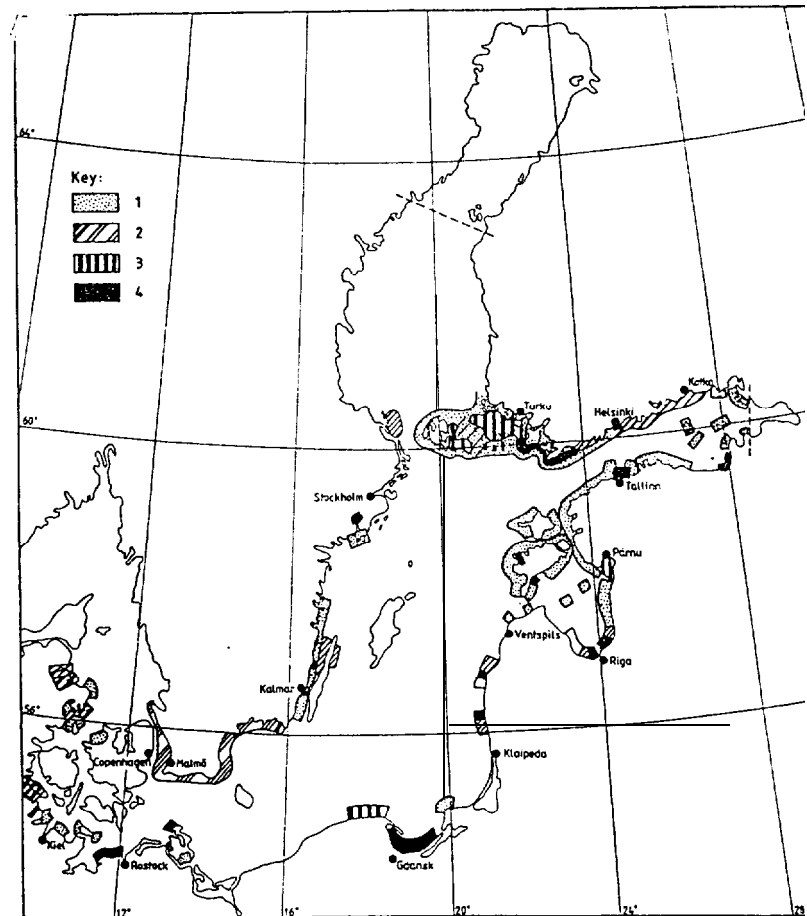

A schematic map of the present status of the littoral communities in the Baltic Sea expressed as changes in *Fucus* spp. in areas from which information has been available.

- 1, *Fucus* growing well and no changes observed
- 2, *Fucus* has slightly decreased
- 3, *Fucus* decreased and patchy
- 4, *Fucus* has declined strongly or disappeared

The map does not show the increase of filamentous algae observed in most of the areas from which changes in *Fucus* have been reported.

Note that the symbols are not in scale.

The thick lines indicate the distribution limits of *F. vesiculosus* in the north and east.

Changes in the *Fucus* communities of the Baltic coastal waters have been reported, e.g. by von Wachenfeldt et al. (1986), and a summary is given in Figure 24. This overview covers a period up to 1984, after which the situation has changed. Information from this and other surveys and from the national reports and contact persons in the Assessment Group is given in the text.

*

A decrease of *Fucus* has been demonstrated along the **Swedish shores** of the **Sound** and **southern Baltic Proper**, including **Gotland**, in both unpolluted and locally polluted areas. Negative effects of discharges from the pulp and paper industries, e.g. at the Swedish eastern coast, have been evident and have led to changes in the production processes.

In the **Swedish southern Bothnian Sea** the lower limit of the bladder-wrack has risen from about 12 to 8 meters from the 1940s to 1984 and the depth of the maximum biomass from 5 to 3 meters (Figure 25). This is considered to be an effect of eutrophication (Kautsky et al., 1986).

Figure 25. *Fucus vesiculosus*. Percentage of bottom area covered in different depth intervals and SE of means, compared between 1943/44 and 1984 (Kautsky et al., 1986).

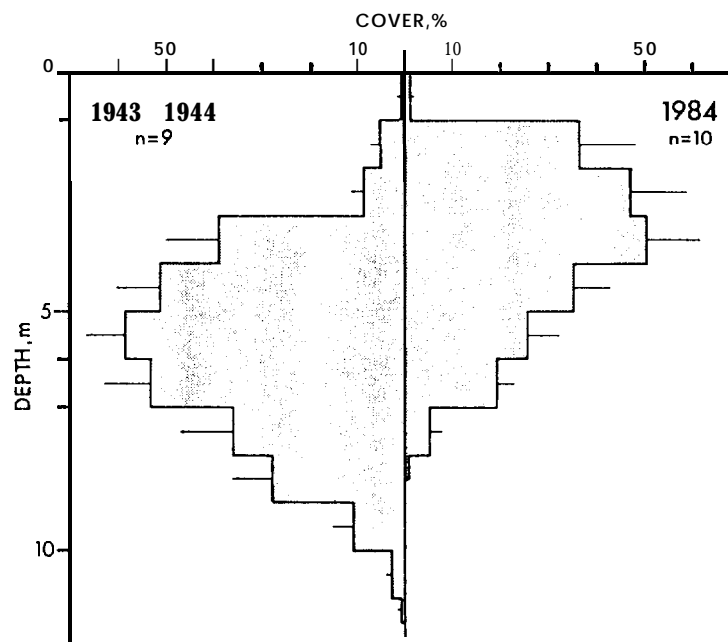

*

A specific case is reported from the archipelago off **southern and southwestern Finland** where *Fucus* declined strongly in the 1970s and early 1980s in parallel with the increased production of, e.g. **filamentous** and planktonic algae. The changes were most evident in the outer archipelago and far from local pollution sources (Kangas et al. 1982). In general, the increase of nutrients in the Baltic water masses was considered to have caused the initial change. Recent observations indicate, however, a recovery of **the *Fucus*** community (Kangas & Niemi 1985).

*

In Estonia, the macrophytobenthos of the Narva Bay has completely disappeared, which is most likely due to the immediate effects of industrial waters. In the Tallinn Bay the areas covered by *Fucus* have been considerably reduced and the bottom vegetation of the northern part of **Pärnu Bay** is suffering from poor light conditions with decreasing areas of vegetation. In the shallow coastal waters of all bays investigated, e.g. in Matsalu and Haapsalu Bays, the role of green algae like *Cladophora glomerata* has substantially increased within the last 15-20 years.

*

Figure 26. Changes in biomass of *Furcellaria* from 1981 to 1987 in the coastal area Pape- Liepaja, Latvia (Korolev et al., 1990).

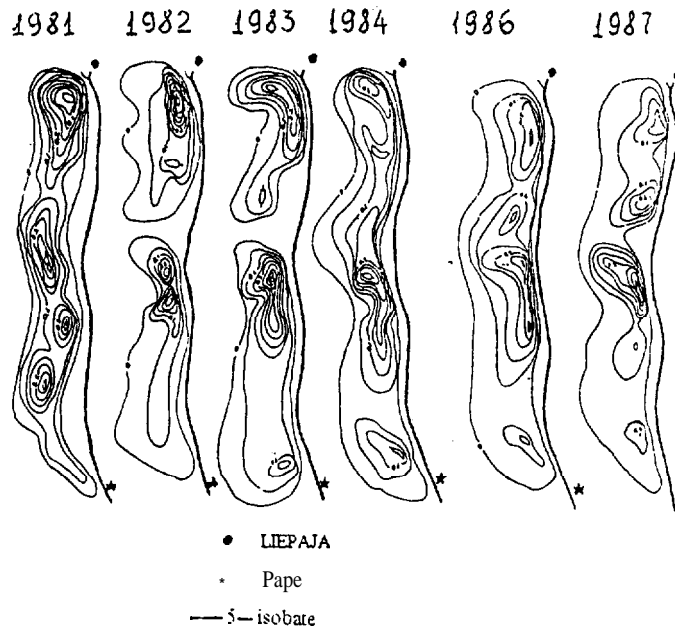

In the eastern **Baltic coastal waters**, monitoring by video technique has been carried out by **LATFRI** from 1982 to 1991 at 280 stations in coastal areas of Estonia, Latvia, Lithuania and Kaliningrad. The main object of investigations is the distribution and biomass of the red algae ***Furcellaria lumbricalis***.

Some data are available from the data bank of video information on the eastern Baltic waters (Korolov et al. 1990). An example is given in Figure 26, which shows the changes in the spatial distribution of biomass (**kg/m²**) of ***Furcellaria*** between 1981 and 1987 and the blue mussel ***Mytilus edulis*** in 1987 in the Pape-Liepaja section. The study includes 182 stations over an area of about 500 **km²**. The results indicate a successive decrease in the biomass and coverage of the red algae over the bottom areas.

In the region of Klaipeda-Ventspils the maximum biomass of ***Furcellaria*** decreased from 1.5 to 0.3 **kg/m²** between 1981 and 1989, the depth distribution of the maximum biomass changed from 10-12 to 8-10 meters and the maximum coverage of benthic area by the algae decreased from 100 to 30%. The total biomass decreased from 86 000 to 13 000 tons between 1978 and 1990 in the same area.

It should be mentioned here that the reduction of the benthic vegetation has a definite negative effect on the success of spawning of herring along the coast. The egg masses in the bottoms covered by algae are well ventilated and survive while very few eggs hatch when laid over naked bottoms. Spawning grounds are now practically non-existent in the Kaliningrad area, along the Lithuanian coast and in the Ventspils region. Natural spawning grounds have remained only in the above mentioned Pape-Liepaja area at the Latvian coast (Korolev et al., 1993).

It should also be noted that a decrease of ***Furcellaria*** was determined in the Klaipeda-Ventspils region after an accident with an oil tanker close to Klaipeda in December 1981 (cf. Chapter 4.2.).

*

Also **in Poland** in the western part of the Gulf of Gdansk (Puck Bay) the biomass of ***Furcellaria*** dropped successively between 1957 and 1979, e.g. from 3000 to 5 **g/m²** (Plinski, 1992). The effect of harvesting in former times is not known but it can be noted that even other representatives of phytobenthos like the characeans have decreased by more than 90% during the same period. The changes between 1977-1984 are given in Figure 27.

There has been a loss of about 40% of species in the Gulf of Gdansk over the past 70 years and a drastic restriction of the depth range from 25 meters at the beginning of the century to about 6 meters at present.

Fucus has disappeared from most of the shallow parts of the Gulf of Gdansk. In the open coastal areas this brown algae is in poor condition compared with green algae like ***Enteromorpha*** and ***Cladophora***. However, in 1990 there was a slight increase in the number of ***Fucus*** thalli washed up on the shore, particularly in the eastern part of the Gulf.

Figure 27. Changes in the phytobenthos community structure in Puck Bay from 1977 to 1984 (biomass in g/m², dry weight) (Plinski, 1992).

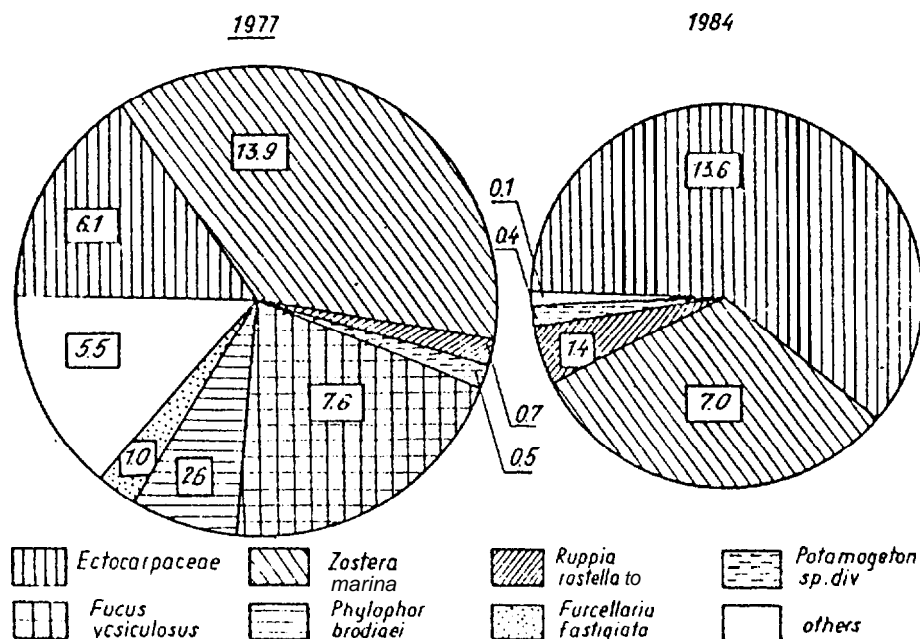

*

In the **Kiel Bay** the biomass of benthic algae was doubled above 12 meters depth and decreased to a fourth below the same depth between the 1960s and the 1980s (Breuer and Schramm, 1988). The extensive population of the red algae *Furcellaria* has been replaced by species of *Phyllophora* and *Phycodrys*.

*

In the inner **waters of Denmark**, observations exist from the 1850s and more frequently since the early 1900s. The general picture is the same as in other coastal waters of the Baltic; a reduced depth range of the benthic vegetation and a change in species composition from perennial to annual species (Ærtebjerg et al., 1992).

During this century, until 1980, the depth limit of the vegetation belt of *Zostera* is reduced from 8-10m to 4-7m in the Great Belt and for macroalgae from 35 to 12 meters. Rocky banks in the open sea areas of, e.g. the Great Belt and Kattegat, which are valuable reference areas for coastal zones, show a general reduction of the brown algae *Fucus serratus*, which was important in the beginning of this century. Algae favoured by eutrophication have increased in all areas, e.g. species of *Cladophora*, *Chaetomorpha*, *Ectocarpus*, *Pilayella*, *Bonnemaisonia*. Figure 28 demonstrates the occurrence in 1991 of those macroalgae in the coastal areas favoured by eutrophication.

Figure 28. The occurrence of macroalgae, favoured by eutrophication, along the Danish coast in 1991 (Ærtebjerg et al., 1992).

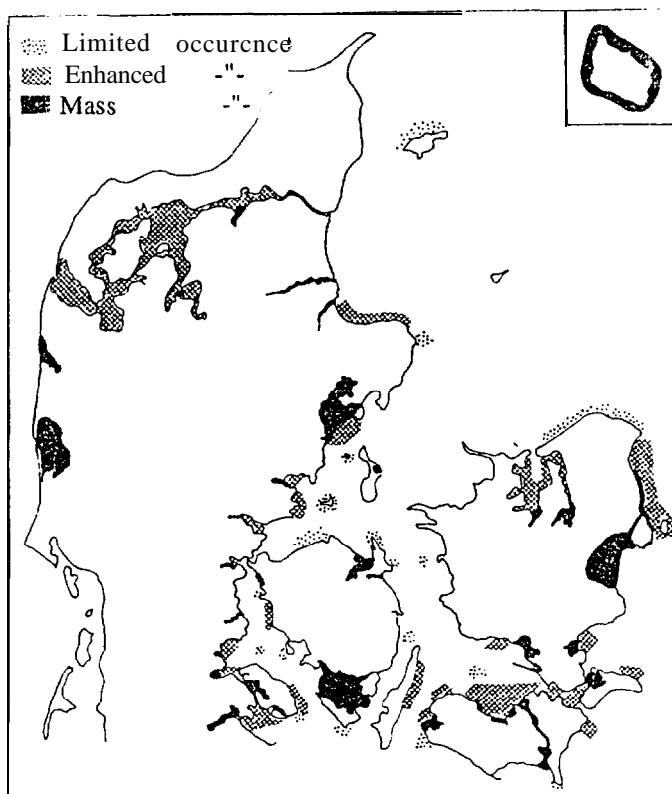

The intense regional surveys during the last decade indicate a changed trend in the development, including a retreat of the biomass and coverage of the annual and opportunistic species, interpreted as an effect of a decreased discharge of nutrients.

*

The changes in the balance, from perennial algae like *Fucus* and rooted plants to annual algae like *Cladophora*, are observed along the Danish as well as the Swedish coasts of the **Kattegat**. One case is the mass occurrence of *Cladophora* in the Laholm Bay in the south-east Kattegat, beginning in the 1970s (Fleicher et al., 1978). This was followed by massive plankton blooms in the 1980s (Rosenberg et al., 1986). The development was leading to serious deterioration of the qualities of the coast in various respects, not least for recreational activities.

In summary, the same processes are reported from all coastal zones around the Convention area - a decline of benthic vegetation, especially in deeper areas and a changed composition of species, e.g. from perennial brown and red algae to the benefit of fast-growing, filamentous green algae. This general trend is related to the overall eutrophication of the waters and the deterioration of the light climate. In local areas the changes are accentuated by discharges of various types of pollutants with negative effects on the environment.

3.2.3. Toxic blooms

Besides the various negative effects of large algal blooms, e.g. effects on the light penetration in water, or demands of oxygen for decomposition, some algal species have directly toxic effects on other organisms. Such toxicity is observed in connection with exceptional blooms of certain species and is more often recorded from the western water areas than in the Baltic Sea.

In the Kattegat and the Danish waters, exceptional phytoplankton blooms often consist of dinoflagellates, chrysophyceans and prymnesiophyceans. These groups are also represented in the Baltic Sea where, however, the cyanophyceans predominate. Within the diatom group, which forms the largest biomasses in the whole water area, only a few toxin-producing **taxa** are known so far.

Interest in and knowledge of toxin-producing algae has increased during the last decade. Difficulties still exist in performing adequate analyses of the toxins, determination of some organisms and, not least, in conducting rapid and contemporaneous sampling of algae and the organisms presumably affected by algal toxins. The death of about 1000 **seabirds** in eastern Gulf of Finland in 1992 has strong similarities with mass mortalities resulting from algal toxins (Kauppi, 1993) and exemplifies the need for routine monitoring if direct evidence is of interest.

In the following the disposition of the subchapter prepared by Willén (personal communication) will follow the taxonomy of the algae with comments on occurrence, effects, etc. complemented by information made available through various national contacts.

Bacillariaceae (diatoms)

Among the diatoms producing toxins can be mentioned *Nitzschia pungens* which occurs mainly in Kattegat-Arkona area in small quantities but is also found in the open Baltic Sea (Kononen et al., 1991). Another diatom, originally described from Canada, is *Pseudonitzschia (Nitzschia) pseudodelicatissima* blooming in the Danish Lillebelt; an area in which the harvesting of mussels was banned in autumn 1992 because of indications of DSP (Lundholm & Skov, 1993). Simultaneous blooms of the species were observed in the whole water area from the western Baltic including the Skagerrak (Edler, 1993). It was also noted in the Kiel Bay (Hansen & Horstmann, 1993) with no signs, however, of poisoning of marine organisms. Another diatom genera suspected as toxin-producing is *Rhizosolenia*. The knowledge of this group of diatoms is limited and further **taxa** can be expected to be identified as toxic.

Nostocophyceae (cyanophyceans, cyanobacteria, blue-green algae)

Anabaena species, e.g. *flos-aquae (lemmemannii)* and *Oscillatoria agardhii* occur from Arkona Sea to the Bothnian Bay, while *Aphanizomenon jlos-aquae* and *Microcystis aeruginosa* **also are** recorded from the Kattegat area. All these **taxa** have their main distribution in freshwaters but they often develop in large quantities in coastal areas. As an example, the *Microcystis* species, which was first reported in the Szczecin Lagoon in the beginning of the 1970s, has expanded its range ever since (Plinski, 1992). The species mentioned are all toxin-producing and were found to be toxic, e.g. in some samples in 1985-1987 collected at the Finnish southern coast (Sivonen et al., 1989a).

Another blue-green algae is *Nodularia spumigena*, which is noted in all waters up to the Bothnian Bay. In the Baltic Proper it generates huge waterblooms in some summers; documented e.g. by multispectral scanning registration (cf. Öström, 1976). The hepatotoxin of *Nodularia*, nodularin, has recently been characterized by Eriksson et al. (1988) and Sivonen et al. (1989a, 1989b).

Figure 29. Toxicity of the cyanobacterial bloom samples in the Gulf of Bothnia and Gulf of Finland during 9-25 August 1990 and 20 August 1991 (Kononen et al., 1991).

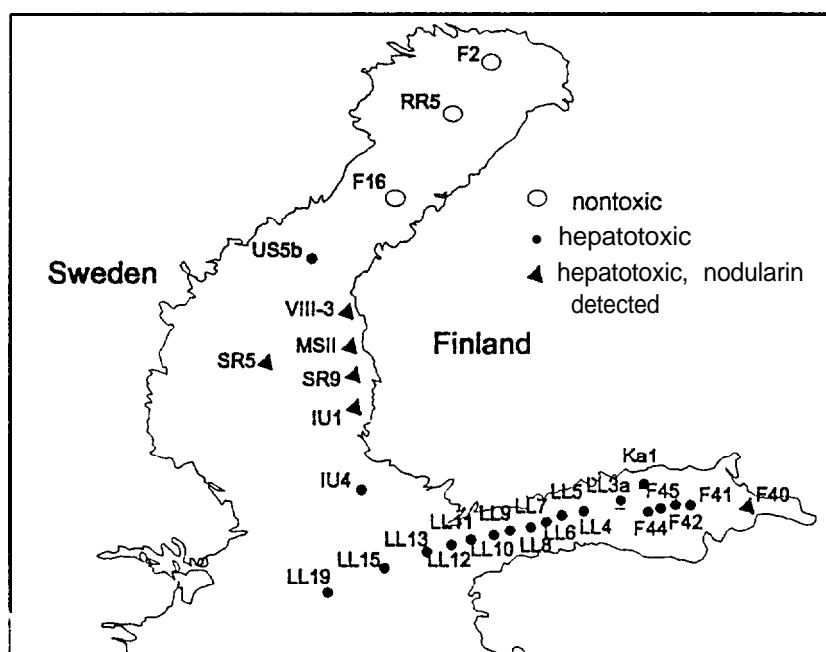

The distribution of toxic blooms of cyanobacteria in Finnish waters has been shown by Sivonen et al. (1989a). For late summer 1990-1991 Kononen et al. (1991) demonstrate the situation in the Gulf of Bothnia and Gulf of Finland (Figure 29). The blooms in the Gulf of Finland were dominated by cyanobacteria, e.g. *Aphanizomenon jlos-aque* and the dinoflagellate *Dinophysis acuminata* and were hepatotoxic. The dominating species in the Gulf of Bothnia was *Nodularia*. The samples in this area and close to St. Petersburg contained nodularin toxin. To these cases can be added areas with *Nodularia* blooms along the Swedish coast of the Baltic Proper and Gotland, during a summer bloom in the Gulf of Riga 1983 (Astok & Suursaar, 1991), in the Gulf of Gdansk during summer (Plinski, 1992) and Gderhaff, southeast of Fehmam and in the Kiel Bay along the German coast (Göbel & Voss, 1990).

Nodularia has been reported to be toxic to fish, birds and mammals (cf. Horstmann, 1975). Several cases of mortality have also been reported, e.g. dogs at the Swedish coasts (Lind et al., 1983, Lundberg et al., 1983), cattle at Stralsund in Germany in early 1980s (Voss, pers. communic.) and heifers in the Gulf of Riga (Astok & Suursaar, 1991).

Dinophyceae (dinoflagellates)

Several species produce toxins that can be concentrated by shellfish and result in DSP (diarrhetic shellfish poisoning) or PSP (paralytic shellfish poisoning) when consumed by man. The problems are mainly concentrated to the Kattegat and the Danish **Limfjorden** and **Lillebælt** and not to the Baltic Sea. The **taxa** mentioned below certainly occur in the Baltic Sea, mainly northwards up to the **Gotland** basins but have only been observed, however, in moderate cell numbers.

Prorocentrum minimum is observed in mass development in the areas from the Kattegat to **Gotland**, e.g. in Kiel Bay every year since 1983 and in Flensburg Fjord in high concentrations in summer. This species and *P. balticum* have not yet been reported as toxin-producing in these waters.

Dinophysis acuminata is one of the main toxic algae and is recorded nearly every year from the whole area except from the Bothnian Bay. The toxins of the genus, collectively referred to as DSP toxins, have been verified in mussels on several occasions along the Swedish west coast and the Danish waters (**Ærtebjerg** et al., 1991). In the Baltic Sea this species often occurs as dominant and in abundances much higher than those found to be toxic in the western waters (Kononen et al., 1991).

Alexandrium tamarense is one of the classical species causing PSP. It was reported from the Limfjorden and Belt area and its occurrence together with *Dinophysis* is noted to be unusually prolonged along the eastern coasts of Denmark in 1991 (Andersen et al., 1992). Resting stages have been found in the Gulf of Finland (Kononen et al., 1991).

Another potential PSP producer is *Alexandrium ostenfeldii* which is common, though never forming blooms, in the Kattegat area (Moestrup & Hansen, 1988, Hansen & Moestrup, 1992).

Gyrodinium aureolum causes death of fish and invertebrates. The first observations in the HELCOM material are from 1981. The main distribution is recorded from the Kattegat-Bomholm area with sporadic occurrence northwards to the Bothnian Sea. A mass development along the Swedish west coast in autumn 1982 is described by Lindahl(1983) and several incidents are known from Danish waters (Olrik et al., 1984, Bergskov et al., 1990).

Prymnesiophyceae (flagellates)

The genus *Prymnesium* has been observed in the whole area except in the Bothnian Bay. *Prymnesium parvum* is one example of an organism which suddenly forms enormous waterblooms in areas where it earlier has been observed only in single specimens. The species belong to the fish-killing algae and some incidents are reported from the Nordic countries.

In spring 1989 an extreme fish kill of more than 300 tons occurred in Kleiner Jasmunder Bodden in the **Rügen** area as a consequence of mass development of *Prymnesium*. In June 1990 a fish kill was reported from the southern coast of Finland. The same was reported from a small bay in the archipelago north of Stockholm in June 1991 and one year later, in June 1992, a corresponding *Prymnesium* bloom developed in the same area - now, however, covering a large water area and resulting in a considerable mortality among fish.

Closely related to *Prymnesium* is the genus *Chrysochromulina*. The toxic principles of *Prymnesium* have been studied thoroughly. The toxin, hemolysin, has a membrane-disrupting effect and the same is found for the toxin or toxin complex of *Chrysochromulina polylepis*. The harmful bloom in the marine western waters during May-June 1988 initiated numerous special studies and the results are given in a number of publications, e.g. Rosenberg et al. (1988), Estep & MacIntyre (1989), Aksnes et al. (1989), Lindahl & Rosenberg (1989), Nielsen et al. (1990), Kaas et al. (1991).

Very high quantitative values of the genus have been recorded several times in the Kattegat during the last decade with maximum values of 80-100 million cells per litre during May-June 1988. This resulted in mortality among fish and other animals: starfish, sea urchins, spongiae, molluscs, etc. and also among macroalgae.

The genus *Chrysochromulina* comprises about 50 species. The genus is regularly observed in the Baltic Sea even if apparent blooms have not yet been observed. An unusual and short bloom is, however, described from the Kiel Fjord in early June 1990, probably caused by *C. polylepis*. Another exception is a bloom of *Chrysochromulina birgeri* under the ice in the Tvärminne archipelago at the southern coast of Finland (Hällfors & Niemi, 1974). No toxic effects were noticed in these areas. In the Danish Belt and south-eastern fjords of Jutland a bloom occurred in May 1992, probably causing fish kill in fish farms (Hansen et al., 1993). The bloom comprised 6 species of *Chrysochromulina*.

REFERENCES

- Aksnes, D.L., Aure, J., Fumes, G.K., Skjoldal, H.R. & R. Sætre, 1989. Analysis of the *Chrysochromulina polylepis*-bloom in the Skagerrak, May 1988. - Bergen Scientific Centre 89/1, 38 pp.
- Andersen, P., Emsholm, H. & S.D. Jacobsen, 1992. Status over overvågningen af forekomsten af giftige alger og gift i muslinger i danske fjorde og kystnære havsområder 1991. - Foreningen Muslingeerhvervet, 63 pp. (in Danish).
- Andersin, A-B., Lassig, J., Parkkonen & H. Sandler, 1978. Long term fluctuations of the soft bottom macrofauna in the deep areas of the Gulf of Bothnia 1954-1974. - Finn. Mar. Res., 244, 137-144.
- Andersson, J. & U. Grimås, 1977. Växtplankton. - In: Studie av Bråviken och kusten söder om Nyköping, ISBN 91-7488-000-4, 85-91. (in Swedish).
- Anonymus, 1984. NPO-Report. - Danish Environ. Agency, Copenhagen (in Danish).
- Astok, V. & Ü. Suursaar, 1991, The state of the Estonian coastal waters in the 1980s; general conclusions. - In: Balt. Sea Environ. Proc., No. 40, 75-81.
- Astok, V., Hannus, M & A. Jaanus, 1991a. The state of the coastal waters of the Gulf of Riga in the 1980s; general conclusions. - In: Balt. Sea Environ. Proc., No. 40, 84-87.
- Bachor, A., 1988. Sonderuntersuchungen zur Vertikalverteilung hydrographischer, chemischer und biologischer Parameter in den westlichen Territorialgewässern der DDR im August 1988. - Forschungsbericht, WWDK Stralsund, 1-1 1. (in German).
- Baden, S-O., Loo, L-O., Pihl, L. & R. Rosenberg, 1990. Biological effects of eutrophication on the Swedish west coast. - Ambio 19, 113-122.
- Bergskov, T., Larsen, J., Moestrup, O., Sørensen, H.M. & P. Krogh, 1990. Toksiske og potentielt toksiske alger i danske farvande: kontrolforanstaltninger, taxonomi, økologi, toksikologi. - Fiskeriminist. Industritilsyn, København, 200 pp. (in Danish).
- Berzins, V., 1990. Gulf of Riga. - In: Balt. Sea Environ. Proc., No. 35B, 86.

- Brattberg, G., 1986. Decreased phosphorus loading changes phytoplankton composition and biomass in the Stockholm archipelago. - **Vatten**, 42, 141-153.
- Breuer, G. & W. Schramm, 1988. Changes in macroalgal vegetation of Kiel Bight (Western Baltic Sea) during the past 20 years. - *Kieler Meeresforsch., Sonderheft 6*, 241-255.
- Brey, T., 1986. Increase in macrozoobenthos above the halocline in Kiel Bay comparing the 1960s with the 1980s. - *Mar. Ecol. Progr. Ser.*, 28, 299-302.
- Brüggemann, L. & A. Bachor**, 1990. Present state of the Baltic coastal waters off Mecklenburg-Vorpommern, Germany. - **GeoJournal 22**, 185-194.
- Cederwall, H.**, 1990. Zoobenthos, central and northern Baltic Proper. - In: *Balt. Sea Environ. Proc.*, **35B**, 245-257.
- Cederwall, H. & R. Elmgren, 1980. Biomass increase of benthic macrofauna demonstrates eutrophication of the Baltic Sea. - *Ophelia, Suppl. 1.*, 287-304.
- Cederwall, H. & U. Larsson, 1988. **Östersjön** - miljökvalitetsbeskrivning. I. Fria vattnet och mjukbottenfaunan. - **Techn. Rep., Askö Lab. No 4**, 75 pp. (in Swedish).
- Cyberska, B., 1990. Regional assessment of oxygen conditions, Gdansk Basin. - In: *Balt. Sea Environ. Proc.*, No **35B**, 84-85.
- Edler, L., 1993. *Pseudonitzschia pseudodelicatissima* in Scandinavian coastal waters - some additional details. *Harmful Algal News*, No 5, 5.
- Ehrhardt, M. & A. Wenck, 1984. Wind pattern and hydrogen sulfide in shallow waters of the western Baltic Sea, a cause and effect relationship? - *Meeresforschung* 30, 101-110.
- Elmgren, R., 1989. The eutrophication status of the Baltic Sea: Input of nitrogen and phosphorus, their availability for plant production, and some management implications. - Second seminar Visby, Sweden, 1987, 9441. *Balt. Sea Environ. Proceedings*, 30, 12-31
- Eloheimo, K. & H. Pitkänen, 1992. Rehevyyt Suomen rannikkovesissä vuonna 1990. (The trophy in Finnish coastal waters in 1990). - *Ympäristökatsaus* 10, 11-12. (in Finnish).
- Eloheimo, K., 1993. The trophy in Finnish coastal waters in 1991. - *Ympäristökatsaus*, 2, 19. (in Finnish).
- Eriksson, J.E., Meriluoto, J.A.O., Kujari, H.P., Österlund, K., Fagerlund, K. & L. Hällbom, 1988. Preliminary characterization of a toxin isolated from cyanobacterium *Nodularia spumigena*. *Toxicon* 26, 161-166.
- Estep, K.W., & F. MacIntyre, 1989. Taxonomy, life cycle, distribution and dasmotrophy of *Chrysochromulina*: a theory accounting for scales, haptonema, muciferous bodies and toxicity. - *Mar. ecol. Progr. Ser.*, 57, 11-21.
- Fleicher, S., Stibe, L. & T. von Wachenfeldt, 1978. Inledande undersökningar 1976-78 av grönalgen *Cladophora glomerata* i Laholmsbukten. Sammanfattande rapport nr 1. - **Länstyrelsen i Hallands län**. Mimeo 33 pp. (in Swedish).
- Gerlach, S., 1990. Nitrogen, phosphorus, plankton and oxygen deficiency in the German Bight and the Kiel Bay. - *Kieler Meeresf., Sonderheft Nr. 7*, 341 pp.
- Gosselck, F. & H. Rumohr, 1990. Zoobenthos, the Belt Sea. - In: *Balt. Sea Environ. Proc.*, **35B**, 225-236.
- Granéli, E., Schultz, S., Schiever, U., Gedziorowska, D., Kaiser, W., & M. Plinski**, 1988. Is the same nutrient limiting potential phytoplankton biomass formation in different coastal areas of the southern Baltic? - *Kieler Meeresforsch. Sonderh. 6*, 191-202.
- Granéli, E., Granéli, W. & L. Rydberg**, 1986. Nutrient limitation at the ecosystem and the phytoplankton community level in the Laholm Bay, south-east Kattegat. - *Ophelia* 26, 181-194.
- Granéli, E., Wallström, K., Larsson, U., Granéli, W. & R. Elmgren**, 1990. Nutrient limitation of primary production in the Baltic Sea area. - *Ambio*, Vol. 19, No 3, 142-151.

- Grim&s, U., 1991. Coastal Waters. In: "The Chernobyl fallout in Sweden." - Swedish Radiation Protection Institute, 1991, pp. 129-142.
- Grim&s, U. & U. Ehlin, 1975. Swedish studies on combination effects of thermal discharges in the aquatic environment. - IAEA-SM-197/24, 69-81.
- Göbel, J. & J. Voss, 1990. Early warning system for algae in coastal zones of Schleswig-Holstein. Document EC 1/6e/3, Copenhagen, pp. 1-4.
- Hansen, P.J. & O. Moestrup, 1992. The marine dinoflagellate *Alexandrium ostenfeldii*: paralytic shellfish toxin concentration, composition and toxicity to a tintinnid ciliate. - J. Phycol. 28, 597603.
- Hansen, R. & U. Hortsmann 1993. *Pseudonitzschia pseudodelicatissima* in the western Baltic. - Harmful Algae News, No 5, p. 5.
- HELCOM 1990. Second Periodic Assessment of the State of the Baltic Sea Area 1984-1988. -Balt. Sea Environ. **Proc.**, No 35B.
- HELCOM 1991a. Interim Report on the state of the coastal waters of the Baltic Sea. - Balt. Sea Environ. **Proc.** No 40, 96 pp.
- HELCOM 1991b. Airborne pollution load to the Baltic Sea 1986-1990. **Balt. Sea Environ. Proc.** No 39, 162 pp.
- HELCOM 1993. Second Baltic Sea Pollution Load Compilation. - Balt. Sea Environ. **Proc.** No 45, 161 pp.
- Horstmann, U., 1975. Eutrophication and mass production of bluegreen algae in the Baltic. - Merentutkimuslait. Julk./Havsforskningsinst. Skr., 239, 83-90.
- Hällfors, G. & A. Niemi, 1974. A *Chrysochromulina (Haptophyceae)* bloom under ice in the **Tvärminne** archipelago, southern coast of Finland. - Mem. **Soc.** Fauna Flora Fennica 50, 89-104.
- ICES, 1989. Baltic Sea patchiness experiment - PEX 86. - Cooperative Res. Rep., No 163., 1-157.
- Järvekülg, A. & A. Seire, 1985. Long-term changes in the bottom fauna of Tallinn Bay and their causes. - Inst. Zool. and Bot., Hydrobiol. Res. XV, 148-154.
- Järvekülg, A., Kangas, P., Kukk, E., Lassig, J., Niemi, A., Saava, A. & I. Vuorinen, 1988. Changes in the ecological state of the Gulf of Finland from the 1960's to the 1980's. - Gulf of Finland Symposium, Tallinn 1988. (in press).
- Kaas, H., Larsen, J., Mohlenberg, F. & K. Rickardson, 1991. The *Chrysochromulina polylepis* bloom in Kattogat (Scandinavia) May-June 1988. Distribution, primary production and nutrient dynamics in the late stage of the bloom. - Mar. Ecol. Prog. Ser. 30, 151-161.
- Kangas, P., Autio, H., Hällfors, G., Luther, H., Niemi, A. & H. Salemaa, 1982. A general model of the decline of *Fucus vesiculosus* on the southern coast of Finland. - **Acta Bot. Fenn.**, 118. 27 pp.
- Kangas, P. & A. Niemi, 1985. Observation of recolonisation by the bladder-wrack, *Fucus vesiculosus* on the southern coast of Finland. - **Aqua Fenn.**, 15, 133-141.
- Karlgren, L., 1978. **Närsalternas** roll i kustvattnen. - In: **Diagnos Östersjön**, 56-68 (in Swedish).
- Kauppi, L. (ed), 1993. Mass mortalities of seabirds in the eastern Gulf of Finland in spring 1992. - **Vesi- ja Ympäristöhallinnon Julkaisuja**, Nat. Board of Waters and Envir., Finland, 1.5.1993. (in Finnish with an English abstract).
- Kautsky, N., Kautsky, H., Kautsky, U., & M. Waem, 1986. Decreased depth penetration of *Fucus vesiculosus* (L.) since the 1940's indicates eutrophication of the Baltic Sea. - **Mar. Ecol. Progr. Ser.**, Vol. 28: 1-8.

- Kononen, K., Sivonen, K. & J. Lehimäki, 1991. Toxicity of phytoplankton blooms in the Gulf of Finland and the Gulf of Bothnia, Baltic Sea. - Proceedings, Symposium of the 5th international conference of the toxic marine phytoplankton, Island October 1991, 1-5.
- Korolev, A., Kadnikov, V.B., Kuznetsova, T.A., Muravsky, V.I., Nazarenko, A.N. & V.G. Drozdecky, 1990. Research on use of artificial substrates and reefs in the coastal zone of the Baltic Sea. In: Artificial reefs for fishery. Collection of scientific works. - Ministry of Fishery of the USSR, All-Union Scientific Research Institute, Vniro. Moscow. pp 166-177. (in Russian).
- Korolev, A., Kutznetsova, T. & V. Drozdetski, 1993. Features of the Baltic herring's spawning grounds in the South-Eastern Baltic. ICES C.M. 1993/J23, 12 pp.
- Kostrichkina, B., Jansone, B., Kalveka, B. & R. Gaumiga, 1993. The development of phytoplankton and zooplankton in the Gulf of Riga exemplified by data from August. - BMB 13th Symposium, Riga 1993. (in press).
- Kucinskiene, A.A., 1989. Peculiarities of bacterial hydrogen sulfide formation in Curonian Bay and Lake Druksiai (Lithuania). - Abstracts, 9th international symposium on environmental biochemistry, 4-8 September, Moscow, 1-10. (mimeogr.).
- Lagzdins, G., 1990. Zoobenthos, Gulf of Riga. -In: Balt. Sea Environ. Proc., 35B, 257.
- Larsson, U., 1986. The Baltic Sea. In: Rosenberg (ed) Eutrophication of marine waters surrounding Sweden. - Nat. Swed. Environ. Prot. Board, Report No 3054, 16-70.
- Larsson, U., Elmgren, R. & F. Wulff, 1985. Eutrophication of the Baltic Sea: Causes and consequences. - Ambio, 14, 9-14.
- Launainen, J., Matthäus, W., Fonselius, S. & E. Francke, 1987. Hydrography. -In: Balt. Sea Environ. Proc., No 17B, 7-34.
- Launiainen, J., Pokki, J., Vaino, J., Niemimaa, J. & A. Voipio, 1989. Long term changes in the Secchi depth in the northern Baltic Sea. - In: Balt. Sea Envir. Proc., No 35B, 32-33.
- Lind, M. G., Edler, L., Femö, S., Lundberg, R. & P.O. Nilsson, 1993. Risken för algfiirgiftning har ökat. Hundar avled efter bad i södra Ösersjön. - Läkartidningen 80, 2734-2737. (in Swedish).
- Lindahl, O., 1983. On the development of a Gyrodinium aureolum occurrence on the Swedish west coast in 1982. - Mar. Biol. 77, 143-150.
- Lindahl, O. & R. Rosenberg, 1989. Algbloomingen av Chrysochromulina polylepis vid svenska västkusten 1988. - Naturvårdsverket (SNV), Rapport 3602, 71 pp (in Swedish, English summary).
- Lundberg, R., Edler, L., Fernö, S. Lind, M.G. & P.-O. Nilsson, 1983. Algfiirgiftning hos hund. - Svensk Veterinärtidn., 35, 509-516. (in Swedish).
- Lundholm, N. & J. Skov, 1993. Pseudonitzschia pseudodelicatissima in Scandinavian coastal waters. - Harmful Algae News, No 5, p. 4.
- Moestrup, O. & P.J. Hansen, 1988. On the occurrence of the potentially toxic dinoflagellates Alexandrium tamarense (=Gonuaulax excavata) and A. ostenfeldii in Danish and Faroese waters. - Ophelia 28, 195-213.
- Nehring, D., Ærtebjerg, G., Alenius, P., Astoc, V., Fonselius, S., Hannus, M., Tervo, V., Trzosinska, A., Tulkki, P. & Yurkovskis, A.K., 1987. Nutrients. - In: Balt. Sea Environm. Proc., No 17B, 35-81.
- Nehring, D., Hansen, H.P., Jorgensen, L.A., Körner, D., Mazmachs, M., Perttilä, M., Trzosinska, A., Wulff, F. & A. Yurkovskis, 1990. Nutrients. - In: Balt. Sea Environm. Proc., No 35B, 109-152.
- Neuman, E., Sandström, O. & M. Olsson, 1988. Some aspects of the influence of pollution on the quantity and quality of the Baltic Sea fishery resources. - ICES, BAL/No 28, 1-8.

- Nielsen, T.G., **Kiørboe, T. & P.K. Bjørnsen**, 1990. Effects of a *Chrysochromulina polylepsis* subsurface bloom on the plankton community. - Mar. Ecol. Prog. Ser., 21-35.
- Niemistö., L., Rinne, I., Melvasalo, T. & A. Niemi**, 1989. Blue-green algae and their nitrogen fixation in the Baltic Sea in 1980, 1982 and 1984. - Meri 17: 3-59.
- Olrik, K., Krogh, P., Hansen, V., Pedersen, S.M. & G. Ærtebjerg**, 1984. Toksiske planktonalger i danske og **tillstødene** farvande. - Fiskeriministeriet, **Köpenhamn**. 106 pp. (in Danish).
- Ojaveer, E., Erm, V., Järvekülg, A. & J. Tenson**, 1988. On the changes of the **Pärnu** Bay ecosystems during recent decades. - In: Problems of contemporary ecology, Tartu State University. Abstracts of IV conference in ecology, 1988, Tartu, **102**.
- Persson, G.**, 1991. **Växtnäringsämnen och eutrofiering i havet.** - **Naturvårdsverket (SNV)**, Rapport 3694, 47 pp. (in Swedish).
- Persson, G.**, 1993. Eutrofiering; **tillstånd utveckling orsak/verkan.** - **Miljön i Sverige**, 92 (MIST).- In manuscript. (in Swedish).
- Pitkänen, H., Kangas, P., Miettinen, V. & P. Ekholm**, 1987. The state of the Finnish coastal waters in 1979-1983. - Vesi- ja **Ympäristöhallinnon** Julkaisuja, 8, 167 pp.
- Pitkänen, H.**, 1991. Nutrient dynamics and trophic conditions in the eastern Gulf of Finland: the regulatory role of the Neva estuary. - Aqua Fennica 2 1, 2,105-1 15.
- Pitkänen, H., Kangas, P., Miettinen, V. & P. Kauppila**, 1991. The state of the Finnish coastal waters in the late 1980s. - Balt. Sea Environ. **Proc.** No. 40, 37-52.
- Pitkänen, H., Tamminen, T., Kangas, P., Huttula, T., Kivi, K., Kuosa, H., Sarkkula, J., Eloheimo, K., Kauppila, P. & B. Sakalasky**, 1993. Late summer trophic conditions in the northeast Gulf of Finland and the river Neva estuary, the Baltic Sea. - Estuarine, Coastal and Shelf Science. (in press).
- Plinski, M.**, 1992. Vegetation. In: Marine Pollution (2). An assessment of the effects of pollution in the Polish coastal area of the Baltic Sea, 1984-1989. Studia i Materialy Gceanologiczne, Nr 61, 181-189.
- Renk, H.**, 1992. Primary production and the concentration of chlorophyll-a. In: Marine pollution (2). An assessment of the effects of pollution in the Polish coastal area of the Baltic Sea, 1984-1989. - Studia i Materialy Gceanologiczne, Nr 61, 167-180.
- Rosenberg, R., Elmgren, R., Fleischer, S., Jonsson, P., Persson, G. & H. Dahlin**, 1990. Marine eutrophication case studies in Sweden. - **Ambio**, Vol. 19, No 3, 102-108.
- Rosenberg, R.(ed), Larsson, U. & L. Edler**, 1986. Eutrophication in marine waters surrounding Sweden. A review. - Nat. Swed. Environ. Prot. Board, Report 3054, 137 pp.
- Rosenberg, R., Lindahl, O. & H. Blanck**, 1988. Silent spring in the sea. - **Ambio** 17, 289-290.
- Rönnerberg, O., Adjers, K., Ruokolahti, C. & M. Bondestam**, 1992. Effects of fish farming on growth, epiphytes and nutrient content of *Fucus vesiculosus* L. in the **Åland** archipelago, northern Baltic Sea. - Aquat. Bot., 42, 109-120.
- Schultz, S., Leppänen, J-M., Ærtebjerg, G. & U. Horstmann**, 1990. Phytoplankton: chlorophyll-a and primary production. In: Balt. Sea Environ. **Proc.**, No 35B, 156-158.
- Sivonen, K., Kononen, K., Carmichael, W.W., Dahlem, A.M., Rinehart, K.L., Kiviranta, J. & S.I. Niemelä**, 1989a. Occurrence of the hepatotoxic cyanobacterium *Nodularia spumigena* in the Baltic Sea and structure of the toxin. - Appl. Environm. Microbiol., 1990-1995.
- Sivonen, K., Kononen, K., Esala, A-L. & S.I. Niemelä**, 1989b. Toxicity and isolation of the cyanobacterium *Nodularia spumigena* from the southern Baltic Sea in 1986. - Hydrobiologica 185, 3-8.

- SNV 1988. Monitor 1988. Sweden's marine environment - ecosystems under pressure. - Swed. Envir. Prot. Agency, 207 pp.
- Suursaar, Ü., 1992a. On the water quality of the open part of the Gulf of Finland and coastal waters of Estonia. - **Proc. Estonian Acad. Sci. Ecol.**, **2,3**, 93-102.
- Suursaar, Ü., 1992b. The state of the Estonian coastal waters in 1979-1990: seasonal, vertical, and horizontal variations. - **Proc. Estonian Acad. Sci. Ecol.**, **2,4**, 129-136.
- Suursaar, Ü., 1993. The analysis of the water quality in the open part of the Gulf of Finland and coastal waters of Estonia. - Dissert. Geograph. Univers. Tartuensis, 3, 28 pp.
- Söderström, J.**, 1988. Phytoplankton production in coastal waters, a flow-system under "steady state" controlled by phosphorus availability. - **Vatten** 44, 3-10.
- Tamminen, T., 1990. Eutrophication and the Baltic Sea: Studies on phytoplankton, bacterioplankton and nutrient cycles. - PhD thesis. Univ. of Helsinki, Dept. Environm. Conserv. 22 pp.
- Trzosinska, A., 1992a. Nutrients. In: Marine pollution (2). An assessment of the effects of pollution in the Polish coastal area of the Baltic Sea, 1984-1989. - *Studia i Materialy Oceanologiczne*, Nr 61, 107-119.
- Trzosinska, A., 1992b. Water transparency in the Polish zone of the Baltic Sea. - *Gceanologia* 33, 203-209.
- Trzosinska, A. & B. Cyberska, 1992. Oxygen and hydrogen sulphide. In: Marine pollution (2). An assessment of the effects of pollution in the Polish coastal area of the Baltic Sea, 1984-1989. - *Studia i Materialy Gceanologiczne*, Nr 61, 93-99.
- Wachenfeldt, T. von, Kangas P. & Waldemarsson, S., 1986. Changes in the littoral communities along the Baltic Sea coasts. *Balt. Sea Environ. Proc.* No. 19: 394-403.
- Waern, M. & S. Pekkari, 1973. Outflow studies. Nutrients and their influence on the algae in the Stockholm archipelago during 1971. No. 1. - *Oikos*, Suppl. 15, 155-163.
- Weigelt, M., 1987. Auswirkungen von Sauerstoffmangel auf die Bodenfauna der Kieler Bucht. - *Berichte Inst. Meereskunde Kiel* 176, 1-299. (in German).
- Weigelt, M. & H. Rumohr, 1986. Effects of wide-ranged oxygen depletion on benthic fauna and demersal fish in Kiel Bay 1981-1983. - *Meeresforschung* 31, 124-136.
- Wennberg, T., 1987. Long-term changes in the composition and distribution of the macroalgal vegetation in the southern part of Laholm Bay, south-west Sweden, during the last thirty years. - *Swed. Environ. Prot. Agency, Rep.*, 3290, 1-47.
- Willén, T.**, Kononen, K. & U. Horstmann, 1990. Phytoplankton biomass and species composition. - In: *Balt. Sea Environ. Proc.*, No **35B**, 167-198.
- Ærtebjerg, G.**, Fonselius, S., Hansen, H.P., Körner, D. & H. Rumohr, 1990. Regional assessment of oxygen conditions; the Kattegat, the Sound and the Belt Sea. - In: *Balt. Sea Environ. Proc.*, No. **35B**, 75-79.
- Ærtebjerg, G.**, Sandbeck, P., Agger, C.T., **Lundøf, S.**, Kaas, H., Jensen, J.N., Rasmussen, M.P., Pedersen, D.S., Christensen, P.B. & K. Dahl, 1992. Marine **områder**. Fjorde, kyster og åbent hav. (Editor Gunne **Ærtebjerg**) - *Faglig rapport fra DMU*, nr. 61, 1-169. (in Danish).
- Öström, B.**, 1976. Fertilization of the Baltic by nitrogen fixation in the blue-green alga *Nodularia spumigena*. - *Remote sensing of Environm.*, 4, 305-310.

4. HAZARDOUS SUBSTANCES

4.1. Metals

The occurrence of metals in the media and the transfer mechanisms from the media to the biota depends on a series of general features of the coastal zone as discussed in Chapter 2. Of decisive importance is also the physico/chemical form and thereby the behaviour of the metals for the availability and entrance into the biosphere, either directly from water and sediment or indirectly via the food chains and detectable as adsorption or absorption.

4.1.1. Sea water

The two main sources of metals to the sea basins are the air-borne fraction via deposition over the sea surface and the water-borne fraction from rivers and other point sources or diffuse leakage along the coasts. In general the former gives the background for the main basins while the latter often results in gradients from discharges. It should also be pointed out that there is a transport of water-borne elements from sources into the North Sea, via the Skagerrak and Kattegat and further in the Baltic Sea. This is clearly shown, by e.g. radioactive tracers (Grimås 1987).

Input

Of interest is the balance between the natural background and the anthropogenic input of metals into the Convention area, Such an estimation is presented, e.g. by Lithner et al. (1990) and Borg et al. (1991) and presented in Table 3.

Table 3. The quota between anthropogenic load (air- and water-borne) and transport of natural background amounts of metals by rivers into the Convention area (after Lithner 1990).

Area	Cr	Ni	cu	Zn	Cd	Pb	AS	Hg
(Alt. 1)								
Both.B	0.1	0.3	0.6	0.6	0.8	1.5	0.1	2.0
Both.S	0.5	0.4	1.0	2.0	2.5	3.6	0.2	2.0
Balt.Pr	0.1	0.4	2.4	2.3	6.9	7.0	0.3	4.8
west	0.2	0.7	1.1	1.4	3.3	7.2	0.4	4.7
(Alt 2)								
Both.S	0.2	0.4	0.8	1.5	1.6	2.7	0.2	2.6
Balt.Pr	0.2	0.4	1.7	1.9	4.6	5.0	0.2	4.1
West	0.2	0.4	1.7	1.7	4.3	5.1	0.2	4.2

Baltic Proper (Balt Pr): includes Baltic Proper plus the Gulfs of Finland and Riga.

Western waters (West) include the Sound and Kattegat.

The figures represent the quota between anthropogenic load and background input through rivers.

Two alternatives are given; one for each basin with no considerations taken into transport between basins (Alt 1) and the other including a transport of total amounts of metals from the basin “upstreams” (Alt. 2). The true figure should be somewhere between these hypothetical extremes.

The estimations indicate no decisive differences between the two alternatives. There are rather low values for chromium (Cr) nickel (**Ni**) and arsenic (As) in all areas and especially high values for cadmium (Cd), lead (**Pb**) and mercury (**Hg**) for the Baltic Proper, the Sound and the Kattegat. As pointed out in the references there are, however, many uncertainties involved in the background material

A second estimation has been made to distinguish the various fractions of anthropogenic load. The share of atmospheric deposition based on information from various sources has been estimated and also the relation between local airborne emissions and the fall-out over the sea surface (Table 4).

Atmospheric fallout generally answers for more than 50% of the total anthropogenic load of metals to sea areas. Deviations can be seen for arsenic in the Bothnian Bay, chromium and nickel in the Gulf of Bothnia and mercury in the Sound and Kattegat. For the Baltic Proper, two alternatives can be given for data available in 1990 since the data reported for some riverborne inputs suffer from analytical uncertainties. If such data are excluded, the share of atmospheric inputs increases, especially for copper, cadmium and mercury, up to 0.80.

Table 4. The share of atmospheric deposition (A) in the total anthropogenic load of metals (T) and the relation between local emissions (LE) and the fall-out over the sea surface.

Sea area	Cr	Ni	cu	Zn	Cd	Pb	Hg	AS
Bothnian Bay								
A/T	0.25	0.25	0.88	0.60	0.87	0.95	0.50	0.31
LE:A	0.62	0.46	0.33	0.58	0.50	1.5	1.5	3.0
Bothnian Sea								
A/T	0.10	0.36	0.86	0.50	0.85	0.94	0.54	0.77
LE:A	0.10	9.4	1.0	0.25	0.63	0.77	0.50	1.5
Baltic Proper								
A/T	0.97	0.95	0.36	0.56	0.48	0.97	0.50	0.98
The Sound + Kattegat								
A/T	0.66	0.50	0.50	0.56	0.60	0.93	0.40	0.73

A = atmospheric deposition over the sea surface

T = total anthropogenic: waterborne+airborne

LE = local airborne emissions

The importance of local airborne emissions should be observed. Examples from Swedish areas illustrate this, e.g. lead, arsenic and mercury in the **Bothnian** Bay and nickel and arsenic in the Bothnian Sea. These emissions should have effects in nearby water areas off large industrial centres.

Concentration levels

Coastal areas can be selected from information gained in national reports, where the input and levels of metal have been described as problematic. These areas are presented in Figure 66, which is based also on levels in sediments and biota.

The information on concentrations of **metals** in local coastal waters are limited due to, for example, analytical difficulties. Some values for totals and **particulates** are given in Table 5 from coastal areas compared to open sea waters. No problems are indicated by these “background” values.

Values of some metals from affected areas are given in Table 6. Increased concentrations for most metals are reported from the eastern part of the Gulf of Finland and especially in the Neva Bay. Here some occasional values can be regarded as alarming if not a result of analytical uncertainties. In other affected areas the concentrations seem moderate, with exceptions, e.g. near the mouths of polluted rivers or the concentration of mercury reported from the Curonian Lagoon.

For arsenic, which is of interest especially in the Bothnian Bay, sporadic measurements from the beginning of the 1970s show concentrations around 7 $\mu\text{g/l}$ in open waters. In 1975, 2.5 $\mu\text{g/l}$ was noted and in 1987 the corresponding value was 0.65 $\mu\text{g/l}$. This decrease during the last 15 years is a result of the decreased discharges from **Rönnskär**, from about 2000 tons/year in 1967-73 to 10-12 tons in 1985-87. The release to the atmosphere was 110-150 and 12-39 tons/year, respectively.

Table 5. Metals in open sea water and coastal areas.

Area	Total, $\mu\text{g/l}$				Particulate,				
	Balt.Pr.	FI	SE	DE	per gramme	per litre			
Metal					Balt.Pr.	PL*	PL*	PL#	SE
					$\mu\text{g/g}$	$\mu\text{g/g}$	$\mu\text{g/l}$	$\mu\text{g/l}$	$\mu\text{g/l}$
Fe			5-33		8800	8800	53		60
Cr	0.1			0.2		100			
Ni	0.7-0.8			0.6-0.8	70	40	0.23		
cu	0.7-0.8	2-5	1.2	1.0-1.5	145	96	0.59	0.14	0.6
Zn	1.0	5-10	4.7	2-3	640	630	4	1.90	0.7
Cd	0.03	< 1	0.05	0.02	6	13	0.08	0.06	0.008
Pb	0.03-0.08	0.15-1	0.3	< 0.2	180	52	0.3	0.18	0.4
Hg	0.003	< 0.05	0.02	< 0.005	5				

PL * = Bay of Gdansk, PL # = open Polish coast

Table 6. Metals in sea water in affected coastal areas, total $\mu\text{g/l}$.

Areas/Metals	Cu	Cd	Pb	Hg
Background	0.8	0.03	0.05	0.003
Off Oxelösund	1 - 2.4	0.05 - 0.12	0.5 - 1.3	0.02 - 0.03
Neva Bay occasionally	0.4 - 10 30	0.4 - 1.2	4 - 10 50	0.05 - 0.5 2
Vyborg/Koporie/Luga	0.4 - 1	0.4 - 0.8	4 - 10	0.05 - 0.3
Narva/Tallinn Bay				0.01 - 0.14
Gulf of Riga				
Mouth of Daugava	1 - 6	0.01 - 0.4	0.3 - 1.2	0.002 - 0.07
Central part	0.3 - 3	- 0.1	- 0.05	- 0.05
Ventspils/Liepaja Curonian Lagoon	0.4 - 6	0.06 - 0.5	0.1 - 0.8	0.002 - 0.1 0.10 - 0.3
Wamow estuary* off river mouth	0.5 - 0.6	0.03	0.02 - 0.06	0.003 - 0.009
Bodden waters* Germany	0.3 - 4.7	0.005 - 0.24	0.01 - 1.3	0.002 - 0.05

* = dissolved metals

Physico/chemical form and behaviour

The radius of effects in water depends mainly on the physical transport systems and residence times. In a larger scale it is also affected by the **physico/chemical** form. Table 7 describes the properties for some metals in the Baltic Proper and some links between metals in the two media: water and sediment.

Table 7. Appearance and behaviour of some metals in the Baltic Proper: Sediment mg/kg dry weight, water $\mu\text{g/l}$, theoretical residence time (TRT) years, vertical settling rate through water: in meters/year.

	Ni	CU	Zn	Cd	Pb	Hg	As
Surface sediment							
Mean 1)	48	65	348	2.6	72	0.10	15
Medium 1)	46	55	330	1.7	60	0.09	13
Mean 2)	38	49	260	2.0	69	0.28	
Water, totals 2)	0.75	0.8	1.5	0.03	0.05	0.003	0.6 3)
Particulate % 2)		17	17	9	71		
TRT 2)	6	5-6	2	5-6	0.3	3	
TRT 4)		5	2	6	0.4	5	17
Settling rate m/year 5)		12	56	8	155	5	4

1) Borg et al., 1990

2) Briigmann & Hennings, 1984, Kremling et al., 1987

3) Andrae et al., 1989

4) Estimation from above-mentioned levels in surface sediments (1) and in water (2) and the sediment growth/year of 40 million tons dry substance

5) Phosphorus: settling rate 5 meters per year (Wulff, 1989, pers. comm.)

There is an obvious difference between the various metals. The extremes in this set of metals are arsenic and lead; the former with a theoretical residence time in the free water mass of 17 years and the latter with 0.3 years. This affects the possible action radius from a point source, e.g. arsenic from the point discharge in the Bothnian Bay, which in practice can affect the whole Baltic area. The relatively short residence time for zinc compared to metals like copper and cadmium can also be seen, which might depend on separate mechanisms for storage, e.g. by sulphide fixation. Other possible mechanisms are affinities to particulate matters.

It should be pointed out that the residence times for metals discussed above are mainly overall means for a whole water body. They need a careful application at point sources in local areas where a series of environmental conditions might have an influence on their behaviour. The general effect of a predominant water transport system seems, however, to have an overall effect on the fate of metals in the coastal zone (cf. Figure 32).

There is also a correlation between the salinity and the concentration of some metals in sea water. The concentration of cadmium, copper and nickel shows a negative correlation with salinity (Figure 30), which indicates a supply via point sources, mainly the rivers. The conditions may also be affected by effective sedimentation in the Baltic Proper.

The opposite pattern is shown by metals like molybdenum, germanium, uranium and arsenic, which have a general positive correlation with salinity and indicate a supply, mainly from the western marine waters. A deviation from this pattern is seen in the Bothnian Bay, where levels of arsenic in sea water are elevated by emissions from the Swedish **Rönnskär** Works. The effects can be seen at various levels of the system, e.g. in the sediments (cf. Table 9).

Metals like lead, mercury and zinc are on the same levels in the sea water of all areas. This indicates that there are other steering mechanisms than the salinity, e.g. atmospheric deposition, as dominating source factors.

The relation between salinity, **physico/chemical** form and behaviour of metals is important in various geographical dimensions, ranging from the effects outlined above in the main basins to the behaviour and availability of metals in local areas. The conditions in the estuaries outside large rivers are affected by the gradient in salinity. This involves, e.g. increased conformation and sedimentation of Colloids, mainly watery iron- and manganese-oxides plus **humic** substances. The complex background for sedimentation, induced also by increasing **pH**, means a deposition of metals in the river mouths. These metals can be re-mobilized, e.g. by a series of chemical processes or by direct uptake by organisms living in the sediments.

4.1.2. **Sediments**

A general description of the Baltic Sea basins and a review of contaminants in Baltic sediments is given by **Perttilä & Brüggmann** (1992).

Metal values from coastal sediments are rather scarce and are sampled over a long time period. Results for the open sea areas plus background and polluted coastal areas are given in Table 8. The background values from the coasts are often lower than those from the deep areas of the Baltic, which is a function of the positive correlation to the increased content of organic substance in the depths.

The concentration and retention of metals in the sediments are affected by the oxygen saturation and occurrence of hydrogen sulphide in the sediment surface, usually expressed as the **redox-potential**. Results given in Table 9 can be taken as an example, where concentrations of several metals are higher in the reduced than in the oxidized bottom areas in the Baltic Proper, especially of cadmium (resulting in a high figure for **quota:surface/deep** sediments) but also of lead and zinc (Borg et al., 1991).

Figure 30.

The concentration of cadmium, copper and nickel ($\mu\text{g/l}$) in the surface waters as a function of salinity (Kremling et al., 1987)

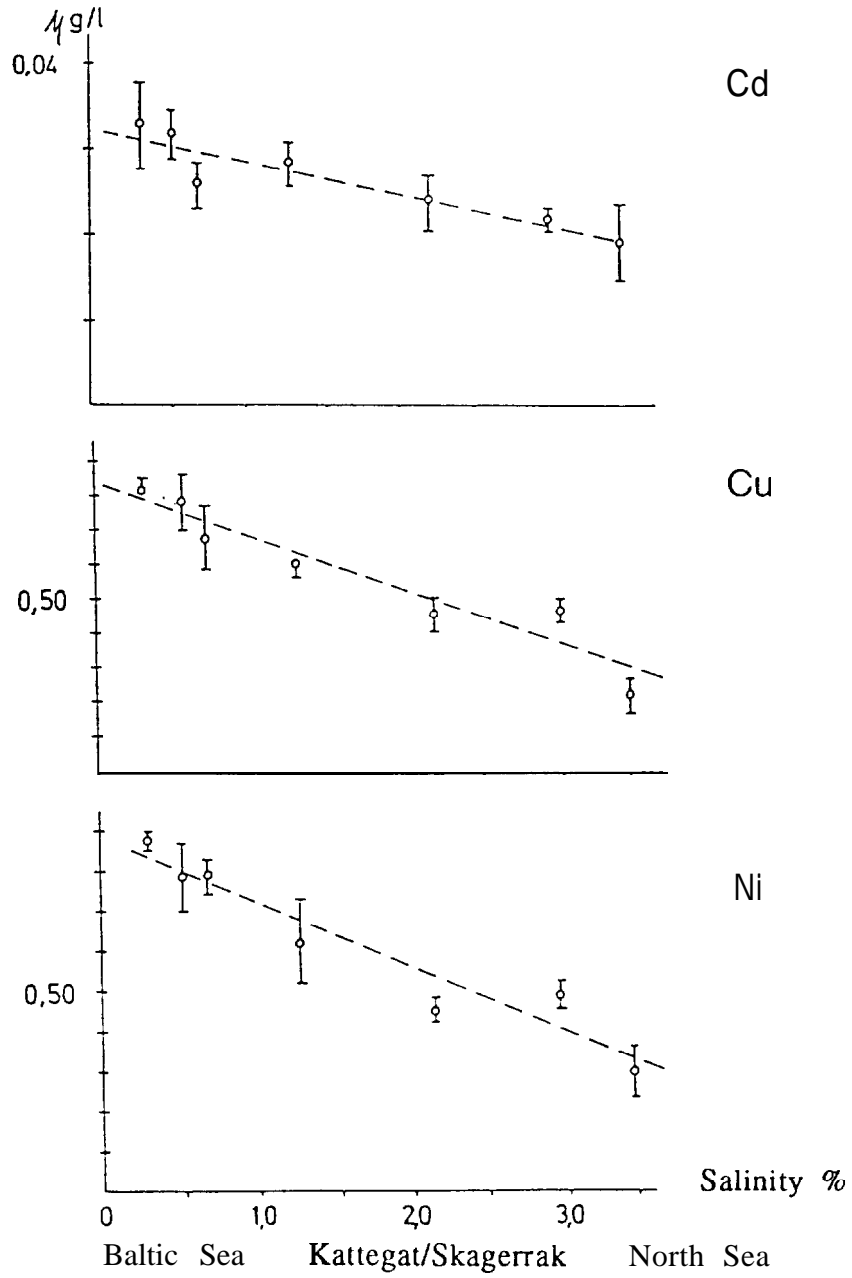

Table 8. Metal concentration in sediments from various areas of the Baltic Sea, mg/kg, dry weight.

Metal	Cr	c u	Zn	Cd	Pb	Hg
Open basins						
Bothnian Bay	37	41	142	0.80	60	0.40
Bothnian Sea	40	37	200	0.50	48	0.14
Åland Sea	38	39	230	0.60	50	0.18
Baltic Proper	38	65	350	2.60	72	0.10
The Sound	31	40	150	1.60	80	1.00
The Great Belt	27	27	109	0.70	43	0.20
Kattegat	25	15	92	0.17	20	0.13
Coastal sediments ("Background")						
FI		40	140	< 1.0	30	< 0.1
SE	20	20	150	1.0	30	0.3
DE	30	30	140	1.0	60	0.2
Coastal sediments* (Polluted local areas)						
FI	< 230	< 430	< 800	< 3	< 600	< 5
SE, Gulf of Bothnia ,				< 3		< 6
Baltic Proper	< 150	< 130	< 750	< 5	< 550	< 3
LT						< 4
DK	< 150	< 80	< 350	< 3	< 100	< 2
DE	< 120	< 50	< 600	< 4	< 110	< 2
PL	< 120	< 60	< 500	< 7	< 140	
DE/PL	< 500	C130	< 600		< 160	

* Maximum values reported from

FI: **Taalintehdas**, Kookkola

SE: Sundsvall, **Askrikefjärden** Stockholm, Oskarshamn, **Oxelösund**, **Mönsterås**

LT: Curonian Lagoon

DK: Roskildefjord, **Isefjord**

DE: German Boddens

PL: Gulf of **Gdansk**

DE/PL: Szczecin Lagoon/Oderhaff

Table 9. The quota between concentration of metals in the surface sediment (0-1 cm) and pre-industrial background in various areas of the **Baltic** Sea in 1990.

Sea areas	Zn	CU	Cd	Pb	As	Hg
Bothnian Bay	2.0	1.6	2.0	13.0	21.4	12.5
Bothnian Sea	1.5	1.1	3.0	1.8	2.6	6.5
Åland sea	1.5	1.1	2.5	2.0	1.3	6.3
Baltic Proper (oxidized sed.)	1.4	1.2	3.2	2.8	1.6	1.6
Baltic Proper (reduced sed.)	2.7	1.3	7.5	3.5	1.6	1.8

The opposite is known for **cobolt**, iron and manganese, which are more soluble under reduced conditions and thus leave the sediments of isolated and de-oxygenated deep areas. The concentration of copper is high and that of iron low in the reduced sediment in one of the basins of the Stockholm archipelago (Edgren 1978) with a high content of organic material (**Askrikefjärden** with the low dry weight percentage = TS % 0-10 in Figure 3 1) (Grimås & Suárez, 1988).

Figure 31. Concentration of copper and iron in sediment in a Stockholm archipelago basin (zone TS%=0-10) with high organic contents and de-oxygenated sediments during some seasons (after Edgren, 1978).

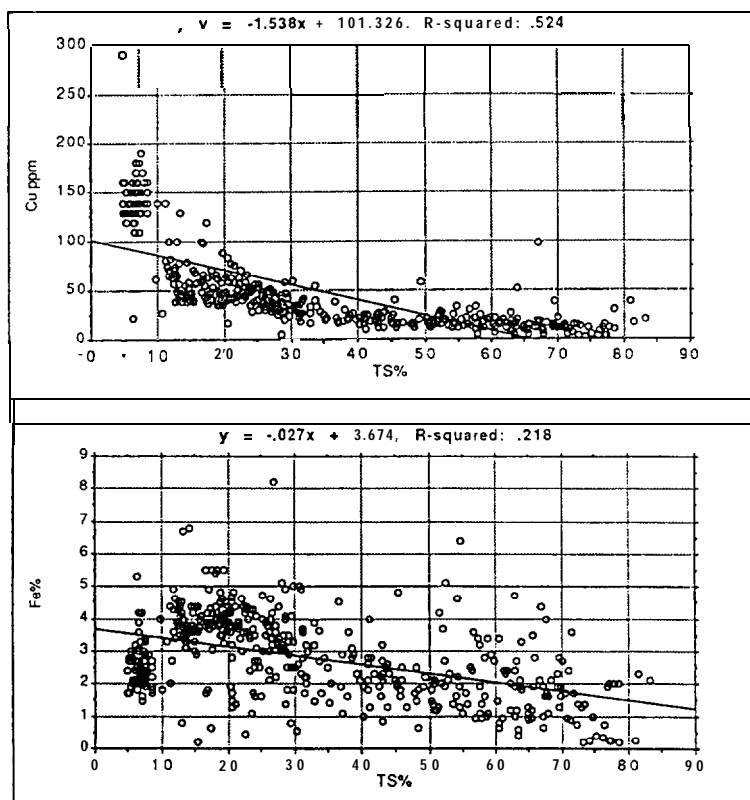

The reported maximum values from affected areas are, of course, dependent on the methodology used for sampling, e.g. the distance from a source, the preparation techniques of samples before analysis, etc. In general terms, the metal levels are, however, 5-10 times higher in the affected areas than in the background assumed.

The effects of the predominant water circulation along the coasts is demonstrated in the sediments off **Oxelösund** at the Swedish east coast (Figure 32). The metal levels are low in the transverse sections towards the coast from the north down to the source (sections 100 to 60) and a gradual and slow decrease southwards to section 10.

Figure 32. Contents of cadmium and lead ($\mu\text{g/g}$ dry weight) in sediment in a series towards the coast from the north (series 100) to the discharge area at **Oxelösund** (series 50) and to the south (towards series 10) (after **Grimås & Soárez, 1989**)

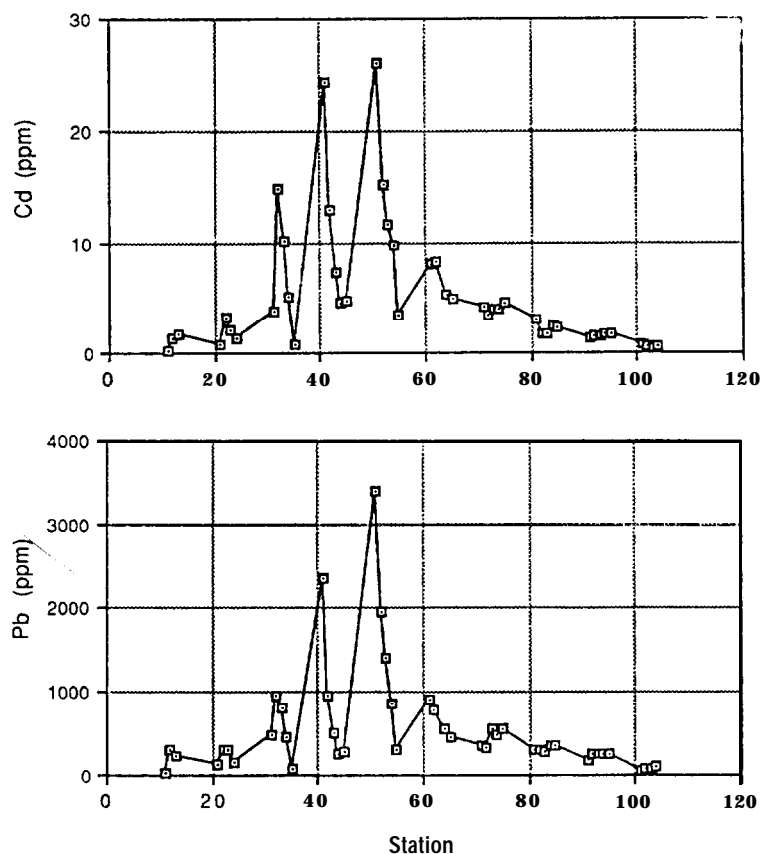

The levels of mercury are especially high in local areas of the Gulf of Bothnia or off pulp and paper industries in other areas. To a large extent this is a result of earlier emissions up to the 1970s. The surplus of mercury as well as arsenic and lead in the main sediment areas of the **Bothnian Bay** is presented in Table 9, where the indicated high contamination of lead is mainly an effect of very low pre-industrial concentrations compared with other water regions.

Interesting information is gained by parallel investigations in sediments and by sediment traps off some metal works and paper mills plus some reference areas along the Swedish east coast. Among the results can be mentioned a significantly lower concentration of lead in trapped material (60%) compared with surface sediment in the Bothnian Sea. This might reflect the decrease in atmospheric deposition taking place during the last decade, which plays a major role for the Bothnian Sea and Baltic Proper. A reduction in the load of arsenic and mercury is also indicated for the Bothnian Sea (Lithner et al., 1993). There is a specific value of such early information when evaluating results of measures taken and preparing a prognosis for the future.

4.1.3. **Biota**

The representativity has to be taken into consideration when using organisms as biological indicators of metals in the surrounding media of water or sediment and potential risks for the environment and man. Stationary and sedentary behaviour is a qualification for reflection of local, coastal conditions. Thus, molluscs and algae are often used internationally in monitoring programmes.

A stationary behaviour is difficult to attain when using fish as indicators of pollution, especially for reproduction and young stages of development. The best candidate among fish for many monitoring purposes, e.g. the transfer of mercury to man, is the *Zoarces viviparous* (viviparous blenny, eel pout, Aalmutter, **tånglake**, etc), which has an exceptional stationary behaviour, allows statistical analysis of the sensitivity of reproduction per female, as well as other qualifications for interpretation of local environmental effects. It has been used for metals at the Swedish west coast as well as internationally (cf. Grimås & Jacobsson 1991, Essink 1985, Elliott 1986) and for organogenic compounds at the Swedish Baltic coast. A description of this species as indicator of effects of toxic substances is given by, i.a. Jacobsson et al. (1993).

Various organisms are used for description of the fate of radioactive isotopes of metals, e.g. from the Chernobyl fallout. Algae are especially suitable as indicators (Snoeijs & Notter 1993). The conditions in the Baltic are reported by the MORS Working Group of HELCOM. The effects are available in reports presented by national authorities. A summary of research in Sweden on the topic is given in SSI (1991). It should be noted that edible products like fish from marine areas, including the Baltic Sea Convention area, never reached a level of radioactivity regarded as a problem for consumption according to national regulations.

The study of the behaviour of radioactive isotopes, e.g. Mn-54, Zn-65, Co-60, may be of interest for a general understanding of metal ecology in ecosystems and the mechanisms of accumulation of the stable metals (Grimås et al., 1986).

Biological indicators of metal pollution

Benthic fauna

The abundance, biomass and species composition of the zoobenthic communities are often regarded as good indicators of various types of disturbances by pollution. It should, however, be kept in mind that poisonous effects of metals might be just one of several potential negative effects close to a point source. The import of a mass of inorganic particles into the

sediment has a negative consequence for the availability of organic food particles. Such an effect on benthic communities is noted, amongst others, in impounded lakes where the transport of minerogenic material from the littoral zone into deeper bottom areas reduces the density of benthic animals because of dilution of organic material (**Grimås**, 1961).

For areas affected by mainly metals there exist only a few references. Clear effects of the discharges of several heavy metals (and sulphuric acid) from a titanium dioxide plant are reported by **Pitkänen et al. (1991)**, covering an area of about 300-400 km² off Pori at the coast of the Bothnian Sea. There are totally dead bottoms within 10 km² close to the outlet of the effluents, situated about 6 km from the coast-line. Disturbances to the benthic fauna of the sediments are also reported from an area of about 100 km² off the metal works of **Rönnskär** at the Swedish coast of the Bothnian Bay. In other areas, e.g. outside Kokkola in Finland, a decline of heavy metals (except mercury) has been noticed in the bottom fauna together with a recovery of the benthic communities during the 1980's (**Pitkänen et al.**, 1991).

Molluscs

A classical indicator of pollution is the blue mussel (*Mytilus edulis*), which occurs in most marine waters but is limited by the low salinity in the northern parts of the Baltic Sea.

A regional survey of metals in the soft tissues of the blue mussel was performed in the late 1970s at 34 stations along the coasts from Helsinki to Oslo plus 20 stations around Denmark (Phillips, 1977, 1978, 1979). A summary of the results is given in Table 10. The results do not reflect today's concentrations in detail but reveal the principles and differences between brackish and marine environments. The material also demonstrates the possibility to detect locally affected areas along the coasts.

There is an obvious decrease of metal contents in the mussels in the transition zone of the Sound between the Baltic Proper and the Kattegat (cf. Figure 33). The decrease of manganese and iron can be expected to depend on the long residence time of water and the sink of these elements in the Baltic Proper. The mean levels of zinc and cadmium are about 5 times higher in the Baltic Sea, which may partly be explained by higher concentrations in the Baltic waters compared to the Kattegat and partly by physiological effects on the mussels via the salinity.

There are also possibilities to detect local sources and problem areas. Increased levels of zinc and cadmium are found in a range of sites: in the Åland Sea as a result of emissions northwards, off Stockholm with a complex of metal emissions (also shown for chromium and nickel in mussels and bladder wrack), off the ironworks of Oxelösund, the increased accumulation in the cooling water plume from the nuclear power station at Simpevarp and, finally, in the Gothenburg archipelago in the northern Kattegat. It should be noted that the maximum level in this area just reaches the background levels in the eastern, brackish water areas.

Other investigations show an increase of cadmium in blue mussels and bladder wrack northwards from the Baltic Proper. The level of zinc seems to depend on the input from the river Dalälven into the southern Bothnian Sea from the mining district of central Sweden (Broman et al., 1987). The levels of cadmium indicate sources further north.

Table 10. Regional investigation of metals in the blue mussel, *Mytilus edulis*, in coastal areas by Phillips (1977, 1978). In soft tissue, mg/kg dw.

Metals	Mn	Fe	Zn	Cd
Main water areas				
Gulf of Finland	35	200	130	4.8
Åland Sea	10	170	175	7.6
N Baltic Proper, Sweden	50	370	155	4.8
S Baltic Proper, Sweden	20	170	170	4.4
The Sound, Sweden	18	80	120	1.9
-"- , Denmark	10	55	100	1.6
Great Belt	10	30	50	0.9
Kattegat	15	70	40	0.8
Some polluted areas in Sweden				
Oxelösund (ironworks)	65	1370	460	4.8
Simpvarp (cooling water)	14	160	290	12.9
Gothenburg	12	130	125	1.5

Metals reported in *Mytilus edulis* (soft parts) in mg/kg dw.

Metals	Cr	Mn	Fe	Co	Ni	Cu	Zn	Cd	Pb
Swedish coast	2	30	200	0.3	4	10	120	4	2
Gulf of Gdansk	3	33	400	0.4	4	35	160	5	11
Schlesw-Holst	2				2	12	150	3	3

A comparison between the southern Swedish coast and the Gulf of Gdansk in Poland does not reflect any major differences with the exception of lead, which is about 5 times higher in the mussels from the Polish Gulf. A comparison between various waters around Denmark shows levels of zink and cadmium about two times higher in the Sound than in the Belts.

Another bivalve mollusc used mainly as a substitute for the missing blue mussel in the northern Gulf of Bothnia is the Baltic mussel (*Macoma*). A comparison between the northernmost and southernmost part of the Convention area indicates about three times higher values of cadmium in the Gulf of Bothnia and three times higher values of lead in the Gulf of Gdansk. For the other metals there are about the same levels in the mussels from the two regions.

Gastropods (aquatic snails) have been used as indicators of the transport of metals from Rönnskär along the shores of the Gulf of Bothnia (Björklund, 1985). In the 1970s increased levels could be measured, at least 100 km southwards and 20 km northwards, of metals like arsenic, copper, zink, lead and mercury. During the 1980s the levels have decreased and are close to the estimated background values, except in the local area off the discharges.

Figure 33. Concentrations of zink and cadmium in soft parts of blue mussel along the coasts from Helsinki to Oslo (after Phillips, 1977).

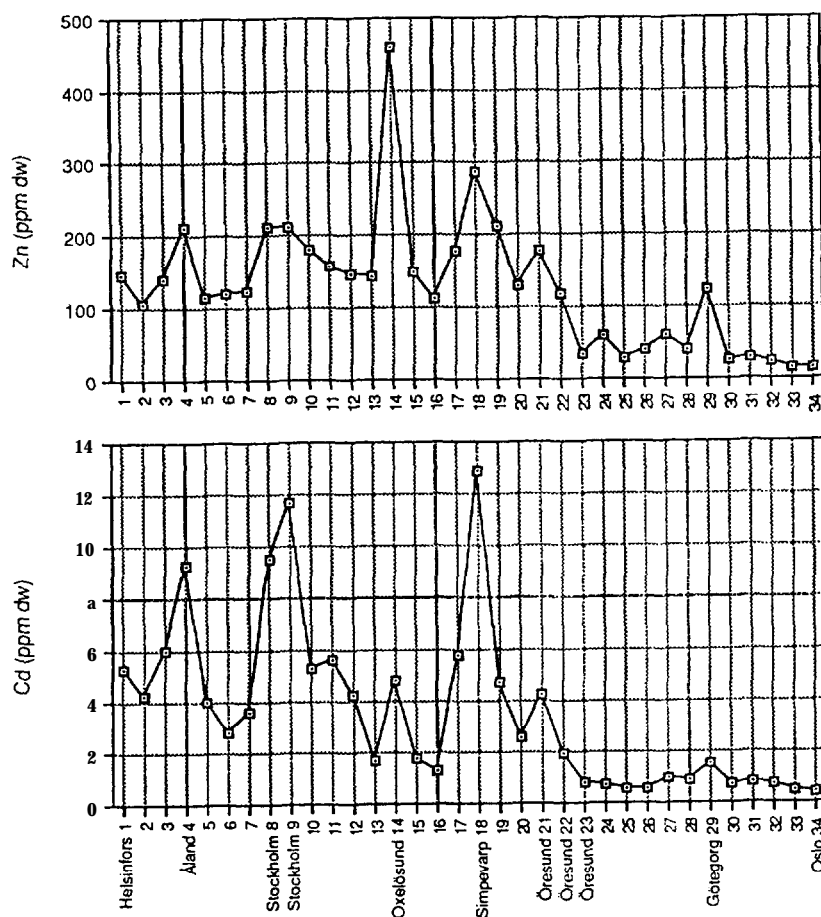

Crustaceans

The crustacean isopod *Mesidotea entomon* is included in the Baltic monitoring programme. It is a representative part of a macrobenthic community with wide distribution and a relatively long life period of about 8-9 years. The results available from investigations along the Estonian coast by Voloz et al. (1990) are compared with information available from the Gulfs of Bothnia, **Riga** and Gdansk (Table 11). The spectra of values (and number of analyses) are rather large in the Gulf of Bothnia represented by areas of various impacts. The most obvious divergences are the elevated levels of lead in the south-eastern Gulfs; about 10-20 times higher than those in the Gulf of Finland. A similar increase is presented for blue mussel in the Gulf of Gdansk; an area otherwise showing rather low metal values (Szefer, 1986). Elevated concentrations of cadmium are also noted in the Gulf of **Riga**.

Table 11. Metals in the crustacean *Mesidotea entomon* from various Gulfs of the Baltic. In mg/kg dry weight.

Area	Year	Cu	Zn	cd	Pb
G. Bothnia					
Both. Bay *	1977	79-26 1	68-120	1.42 - 4.54	0.68 - 7.89
Both. Sea **	1980	65-206	108-154	1.30 - 1.80	0.70 - 2.50
Both. Sea ##	1981-82	127-178	58- 93	0.20 - 0.53	0.31 - 0.90
G. Finland					
FI ***	1977	121-126	73-131	0.88 - 0.91	1.05 - 1.86
EE ****	1988	86-160	86-200	0.61 - 1.63	1.14 - 2.49
G. Riga LV +	1984	110-170	68-167	1.32 - 5.44	14 - 48
G. Gdansk ++	1986	9- 26	26- 95	0.22 - 0.60	23 - 45

*	Oulu-Kokkola	Voipio et al. 1977
**	Pori	Häkkinä 1980
##	Pori seawards	Sandler 1986
***		Voipio et al. 1977
****		Voloz et al. 1990
+		Seizuma et al. 1984
++		Szefer 1986

Data on arsenic in zooplankton indicate an effect in the open waters of the Gulf of Bothnia. A successive decrease has been noted and the concentration in 1987 is about 65% of the levels in 1975 or about 10 $\mu\text{g/g}$, dry substance (Lithner et al., 1991). The deposition of arsenic in the sediment is today probably a more important source than the direct discharge.

Algae

Other sedentary organisms used for descriptions of gradients are the algae. Material along the coast from the northern Baltic Proper into the Bothnian Sea (Söderlund et al., 1988) shows peaks of chromium and nickel in bladder wrack (*Fucus vesiculosus*) when passing the outer Stockholm archipelago; a further increase of zinc up to the mouth of the river Dalälven and a continuous increase of cadmium northwards in the Bothnian Sea.

Metal accumulation in algae from the eastern coasts is demonstrated by Jankovski et al. (1988) indicating higher levels of, e.g. lead in the southeastern part of the Gulf of Finland. Macroalgae as indicators of metals in Finnish waters are also discussed by Kangas & Autio (1986) indicating *Fucus* to give the most reliable results.

The brown algae *Fucus* has also been used for comparison of metal levels in material from 1933 and 1984 at the Swedish east coast (Forsberg et al., 1988). The results demonstrate pronounced differences in metal content with higher concentrations of, e.g. lead in 1933 and nickel and cobalt in 1984.

Fish

Metals in fish species have been analyzed because of their economic importance, especially the large stocks of herring, sprat and cod. These are mainly representative for the open sea areas. It can also be noted that available results are often reported for muscle tissue, which does not reflect the concentration in the media of water or fish food. One of the exceptions from this rule, and regarded important for man's consumption of fish and shellfish, is mercury, which is accumulated in fish muscle.

Many stationary fish species are economically important in the large coastal waters like the Gulf of Gdansk, the Riga Bight, the Curonian Lagoon or the archipelagoes of Finland and Sweden. Unfortunately, metal analyses are rare, e.g. of organs like fish liver, which are regarded as relevant for estimation of environmental quality. Even here there are some complications in the interpretation of results. The metal content should be correlated to the fat content of the liver, which is shown, e.g. for cod liver (Grimås et al., 1985) but which is probably valid also for other fish species.

The content of metals in liver can also be related to season, which is demonstrated for pike at 28 coastal areas along the Swedish east coast from Bothnian Bay to southern Baltic (Grimås & Suárez, 1989). The variation is shown in Figure 34 with low values in winter and a decrease in late summer in all areas during the main period for growth of pike.

Figure 34. Seasonal variation in concentration of zink ($\mu\text{g/g}$ wet weight) in pike liver from the Gulf of Bothnia and the Baltic Proper.

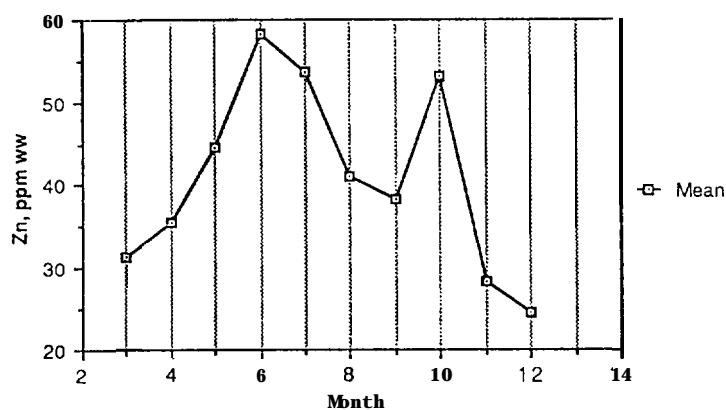

A clear seasonal variation of, e.g. copper and magnesium content, is also reported in liver of a whitefish species, *Coregonus nasus*, in the northeastern part of the Bothnian Bay (Hyvärinen & Valtonen, 1973). These variations in metal content in organs used for indication of relationships between organisms and the environment have to be clarified before being introduced into monitoring routines.

Seals

The concentrations of metals (Al, Ca, Cd, Co, Cr, Cu, Fe, Mg, Mn, Ni, Pb, V, W, Zn) were determined in liver and kidney cortex from three Baltic seal species. The concentrations of Hg and Se were determined in liver and As in blubber tissue (Frank et al., 1992). The material comprises harbour seal (*Phoca vitulina*), grey seal (*Halichoem grypus*) and ringed seal (*Phoca hispida*) from the Baltic Sea plus harbour seal collected along the Swedish west coast. Only the concentration of Cr seemed slightly higher in the Baltic. The concentrations of studied material, including Hg, Cd and Pb, were at the same magnitude or often lower than those reported in other studies, including the same species in the arctic region. The results do not indicate that Baltic seals are suffering from a high metal contamination.

Some facts about mercury

Levels of mercury in coastal fish are available only from some areas around the Baltic Sea and seem to be a problem for the coastal areas and not for the open sea areas. Some coastal waters have been blacklisted for commerce of fish. Some inner archipelagoes in Sweden, Finland, Estonia and areas close to Copenhagen are important for stationary species. There is, e.g. a ban of fishing cod and flounder in certain defined Danish areas of the Sound in vicinity of Copenhagen. The principle of blacklisting in Sweden has been taken under consideration by the authorities and has been changed into recommendations.

Mercury in biota is presented in Table 12. In general the concentration of mercury increases for each step taken to the next **trophic** level, from the vegetation to the carnivorous fishes. One exception has already been mentioned; the specific properties of the fine branched diatoms with adsorption of metals at the cell surfaces (cf. Snoeijns et al., 1992).

A semi-coastal species like the flounder, which migrates between shallow and deep areas during the year, does not seem to reach the high levels. Other, and more pronounced concentrations, are noted for perch and pike in various areas, especially in the isolated archipelagoes and in the vicinity of industrial or large population centres.

The Hg-concentration in fish is somewhat higher in the Gulf of Bothnia than in the Baltic Proper. The difference is indicated by perch from coastal areas chosen as comparison areas not affected by local sources. At Holmön, in the transition area between Bothnian Bay and Bothnian Sea, the mean value is 54 $\mu\text{g}/\text{kg}$ and at Kvädö, Baltic Proper 41 $\mu\text{g}/\text{kg}$ wet weight, which are the lowest observed in coastal fish together with pike from Åland (cf. Table 12).

High levels of mercury are noted in some Swedish and Finnish coastal areas of the Gulf of Bothnia, especially at old pulp and paper industrial sites where mercury is still leaching out from the sediment depositions. High levels in biota are also noted in the Gulf of Finland, in some parts of the Estonian archipelago and in the Sound.

Table 12. Mercury in organisms in the Baltic Sea area in wet weight (ww) and dry weight (dw).

Organism	year	$\mu\text{g}/\text{kg}$ - -	$\mu\text{g}/\text{kg}$ dw.	country	sub-area	
<i>Diatomae</i>	1991		100-1020	SE	Rönnskär , Bothn B.	
	1991		100- 227	SE	Forsmark , Bothn S.	
<i>Cladophora</i>	1990		<50- 200	SE	Sundsvall, Bothn S.	
	1980		30- 90	SE	Stockholm arch.	
	1977-82	- 7		LV	Gulf of Riga	
<i>Enteromorpha</i>	1977-82	2 - 24		LV	Gulf of Riga	
<i>Fucus</i>	1980		3 - 40	SE	Oskarshamn	
	1977-82	- 18		LV	Gulf of Riga	
<i>Mytilus</i>	1981	8 - 40	50 - 230	SE	Oxelösund	
	1986		60 - 300	SE	Oskarshamn	
	1982-86		50 - 180	SE	Kalmar	
	1992		130 - 550	SE	Pukaviken	
	1977	40 - 80		EE	Muuga-Ihasalu	
	1975-76	20 - 30		EE	Gulf of Tallinn	
	1977-82	27 - 47		LV	Gulf of Riga	
	1979		36 - 70	PL	South. Baltic	
	1981		70 - 230	DE	Pomeranian Bight	
	1985	1 - 50		ICES	The Sound	
	1986		20 - 70	DK	Lille Bælt	
	1982-85	7 - 23	38 - 110	SE	Kattegat	
	<i>Mesidothea</i>	1985-86	10 - 57		FIN	Gulf Bothn., central
		1980	10 - 100	310 - 750	FIN	Kokkola
1975-82		20 - 90	160 - 660	FIN	Pori	
1965		30	180	EE	Gulf of Finland	
1985-87		15 - 18		FIN	Gulf of Fin., mouth	
1977-82		15 - 124		LV	Gulf of Riga	
<i>Macoma</i>	1975	30 - 80		FIN	Pori	
	1985	30 - 150		FIN	Kokemäenjoki	
	1975	40 - 70		FIN	Pyhämaa	
	1975-76	50 - 110		EE	Gulf of Tallinn	
	1977-82	21 - 38		LV	Gulf of Riga	
	1979	40 - 200		PL	Gulf of Gdansk	
	1992	26 - 102	130 - 550	SE	Pukaviken	

Table 12 cont. Mercury in organisms, fish species.

Organism	Year	$\mu\text{g/kg ww}$	$\mu\text{g/kg dw}$	country	subarea
<i>Platichthys</i> (flounder)	1978	50 - 90		EE	Paldiski Bay
	1981-89	110 - 260		EE	Islands
	1978-87	39 - 340		SE	The Sound
	1983-84	30 - 920		DK	The Sound
	1989	60 - 510		DK	The Sound
	1984-87	40 - 360		DK	Nivå Bight
	1984-87	1 - 154		DK	Great Belt
	1982	40 - 120	190 - 600	DK	Fornes
	1980-83	31		SE	Kattegat
<i>Rutilus</i> (roach)	1976-82	6 - 260		SE	Oxelösund
	1981-89	80 - 430		EE	Moonsund
	1985-89	30 - 360		DE	Meckl-Vorpom
<i>Anguilla</i> (eel)	1973	200 - 500		SE	Sundsvall, Bothn S.
	1986	190 - 480		SE	Kalmar , S Sweden
	1980-81	50 - 950		SE	The Sound
	1987	118		SE	The Sound
	1981	200 - 700		SE	Gothenburg arch.
<i>Perca</i> (perch)	1991	31 - 145		SE	Holmön, Bothn.Bay
	1991	100 - 630		SE	Sundsvall, Bothn. S.
	1988	470 - 1750		SE	Gävle , Bothn. S.
	1980-90	200 - 1990		SE	Stockholm arch.
	1976-82	20 - 180		SE	Main coast, Baltic
	1991	24 - 63		SE	Kvädö , Baltic
	1978	150		EE	Paldiski Bay
	1981-89	70 - 980		EE	Haapsalu Reg.
	1985-89	20 - 600		DE	Meckl-Vorpom
<i>Esox</i> (pike)	1991	120 - 640		SE	Sundsvall, Bothn S.
	1988-90	170 - 1900		SE	Gävle , Bothn S.
	1989	50 - 310		FIN	Gulf of Bothn
	1978	190 - 1470		FIN	Gulf of Finland
	1989	100 - 900		FIN	Gulf of Finland
	1989	50 - 60		FIN	Åland Sea
	1968-69	250 - 1450		SE	Stockholm arch.
	1973-79	230 - 2800		SE	Stockholm arch.
	1978	60 - 140		EE	Paldiski Bay
	1981-89	60 - 1500		EE	Haapsalu Reg.
	1985-89	65 - 450		DE	Meckl-Vorpom
	1982-87	120 - 420		SE	Blekinge, S Sweden

Figure 35 demonstrates the relationship between weight and mercury content in perch from various parts of the Stockholm archipelago. No major decrease in mercury concentration seems to have occurred during the last decade.

Figure 35. Perch in the Stockholm archipelago. Relation between fish weight and mercury content in muscle.

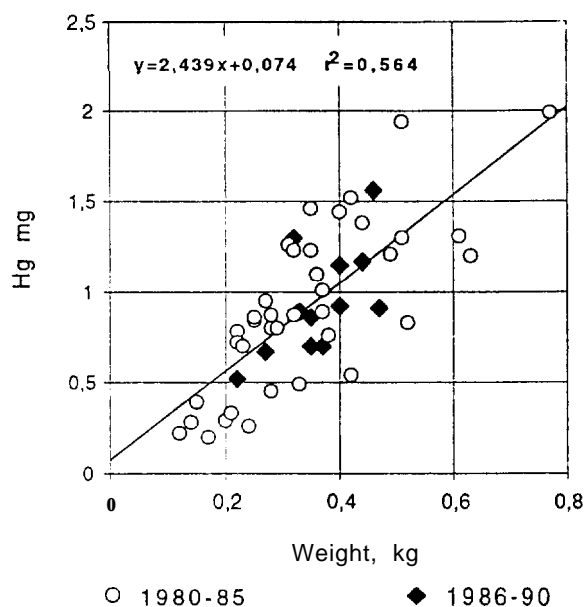

Comments on toxicity

The concentration of metals measured may be a result of adsorption to the surface of the organisms, examples being found in many algae. This leads to especially high values in organisms with a large surface area compared to the biomass, e.g. the fine branched diatoms (see Table 12). The effects on the surface are not necessarily toxic but may affect the conditions, e.g. by physical isolation.

Taking the step from vegetation to vegetarians, the metal is often accepted in metabolism and thus also absorbed by the organisms. There is also a direct uptake from water, e.g. through organs like gills. If an animal has no protective mechanisms against uptake, storage of certain metals is possible in certain organs, or a circulation with potential toxic effects. The above-discussed **physico/chemical** form of the metal has a decisive effect on the physiological processes involved.

The critical toxicity levels for adult fish are often higher than those for other organisms. The most sensitive stages in the life-cycle are, for most species, reproduction and early stages of development. Here our knowledge is limited.

When looking at the concentrations in water or sediments from various areas, it seems obvious that levels of metals are reported where risks to organisms can be identified, without taking into account aggravating circumstances like synergistic effects or the extra sensitivity of reproductive stages.

Some studies on effects

To judge from results of experiments, primary producers, e.g. some species of algae, react approximately at the same or even lower levels than other organisms. It seems that they are very sensitive to copper, in the same way as the mussels. The toxicity is caused mainly by the free ions (about 1/100 of the total concentration) which are active at 0.006-0.06 $\mu\text{g/l}$ and regulating the communities already at the natural concentrations in water. Another effective metal is arsenic (as arsenate). The growth of bladder wrack (*Fucus*) is repressed already at 6 $\mu\text{g/l}$ in the salinity of the southern Baltic and depression of primary production is especially effective in waters with a deficit of phosphorus, e.g. in the Bothnian Bay.

Table 13 gives some data on toxicity for the blue mussel, gained mainly in the laboratory but also from field experiments (Hesse et al., 1990, Janus et al., 1989, Strömngren, 1982).

Table 13. Levels of some metals in sea water, where effects have been observed on the blue mussel, *Mytilus edulis*.

	Ref.	Exposure, days	Concentration, $\mu\text{g/l}$	Effects/comments
Nickel	*	2 - 22	> 200	growth inhibition
Zink	*	22	10	growth inhibition
	*	2 - 6	60	EC-50, growth inhib.
Copper	*	2 - 22	3	growth inhibition
	*	2 - 6	3-4	EC-50, growth
	**		6	EC-50, acute:
Lead	*	2 - 22	> 200	growth
Mercury	*	2 - 22	0.3	growth inhibition
	*	2 - 6	16 - 48	EC-50, growth
Cadmium	*	2 - 22	10	growth inhibition
	*	2 - 6	100	EC-50, growth
Arsenic	***	2	3000	LC-50, acute/AsIII

* = Strömngren 1982

** = Janus 1989

*** = Hesse 1990

These values give some sort of an overall magnitude of risks in the environment. A typical complication is, however, synergetic effects with other elements, which often lower the tolerance limit for a single, potentially toxic substance.

Studies on effects of metals on blue mussel (*Mytilus*) are reported, e.g. from Finland. Mussels exposed to elevated concentrations of copper and cadmium for 24 hours were placed in cages in the sea and analyzed after one year. Effects were noticed on survival, growth and shell morphology (Sunila & Lindstriim, 1985). As an example can be mentioned deformities found on 63% of mussels exposed to Cd, 46% to Cu, 26% in control cages and only 3% in the natural population. Other investigations on natural populations of *Mytilus are* reported by Lindstriim (1986) where the deformities decreased gradually from about 45% in the vicinity of an iron and steel works at Koverhar in southwestern Finland to about 3% at a point 4 km from the plant to the southeast in the archipelago.

Physiological methods previously used as health indicators in laboratory investigations on fish exposed to pollutants have been applied to fish living in metal-polluted coastal waters. The results are summarized by Larsson et al. (1985) (internationally) and in a final project Report in Swedish in 1986, including references to sub-reports.

The results show that clinical physiological methods may be very sensitive instruments for detecting and diagnosing sublethal disturbances in fish living in waters affected by metal pollution. Many of the results originate from investigations off large metal works like Rönnskär in the Bothnian Bay.

Aberrant values for several physiological parameters indicate that metal pollution has a profound influence on important functions such as immune defence, ion regulation and glucose homeostatis, and point to obvious and serious physiological imbalance. Tested parameters, e.g. the erythrocytic ALA-D activity, the lymphocyte number and the chloride concentrations in blood plasma are in good agreement between effects noted in fish exposed to metals under natural field conditions and those found in laboratory tests.

Among other studies on fish and pollutants can be mentioned spinal deformities on fish, e.g. off the Finnish coast of the Bothnian Bay (Bengtsson & Miettinen, 1986). The results show defect frequencies on fourhorn sculpin (*Myoxocephalus quadricornis*) ranging from 8.1 to 24.6%; the two highest frequencies originating from areas exposed to an increased load of heavy metals (Kokkola and Vaasa). A correlation seems to exist to the content of mercury in muscle and liver.

4.2. Organic compounds

The occurrence of organic harmful substances like petroleum or chlorinated hydrocarbons is discussed in the two Periodic Assessments of the open Baltic from 1987 and 1990. The presentations also include some peripheral coastal areas of interest for this report. It is stated that any intercomparison of concentrations of organic pollutants at various trophic levels and ecological compartments in space and time is complicated by the obvious analytical difficulties.

Provident research planning based on, for example, lessons learned from the research on mercury, laid the accent on top predators like fish-eating sea birds and seals and their prey in the marine environment. This in turn covers the main commercial fish stocks in the Baltic like herring, sprat and cod.

For many potentially toxic substances like some metals, radionuclides, etc., negative effects can be demonstrated mainly by laboratory experiments. Certain elevated concentrations leading to physiological, reproductional or other injuries, permit a mutual comparison between tested toxins. For organic pollutants it has been possible to relate deleterious effects to the load in the environment on various organizational levels from individuals to populations, locally or regionally. This is important to accentuate. For the group of organic contaminants, the necessity to follow up these demonstrations is realized. Actions taken against artificial “new contaminants”, introduced by a successive leakage from industrial activities, are particularly vital.

4.2.1. **Petroleum hydrocarbons**

It is a general difficulty in assessing data given in the national reports. This is a result of two different techniques being used. In some countries the fluorescence (UVF) technique was applied as recommended in the guidelines for the BMP areas, whereas in other instances the infrared photometric technique (IR) has been used.

A relative comparison has been used for each of the two types of data. The background concentration level reported for deep water of open sea stations when using each analytical technique as reference.

Data are given for the eastern part of the Gulf of Finland including the bays of Neva, Vyborg, **Luga** and Koporje, the Gulf of **Riga**, the ports of Ventspils and Liepaja at the Lithuanian coast, the Curonian, Vislinsk and Vislana Lagoons, off Baltijsk and Pionersk at the Kaliningrad coast, the German Bodden waters and the Wax-now and Breitling estuaries (**Brüggmann & Bachor**, 1990, HELCOM, 1991, Litvinenko et al., 1990). Earlier data on petroleum hydrocarbons in water, sediments and organisms from coastal areas are also available in the previous two assessments presented in HELCOM (1987, 1990).

The general picture is that levels are near background values or slightly elevated, except close to river mouths, ports and shipyards, where high values have been observed.

Water-carried particulate matter (seston) collected in sediment traps has been used for fingerprinting petrogenic hydrocarbons (PHC) along an urban influenced transect in the Stockholm archipelago (**Broman et al.**, 1987a). A gradient of increasing PHC **downflux** towards the urban area was found and petrogenic contamination of the waters was detected along the whole transect. Analyses of lead concentrations in seston samples from the same archipelago (**Broman et al.**, 1988) show a strong linear correlation with the total PAH concentration (Figure 36). The results indicate that automobiles are highly responsible for the situation since there are no other significant sources of lead than from traffic.

Finland reports decreasing oil concentrations in water, biota and sediments off their refineries since the 1970s and low values nowadays. As an example can be mentioned the load of oil by the refinery and petrochemical industry of Porvoo in the Gulf of Finland, where the emissions have decreased by about 20% during the 1980s, without, however, a notable decrease of concentrations in bottom areas (**Pitkänen et al.**, 1991), but unable to trace because of, e.g., analytical bias.

Figure 36. Concentrations of lead correlated to the total PAH concentrations of seston samples for two periods; winter-spring (January-May) and summer (July-September) in the Stockholm archipelago (Broman et al., 1988).

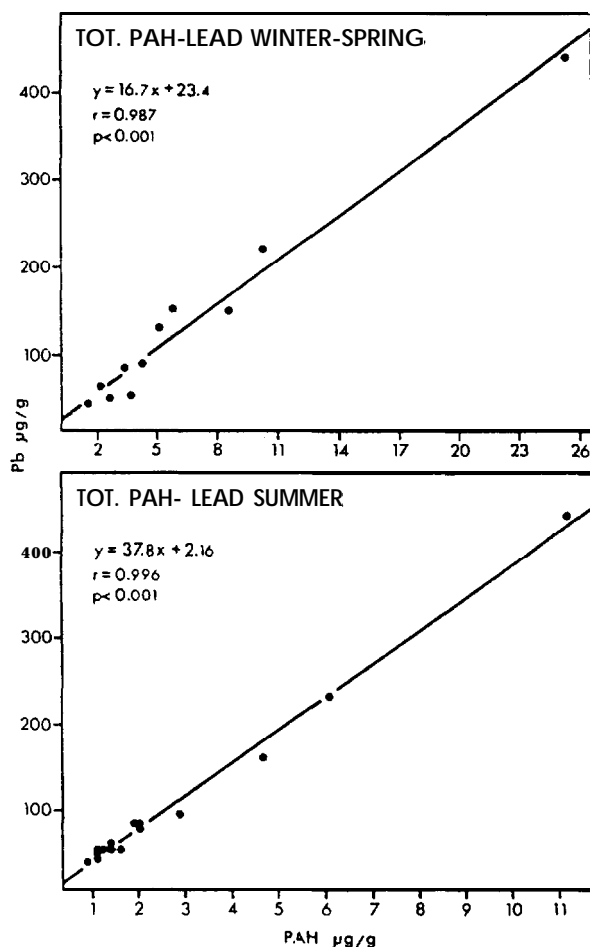

Hydrocarbons in seaweeds at 23 stations along the Estonian coast in 1988-89 are reported by Talvari et al. (1992). The results gained by UVF technique indicate rather similar mean concentrations, e.g. in various algal species: 6.4 (0.6-16) **mg/kg** dry weight in green algae, 8.1 (3.3-24.1) in brown algae and 5.4 (0.2-19.1) in red algae. A variation in concentrations is, on the other hand, noted between sampling locations, being higher in urban and harbour areas.

The presence of unsubstituted polynuclear aromatic hydrocarbons (1-6 **µg/kg** wet weight) in the blue mussel, (*Mytilus edulis*) from the Pomeranian Bay in Poland indicates contamination with petroleum hydrocarbons (Andrulewicz, 1992).

The fact that measurements in the environment indicate rather low levels of petroleum hydrocarbons in the main parts of the coastal areas does not exclude the risks for negative effects. Chronic pollution, which refers to diffuse input, is regarded as dominant, making up approximately 90% of the total input. Despite the fact that there are shortcomings in our

knowledge of effects of various petroleum fractions, there is sufficient data to justify intensified efforts to reduce discharges of petroleum hydrocarbons into the marine environment.

Episodic pollutions, which refer to major, temporary discharges in cases of, e.g. shipping accidents, are more obvious. These are often visible and easy to detect and follow up. Despite the uncertainties in the input estimates, the oil pollution should be considered as a problem in the Baltic Sea. The probability of oil pollution is high because of intensive shipping, increasing offshore oil production and heavy **industrialization** of the Baltic Sea States. Yearly oil spills are mapped and published by the Combatting Committee of the Helsinki Commission based on national reports. Oil pollution problems in the Baltic marine environment have been discussed by Hirvi (1989), amongst others.

Accidents

Sea traffic through the Baltic Sea is heavy, both with respect to the frequency of ships and tonnage. The largest tankers, that are permitted to enter the Baltic Sea via the shallow and narrow entrance have sizes up to 160 000 tons (DW). None of these large tankers have yet been involved in an accident but the risk of grounding and/or collision is obvious.

There have been two large oil spills of over 5 000 tons in the Baltic Sea. The largest spillage was caused by the British tanker “Globe Assimi” off the Lithuanian coast at Klaipeda in December 1981. The tanker was totally wrecked and about 16 500 tons of heavy fuel oil and 230 tons of bunker oil was spilled into the sea. It could be estimated that about 4 000 tons of oil was left in the marine environment. There was a sharp decrease of the *Furcellaria* vegetation along the shores from Klaipeda and northwards along the Latvian coast up to Ventspils of which an area from Pape to Liepaja is demonstrated in Figure 26, Chapter 3.2, where *Furcellaria* vegetation is still left. The relationship between the stock of *Furcellaria* and concentration of petroleum hydrocarbons in sea water is shown in Figure 37, covering a wider coastal area from Klaipeda to Ventspils (Korolev et al., 1993B). It is proposed that the deposition of oil has been leaking out from the sediments during some years after the accident with negative effects on the benthic vegetation.

The second largest oil spill took place in 1979 off the Latvian coast. The Soviet tanker “Antonio Gramsci” ran aground losing about 6 000 tons of crude oil. The oil drifted hundreds of kilometres northwards and caused damage to birds in Swedish and Finnish archipelagos.

Each oil spill incident presents a different pattern. Biological damage is not always relative to the amount and type of oil spilled. In 1976 an oil spill of about 10 tons caused severe damage to **seabirds** off the island of Öland in the Swedish coastal area. At least 33 000 birds were killed. In February 1987 the grounding of the Soviet tanker “Antonio Gramsci” off the southern coast of Finland caused a spillage of about 570 tons of crude oil. The oil drifted with ice-fields in the Gulf of Finland and threatened sea birds during several months but only 40 birds were killed by the oil which, however, affected fish and fisheries.

The oil spills occurring in an ice-covered sea area are the most problematic. There are no effective measures or oil recovering equipment for combatting of oil under ice conditions. Oil will decompose very slowly, drift long distances with ice, be split into small spills and cause severe pollution along coasts.

Figure 37. The development of *Furcellaria lumbricalis* and concentration of petroleum hydrocarbons in sea water in the Klaipeda-Ventspils region, 1978-1989 (Korolev et al. 1993B). (Solid line (K)= hydrocarbons in mg/l, broken line (M) = *Furcellaria* in thousand tons).

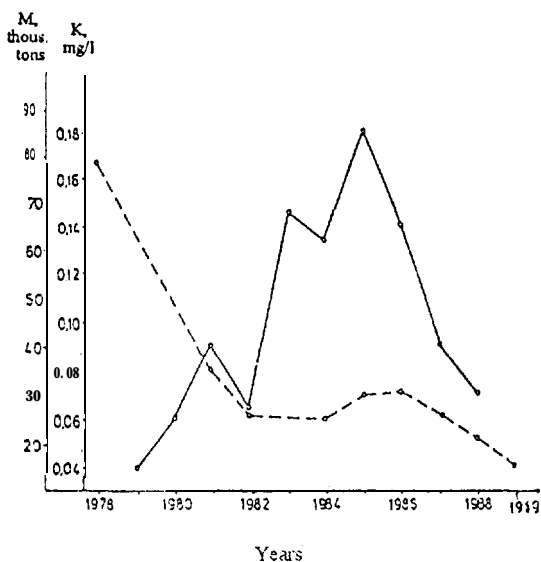

Based on the environmental studies of accidental oil spills, the oil has been predicted to have considerable local effects, mainly on birds and coastal benthic communities (cf. Kineman et al. 1980, Pfister 1980, Vainio et al. 1987).

Long-term effects can be exemplified by studies of the effects of spills of about 1 000 tons of medium grade fuel oil from “Thesis” off the Swedish coast in the northern Baltic Sea in October 1977 (Elmgren et al., 1983). The investigations show that the initial impact of the oil spill was well marked on the macrobenthic community. The total abundance decreased drastically, e.g. by elimination of crustaceans like *Pontoporeia*. Small changes were noted in the total biomass, which is dominated by the clam *Macoma baltica*. This mussel endured in spite of the fact that an initial contamination of total hydrocarbons of about 2 000 mg/kg (dry weight) was noted, a concentration that decreased to about 1 000 in the second summer and 250 mg/kg dw after three years which is about twice those at the coastal reference station (GC and GC/MS analyses). In fact, a successful recruitment of the clams was noted after some years, which might be explained by the absence of predation by crustaceans upon young, settling mussels. This seems, in turn, to result in a long-term effect on the balance between species in the benthic communities. Effects in the sediment bottoms can be observed a decade after the accident. In comparison, the observations show that effects in the littoral zone are difficult to confirm after some years and in the free water mass after some weeks (Elmgren, 1985).

4.2.2. DDTs and PCBs

The use of several chlorinated hydrocarbons, e.g. **DDTs**, **PCBs** and **HCHs**, has been discontinued by the Baltic states. The former can still be detected in the entire Baltic. A general decline of these substances is, however, obvious at the various **trophic** levels of the marine system.

The occurrence and behaviour of these banned substances are exemplified in this report mainly by **DDTs** and **PCBs**, which are **characterized** by high persistence and bioaccumulation and still constitute a potential threat to the biota.

In this context it should be recorded that decisions taken at the international level of the Convention constitute a pre-requisite, on which it has been possible to anchor national long-term series of routine observations based on biota from the open part of the Baltic Sea. Studies from the coastal zone have been assigned for national responsibilities. There is today an obvious lack of information from the coastal areas.

4.2.2.1. Trends over time

Observations on **DDTs** and **PCBs** in the aquatic environment exist since the 1960s; for **PCB** being discussed in the environmental report by Jensen (1966).

There is a well-established and general downward temporal trend in the occurrence of these contaminants extending from the first data reported in the late 1960s until the present (cf. Olsson & Reutergårdh, 1986). The reduction is slower for **PCBs** than for **DDT** and the different rates mean that the ratio between **DDTs** and **PCBs** is decreasing over time. In general, the reduction of **DDTs** is about 90% and the metabolite **DDE** today dominates the sum figure. The reduction of **PCBs** is estimated to be more than 50% in **fish** and **birds**.

The scattered availability of information from the coastal zone and the weakness in quality when comparing old and new data as a result of a changed analytical procedure, in the main, limits the discussion to descriptions of scenarios. This means comparisons between species or differences between water areas within a certain time period. It should be pointed out that even this exercise is problematic because of the analytical problems concerning fat content in organisms. Of principal interest are also descriptions of routes of the elements in the biological systems in coasts versus open sea, or effects of local discharges of organochlorine compounds.

The long-term decrease of **DDTs** and **PCBs** is most thoroughly described for species like herring and their predators and with a technique comparative for all steps of analyses over time. The organisms are mainly representative for the **open** waters. Examples are given in Figure 38 (Bignert et al., 1992), which describes the geometric mean concentrations adjusted for fat content in spring-caught herring from the Karlskrona area in the southern Baltic Proper and a non-parametric smooth curve fitted to this time series.

Another information on time trends given by Bignert et al, (1993) in Figure 39, illustrates the parallel elimination process of total **PCB** in the prey of herring and the eggs of the predator, the guillemots (*Uria* algae) from the central Baltic.

Figure 38. The decline of organochlorines in herring from the Karlskrona area, southern Baltic Proper, 1972-1989 (Bignert et al., 1992).

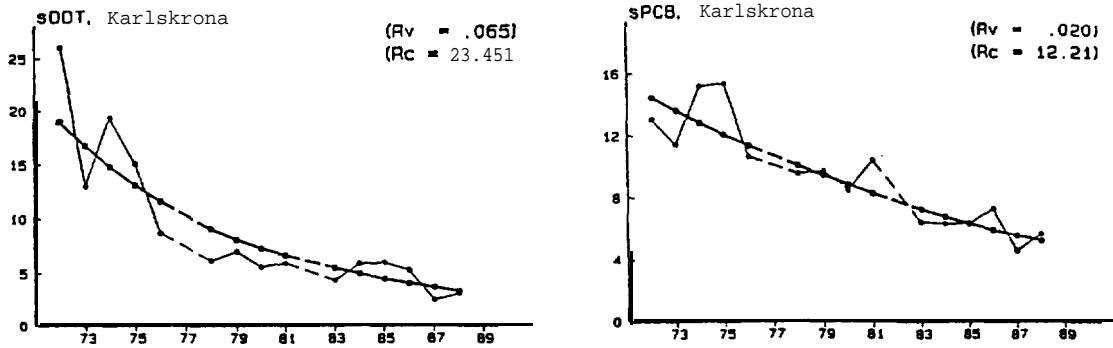
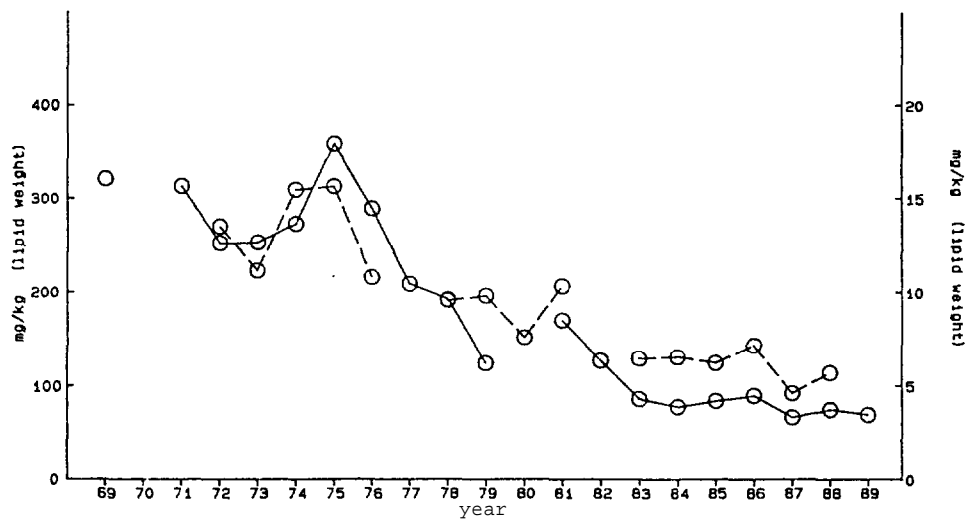

Figure 39. Concentration of total PCB (mg/kg lipid weight in herring (- - -) and guillemot eggs (_____) from the southern part of the Baltic (Bignert et al., 1993).



For species more representative for coastal areas, trends over time exist from shorter **periods**. Perch has been studied in two reference areas, one in the central part of the Gulf of Bothnia and one from the central part of the Baltic Proper. Comparing these two series with similar studies on herring during the same period and in the same marine regions, shows convincing conformity with respect to trends for **DDTs** and **PCBs** (Bignert et al., 1992). A significant downward trend is found in perch from the Gulf of Bothnia. Also studies on blue mussel in the Kattegat show a similar trend of decrease of concentrations over time. The results indicate a conformity with respect to trends in coastal and open waters.

4.2.2.2. Regional pattern

Between basins

The regional pattern revealed by the open **sea** species is rather large-scale and diffuse even if gradients do occur, e.g., from the Bothnian Bay to the Kattegat.

The large-scale regional pattern of the occurrence of **DDTs** and **PCBs** in herring and cod from the open sea basins is described by Jensen et al. (1969, 1972). In the 1960s the levels of chlorinated hydrocarbons were approximately five to ten times higher in the Baltic area than reflected by the reported sparse figures for comparable species in the North Sea and the Atlantic.

The regional pattern is, on the whole, verified by investigations reported by various authors in the two Periodic Assessments of the Baltic Sea Area (Slaczka et al., 1987, Svanberg et al., 1990). Bignert et al. (1992) state that the only biological matrix that, with a reasonable effect, can be used for spatial variations in the entire studied area is herring. For all organochlorines studied the highest values are found in the Baltic Proper and the lowest in the northern Gulf of Bothnia and at the Swedish west coast (Figure 40).

Studies on the harbour seal (*Phoca vitulina*) collected along the Swedish coast show significantly higher DDT and PCB concentrations in the Baltic compared to the Swedish west coast. Along the west coast the concentrations of DDT were significantly lower in the Skagerrak than in the Kattegat, whereas the PCB concentrations were the same in the two areas. The lowest levels of DDT and PCB were found in Scottish seals (Blomkvist et al., 1992). The harbour seal feeds to a large extent on demersal and littoral fish species and is in this respect a more coastal species than the grey and ringed seal.

The seal material was also analyzed for presence of polybrominated diphenyl ethers, toxaphene, and chlordanes. Also for these compounds the concentrations were found to be higher in Baltic seals than in seals from the Swedish west coast (Andersson et al., 1992). Surprisingly, the concentrations of polychlorinated dibenzo-para-dioxins (**PCDDs**) and dibenzofurans (**PCDFs**) were found to be similar in both west coast and Baltic seals and in both groups the concentrations were low (Bergek et al., 1992).

Recently, a contaminant, *Tris* (chlorophenyl) methane and *Tris* (chlorophenyl) methanol has been found in Baltic seals (Zook et al., 1992, Haraguchi et al., 1992). *Tris* (chlorophenyl) methane has earlier been found in predatory birds and mammals from North America. Sources are still unknown.

Figure 40.

Geometric mean concentrations and their 95% confidence interval at different sites for sDDT, sPCB, hexachlorbenzene (HCB), lindane and its isomers in herring. Arrows indicate a significant trend during the period (Bignert et al., 1992).

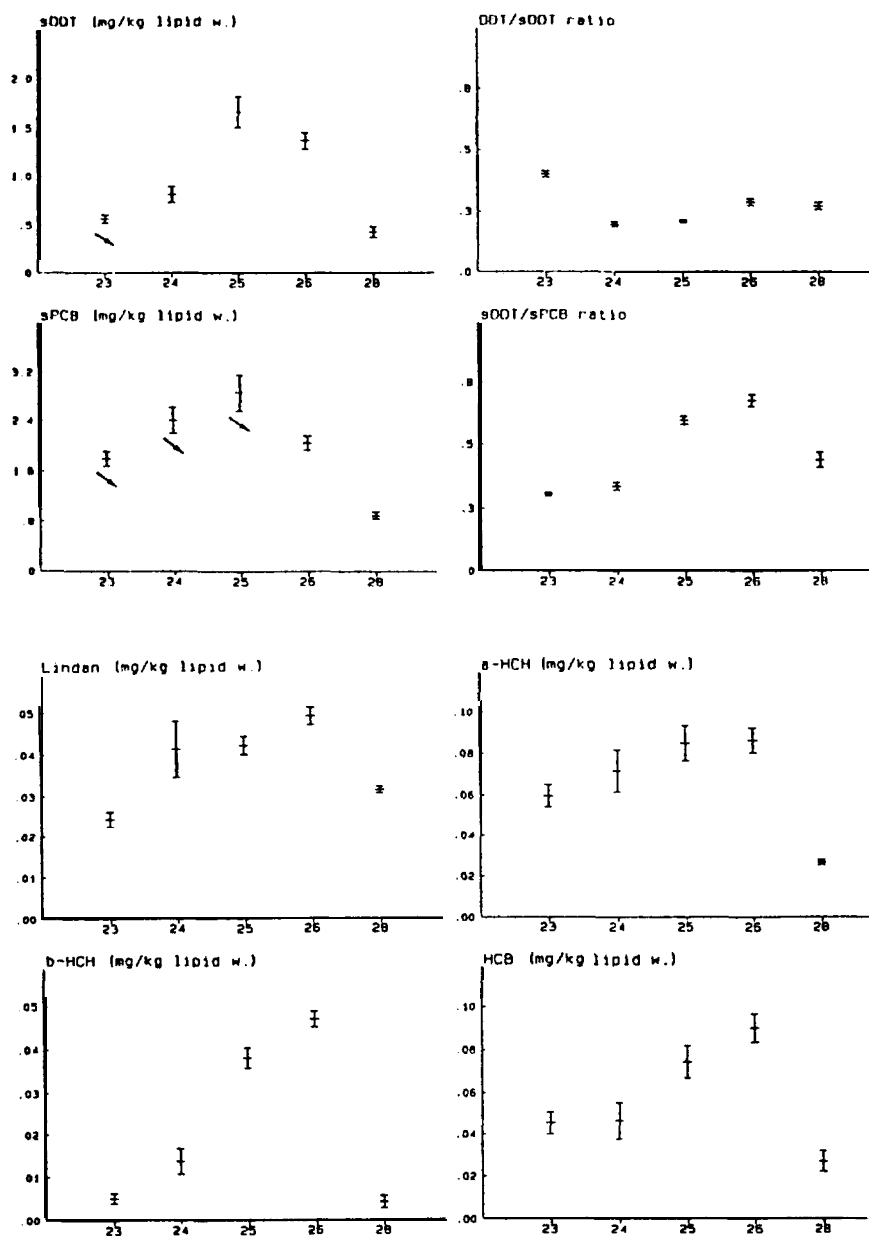

23 Bothnian Bay 25 North Baltic Proper 28 Kattegat
 24 Bothnian Sea 26 South Baltic Proper

The reasons for the elevated values in the brackish waters of the Convention are discussed in view of the actual disposal rate, characters and habits of species studied as well as general biological activities and hydrological conditions of the different regions considered. The assessments of the open waters as well as the results presented in this coastal assessment confirm that the animals of the Baltic live in one of the world's most heavily loaded sea areas (cf. Olsson, 1987).

Within basins

The possibility to distinguish a regional pattern within the basins depends on a series of information, including the knowledge of behaviour of the elements from species to **trophic** levels.

A regional study of pike and eel along the Swedish coast from the Skagerrak to the Bothnian Bay was performed in 1969-1971 (Jensen et al., 1977). No changes in the levels could be established during the three-year period. The two coastal species showed during that period approximately the same levels for both DDT and PCB substances within the whole Baltic area, in contrast to the pelagic species mentioned above where high DDT concentrations were recorded in the Baltic Proper. There are, however, relatively higher values observed **both** in pike and eel outside urbanized and **industrialized** areas.

Investigations on zooplankton by Miettinen & Hattula (1978) along the coast of Finland show that the PCB and total DDT concentrations were higher in the Gulf of Finland than in the Gulf of Bothnia. The results also reveal local areas polluted by industries and municipalities, e.g. off the large harbour of Kotka, the oil refinery of Porvoo, and the industries of Vaasa. There are rather similar values for areas close to the coast and the more open sea areas (Miettinen, pers. comm.).

The occurrence of DDTs and PCBs in the ecosystem of the Baltic Sea is summarized by Roots (1992), including, e.g., plankton. Investigations in 1978 (Roots and Peikre, 1981a,b) detected high values in the open part of the Baltic Proper and at the south-eastern part of the Baltic (cf. Falandyz, 1984). The lowest values are found in the coastal waters of Sweden, in the Gulf of Finland and the Gulf of **Riga** (Figure 41). No major changes in concentrations in the plankton communities can be detected in the material during the period of 1979-1984 (Roots and Saare, 1992). The same pattern for coast/open sea is shown for herring by Roots (1992), based on data from various authors.

In a study performed by Jankovski et al. (1984) there is a similar tendency of lower levels in the Gulf of Finland than in the open Baltic. Investigations by Trzosinska et al. (1981) show the same conditions with higher values in the open waters than in the coastal zone of Poland while Falandyz (1984) demonstrated high values of DDTs and PCBs in the mouth of the Gulf of Gdansk, comparable to those of some open water stations.

Analyses of DDT metabolites and PCBs in zooplankton, presented by Brügmann (1978) in zooplankton from the Gdansk Deep towards the western Baltic, show levels comparable to those presented by Roots & Peikre (1981). They seem, however, to indicate contamination in some areas by a more frequent shipping traffic off the Mecklenburg-Vorpommern coast.

Apart from locally contaminated areas, the message from the results presented is rather evident; lower values along the coastal zone than in the open waters. Such an effect of the increased density of organic material in the coastal waters and thereby a dilution of available elements, is discussed, e.g., by Neuman et al. (1988). It is also obvious that processes like eutrophication, alternatively oligotrophication, have to be taken into account when discussing concentrations and effects of potential toxic substances.

Figure 41. PCB and sDDT concentrations in plankton in September-October 1978 (Roots & Peikre, 1981).

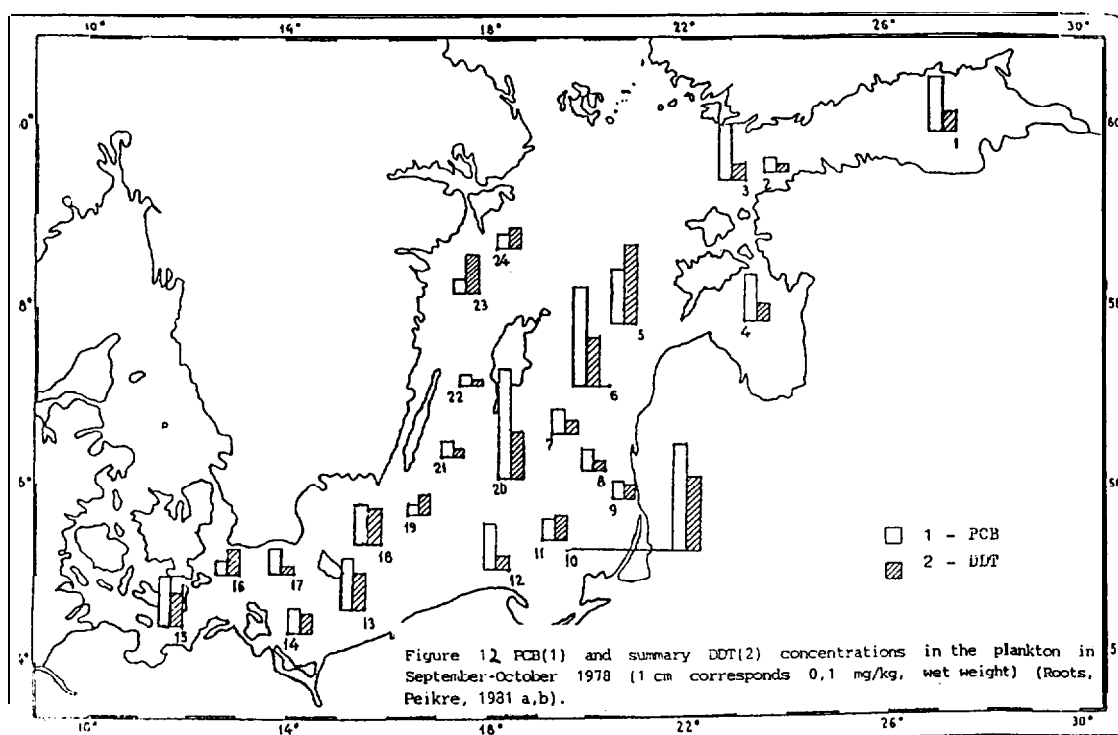
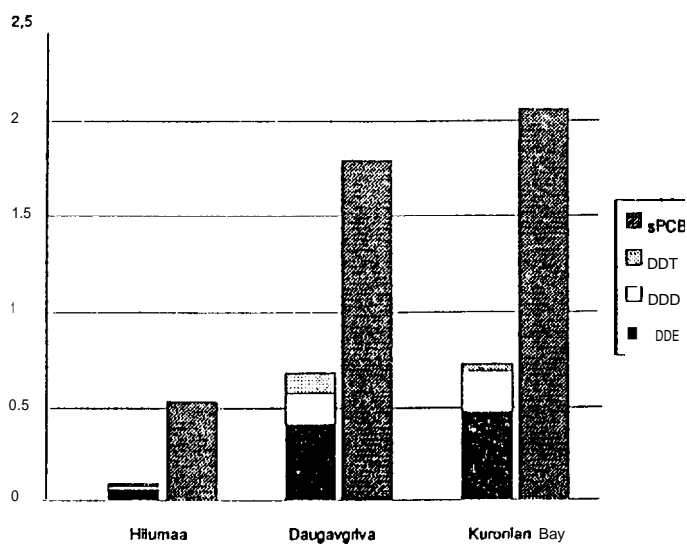

Figure 42. Concentrations of organochlorines in perch from various coastal areas of the Baltic Republics (Blomkvist et al., 1993).



Differences between coastal areas, indicated by levels in biota, are demonstrated by Blomkvist et al. (1993). Perch has been analyzed from localities south of Hiiumaa in Estonia, Daugavgriva in Latvia and Curonian Lagoon in Lithuania, sampled in September 1992. The concentrations found in perch from Hiiumaa showed very low concentrations (Figure 42). The mean concentrations of **sDDT** and **sPCB** were 0.09 and 0.53 **mg/kg** (lipid weight) respectively. Corresponding concentrations in perch from the Swedish reference area in the Baltic Proper are 0.53 and 2.08 respectively. The concentrations found at the Latvian and Lithuanian coasts are similar to those found at the Swedish reference area. It is pointed out that eutrophication, especially in the Curonian Lagoon, indicates an even larger difference in local contamination than what can be seen from the concentration data.

Differences between areas are also indicated by analyses of aquatic vegetation along the Estonian coast (Talvari et al., 1992). The material includes eight species from 23 sampling stations and is presented in Table 14. The material is here sorted out in 6 subareas and 3 main areas. The subareas 1 (northern Estonian coast) and 2 (outside Saaremaa) constitute Area I; subareas 3 (Kassaar) and 4 (Haapsalu region) are included in Area II, and subareas 5 (inside Saaremaa) and 6 (**Pärnu**) are summarized in Area III.

Table 14. DDTs and PCBs in aquatic vegetation from 23 sampling stations in three main areas coastal areas 1988-1989. Area I: open coast Gulf of Finland and outer Saaremaa. Area II: north-west archipelago, Haapsalu-Kassaar. Area III: Gulf of **Riga** inside Saaremaa plus **Pärnu** area. In **µg/kg** dry weight (Talvari et al., 1992).

Species	Area I			Area II			Area III		
	DDT	PCB	Q	DDT	PCB	Q	DDT	PCB	Q
<i>Cladoph. glom.</i>	2.4	29.3	0.08	4.3	43.4	0.10	1.2	32.2	0.04
<i>Enterom. int.</i>	2.0	38.0	0.05	4.4	39.7	0.11	5.6	49.4	0.11
<i>Fucus vesic.</i>	2.4	27.1	0.09	2.8	32.7	0.09	1.0	21.0	0.05
<i>Furcell. lumb.</i>	2.4	21.8	0.11	3.5	27.3	0.13	2.3	28.2	0.08
<i>Ceram. ten.</i>	3.6	23.2	0.16	6.0	38.8	0.15			
<i>Rhodom. con.</i>	4.3	55.3	0.08						
<i>Ranunc. ba.</i>	4.1	56.2	0.07						
<i>Potamog. fir.</i>	1.4	28.5	0.05						

It should be noted that PCB concentrations in all investigated samples are substantially higher than DDT concentrations. The complex material (different species and localities) makes further interpretation of the data difficult.

4.2.2.3. Species pattern

The amount of information in a more detailed, regional scale is limited, especially illustrating the differences between coastal and open sea areas. It is, however, possible to find indications of gradients by means of the material available from studies of coastal areas and their species, e.g., algae, benthic animals or stationary fish species.

The concentrations of **DDTs** and **PCBs** vary between species. The example of analyses on macroalgae, given in Table 14 is further elaborated in Table 15, which indicates that the mean concentration of **DDTs** and **PCBs** observed is two times higher in green algae (*Cladophora* and *Enteromorpha*) compared to the brown algae (*Fucus*) and red algae (*Furcellaria*, *Ceramium* and *Rhodomenas*).

The conditions are reflected in Figure 43, which is based on *Cladophora*, *Fucus*, *Furcellaria*. Four samples with high concentrations of **DDT/PCB** are represented by *Cladophora* from the island Vorms. The remaining two samples with high concentrations are algae from **Nommküla** at the northern part of the island Muhu, where samples were taken in vicinity of a small harbour of local importance (**Kukk**, pers. comm.). A revisit is planned for confirmation of results.

Table 15. The mean concentrations of **DDTs** and **PCBs** in algae from the Estonian coastal areas, 1988-1989 (Data from Talvari et al., 1992). In $\mu\text{g}/\text{kg}$ dry weight.

Algae	n	PCBs		DDTs	
		mean	range	mean	range
Green algae	12	46.2	20.0-78.6	4.5	2.0-10.2
Brown algae	19	27.4	17.0-45.6	2.1	0.8- 6.5
(excl. Nommkiila)	18	27.2	17.0-45.5	1.9	0.8- 3.9
Red algae	17	26.5	10.8-55.3	2.8	0.8- 8.0
(excl. Nommküla)	16	25.7	10.8-55.3	2.5	0.8- 6.0

A series of macroalgae and phanerogams has been analyzed at several areas of the Estonian coast from 1983-1987 (Kukk et al., 1990) and indicates the same conditions; a large variation between species and seasons. Concentrations of **PCBs** (2700 ppb lipid weight) in *Fucus* from the Stockholm archipelago in October 1969 (Olsson et al., 1972) indicate the same levels reported by Roots & Kukk (1988) but lower values than those mentioned by Kukk et al. (1990).

Figure 43. The concentrations of **DDTs** and **PCBs** in *Cladophora*, *Fucus* and *Furcellaria* from various areas of the Estonian coast (data from Talvari et al., 1992).

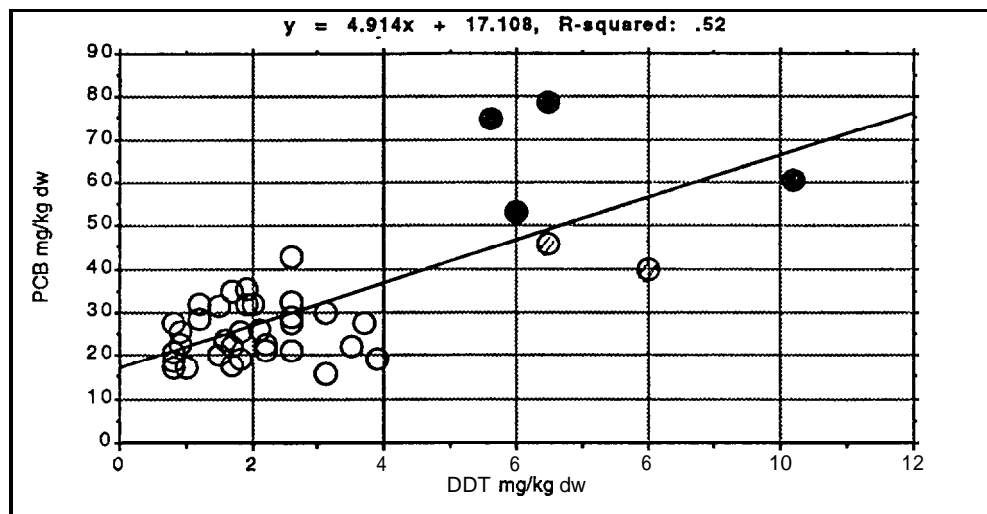

● green algae, island of Vorms
 ○ 6 algae at **Nommküla**, island of Muhu

A similar overview for mussels is given by Roots (1981). The two main mussels are *Mytilus edulis*, which is a **filtrator** and reflects the availability of elements bound to the particles in the free water mass, and the *Macoma baltica*, living in and on the material in the sediment surface. There is a small difference with higher concentrations in the *Macoma*, e.g. in the open water areas or in the Gulf of Gdansk (Table 16). Without knowledge of the span of variability there seem to be areas in the Tallinn Bay indicating higher values of **DDTs** and **PCBs** compared to other water areas. Nonetheless the seasonal variation in the availability of food for the species of mussels measured, e.g. as the density of and load in organic particles, has to be studied in order to understand the results obtained from these bioindicators.

Looking at the mean concentrations of **DDTs** and **PCBs** at the two steps of **trophic** levels, from primary producers to consumers, there are about **5-10** times higher levels in the consumers.

The concentrations per kg wet weight vary between fish species and are relatively low in fish and high in seal, which is illustrated in Table 17.

Table 16. DDTs and PCBs in mussels from the Baltic during 1974-76. In $\mu\text{g}/\text{kg}$ wet weight.

Species	Area	Year	DDTs	PCBs
<i>Mytilus edulis</i>	Tallinn Bay, stn 2	1976 *	94	109
	Tallinn Bay, stn 3	1976	26	33
	Gulf of Gdansk	1975 **	34	40
<i>Macoma baltica</i>	Gulf of Bothnia	1974 ***	38	39
	Gulf of Bothnia	1979 ****	22	82
	Gulf of Finland	1974 ***	35	51
	Gulf of Finland	1979 ****	22	77
	Tallinn Bay, stn 1-2	1976 *	102	113
	Tallinn Bay, stn 3-4	1976 *	41	38
	Gulf of Gdansk	1975	70	48
<i>Cardium edule</i>	Tallinn Bay, stn 4.	1976 *	16	28

(* = Roots 1981, ** = Trzosinska et al. 1975, *** = ICES 1977, **** = Tervo et al. 1980).

Table 17. The concentrations of DDTs and PCBs in various species in biota of the Baltic in 1966-68. In $\mu\text{g}/\text{kg}$ wet weight (ww) and lipid weight (lw) + percentage fat in muscle (Jensen et al. 1969).

Area	Species	DDTs		PCBs		% fat
		ww	lw	ww	lw	
Gulf Bothnia	herring	260	6200	65	1500	4.4
	seal	63000	120000	6800	13000	54.0
Stockh.arch.	herring	230	7700	170	5100	2.6
	seal	36000	170000	6100	30000	27.1
South. Baltic	plaice	18	2700	17	2700	0.65
	cod	63	19000	33	11000	0.32
	herring	680	17000	270	6800	4.4
	salmon	3400	31000	300	2900	11.0
	seal	66000	130000	15000	30000	52.0

Since lipophilic compounds in water will behave according to the chemical partition water/lipids (Duinker, 1992), the concentration of lipophilic compounds in gill-breathing animals is a result of bioaccumulation and only partly a result of biomagnification through food chains. In air-breathing animals the concentrations are, predominantly, a result of biomagnification by food ingestion. Thus, a proper food chain accumulation, based on the marine biosystem, can only be expected among birds of prey and mammalian predators. Such a close relationship is demonstrated in Figure 39.

A complication in the study of bioaccumulation processes in water-living organisms is that a proper fat determination is needed to examine the rate of accumulation. Concentrations of lipophilic contaminants on fresh weight and dry weight basis give a false description of the partition process water/lipids of the biota.

Table 18 summarizes the concentration DDE and PCB in a coastal area, Kiel Bay March-June 1990 (Duinker, 1992). The results show that there is no increase along the food chain as far as water-breathing biota is concerned.

Table 18. DDE and PCBs in various compartments and trophic levels in the Kiel Bay, March-June 1990. Concentrations in water from four sampling dates during two months (summarized after Duinker, 1992).

Object	DDE	PCBs	Comments	
Water, pg/l	17 - 1.2 - 0.4 - 0.2	563 - 63 - 20 - 7	March-April	
Sediment $\mu\text{g}/\text{kg}$ org. C	0.43-0.70	42-53	org C in % 0.74-0.41	
	$\mu\text{g}/\text{kg}$ lipid	$\mu\text{g}/\text{kg}$ lipid	% lipid	
Plankton				
phytoplankton	38	781	0.31	diatoms
zooplankton	49	488	1.7	copepods
Invertebrates				
<i>Artica isl.</i>	80	572	0.73	mussel
<i>Crangon cr.</i>	26	953	0.76	crustacean
<i>Nephtys sp.</i>	75	1674	0.91	polychaete
Fish				
flounder	53	697	0.45	muscle
herring	324	1398	7.0	muscle
herring	379	5100	0.53	gonads
Porpoise	2558	7511	90	blubber

In Table 19 concentrations of DDT and PCB found in various fish species collected at the Swedish coast of the central Baltic Proper are summarized. Neither here is there an obvious biomagnification through the food web.

Table 19. DDTs and PCBs in fish species from the area of **Kvädöfjärden** at the central Baltic coast of Sweden during 1969-1971. In $\mu\text{g}/\text{kg}$ wet weight (ww) and lipid weight (lw) (Jensen et al. 1972, 1977, Persson, W., personal comm.).

Species	DDTs		PCBs		96 fat
	ww	lw	ww	lw	
Cod	24	2700	59	6800	0.5-1
Pike	103	20000	74	14000	- 1
Flounder	110	8600	150	12000	< 1
Eel	350	2900	200	1600	10-20
Herring	890	26000	577	19000	2-4
Salmon	3500	28000	1000	8300	- 1 0

Taking the step from marine animals to fish-eating birds, the development of the levels of DDE and PCBs in guillemot eggs is reported by Olsson and Reutergårdh (1986), and Odsjö and Olsson (1989). This species represents a food web mainly based on open sea herrings. From other species like the blackheaded gull (*Lams ridibundus*), living to some extent on coastal fishes, high values of DDE and PCBs in eggs are reported, e.g. from the German coast (Holz and Starke, 1990). Most of the measured residue values exceeded the limits for egg consumption by man.

The Eurasian otter (*Lutra lutra*) is another top predator which reflects the negative effects of organochlorines in the Baltic. This mammal is more representative for the coastal zone than, e.g. the seals. As an example can be mentioned that cyprinids, which mainly occupy the coastal zone, belong to the preferred food objects for otter. There is an obvious decline of the otter populations along the coasts and PCB is supposed to be of specific importance among the toxic substances to be considered as active. There are reasons to believe that eutrophication has benefitted otter survival in areas exposed to airborne pollutants. In both northern and southern Sweden, the few remaining otter populations are found in waters with comparatively large amount of nutrients (eutrophic waters) caused either by natural high quality of mineral background or by released nutrients from urban districts or agricultural activities (Olsson & Sandegren, 1991).

4.2.2.4. Seasonal pattern

The concentrations of organochlorines in water are reported in some national reports for this coastal assessment, in Assessments of the Open Baltic, or presented by several specialists (personal communication). A general figure mentioned is about 1 ng/l of chlorinated biphenyls in the water phase.

Figure 44. The concentrations of **PCBs** at the depth of 3m in sea water on four sampling occasions at the Boknis Eck in the Kiel Bay, 1990 (Duinker, 1992).

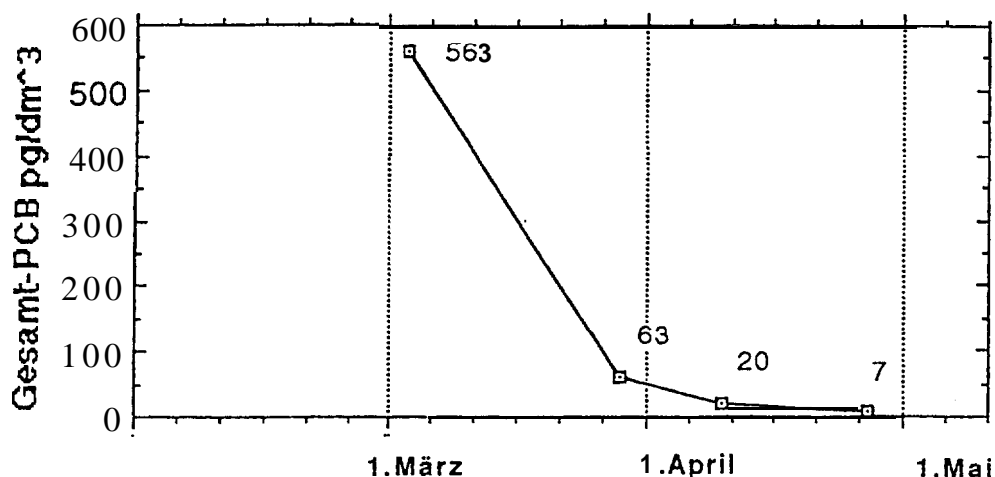

An investigation in Kiel Bay performed by Duinker (1992) shows lower values and a very rapid decrease of the chlorinated biphenyls (39CB) in sea water from 560 **pg/l**, over 63 and 20 **pg/l** down to 7 **pg/l** going from March to April 1990 and below the detection limits at the end of the period (Table 18, Figure 44). This **100-fold** reduction is related to the uptake by the plankton bloom followed by sedimentation of the suspended organic compounds.

The rapid changes of concentrations in water have effects on the biosystem. The results illustrate the problems involved in the interpretation of differences in time and space found in biota. Nonetheless, some main patterns revealed by studies and of importance for understanding the situation in the coastal zone are revealed.

Benthic macrophytes studied during 1983-87 at the northern and western coast of Estonia (Kukk et al., 1990) indicate higher values of chlororganic compounds in the green and brown algae in summer than in the autumn.

The seasonal variation of **DDTs** and **PCBs** has been followed in perch and roach collected at the Swedish Baltic coast by Edgren et al. (1981). The results show stable levels during late summer and autumn but substantially and significant higher levels during spring and early summer in both species (Figure 45). It was also shown that the levels were significantly higher in perch from the area affected by cooling water effluents from the nuclear power station in the area (Simpvarp).

The same seasonal pattern of PCB in roach has been established in a seven-year study in a Swedish lake (Olsson et al., 1981), where the increased levels were correlated to the spring flow of the rivers entering the lake.

The variation has been followed up in Baltic herring (Olsson & Reutergårdh, 1986), where field data show generally higher organochlorine levels in the lipids in spring samples than in those collected during autumn.

In a study on the viviparous blenny (*Zoarces viviparus*) a substantial increase of PCB was found in sexually mature females during the reproduction period in September-October (Jacobsson et al., 1993).

Figure 45. Seasonal variation in DDTs (a) and PCBs (b) in perch muscle (upper part) and roach muscle (lower part) from the coast of Simpvarp, Central Baltic Proper, Sweden. In mg/kg extractable fat (Edgren et al., 1981).

Symbols used in figures 1 and 2, • Fish from intake area, x Fish from cooling water recipient. 0 Less than 6 specimens analysed, | 95% confidence interval, --- Hatched line represents lack of monthly mean values.

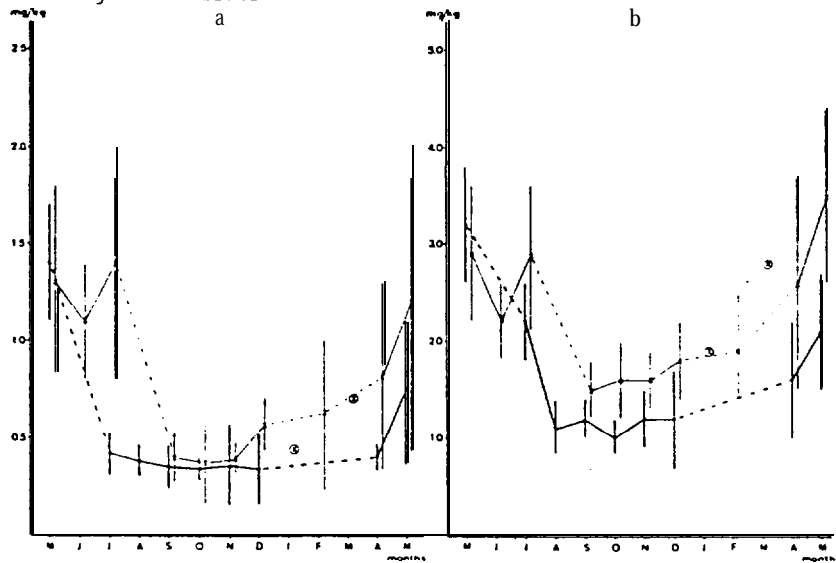

Figure 1. Monthly mean values and 95% confidence interval for the a) sCOT and b) PCB levels in extractable fat from perch muscle.

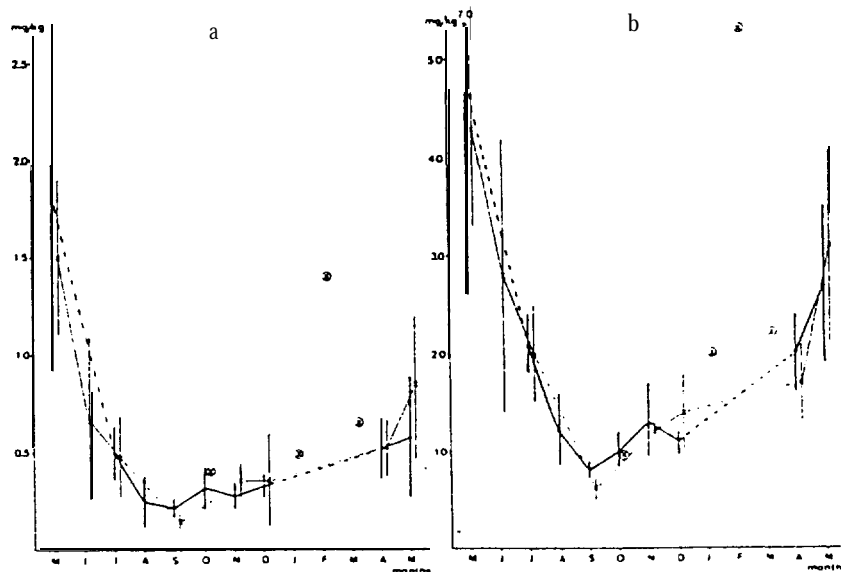

Figure 2. Monthly mean values and 95% confidence interval for the a) sCOT and b) PCB levels in extractable fat from roach muscle.

4.2.3. Specific items

4.2.3.1. Experiences from local sources

Effluents from bleached pulp mills are regarded as being an important source of chlorinated **organics**. The environmental fate of these effluents is summarized in two reports from Swedish projects, edited by **Södergren** (1989 and 1992). The publications cover specific items from chemical characteristics of the effluents to various effects in the environment.

More than one hundred specific organic compounds, both chlorinated and non-chlorinated, are identified and quantified together with environmental parameters like total organic chlorine (**TOCl**) and adsorbable organic halogen (**AOX**) (Dahlman et al., 1992). Chloroguaiacols from bleach-plant effluents were present at all sampling sites in the Baltic Sea and the concentration of **AOX** was found to vary between 6 and 20 $\mu\text{g Cl/l}$ (Jonsson et al., 1991). A budget calculation of extractable organic chlorine (**EOCl**) for the Baltic Sea indicates that the input via precipitation is a major source, possibly of similar magnitude to that released from pulp mills (Södergren et al., 1992).

It is pointed out that the complex composition of the effluents makes a complete chemical **characterization** almost impossible and that the difficulties are even more pronounced when compounds taken up by organisms are to be identified. There are, however, observations advocating toxic effects in the environment.

Mesocosm experiments demonstrate the sensitivity of, e.g. bladder wrack (*Fucus*), to low concentrations of chlorate from the bleaching process of paper pulp (Lehtinen et al. 1988, Rosemarin et al., 1986, 1990 a). The results from these experiments also show invertebrates, especially crustaceans, are highly sensitive to chlorophenolic **4,5,6-trichloroguaiacol** (Rosemarin et al., 1990 b).

There are observations in the field at various **trophic** levels, e.g. on algae, mussels, crustaceans and fish (Kautsky, H., 1992, Sundelin, 1992). Some of them are referred to on fish by Neuman & Karås (1988). Other examples of effects on fish are biochemical and physiological responses (Förlin et al., 1992). These are exemplified by an induced EROD activity, detected not only close to the bleached pulp mills (2-5 km) but also at a remote area more than 20-40 km from the discharge point. A regional or even a possible large-scale biological response in the Baltic Sea is suggested.

Very high **prevalences** of fin erosion (66%), together with deformity of the gill cover (20%), was found on perch in Swedish bleached pulp mill effluents located in the Gulf of Bothnia in the mid-1980s. A high percentage (35%) of deformity of the upper jaw of northern pike was also found. In reference areas none of these diseases was found at a prevalence exceeding 3% (Lindesjö & Thulin, 1990, Lindesjö, 1992). After improvement of the industrial processes, these negative effects have disappeared.

4.2.3.2. Polychlorinated dibenzo-p-dioxins and dibenzofurans (PCDD/PCDF) and planar PCB in organisms from the Baltic Sea

Polychlorinated dibenzo-p-dioxins and polychlorinated dibenzofurans (PCDD/PCDF) make up a family consisting of 210 different substances, also called congeners. These molecules can contain from 1 to 8 chlorine atoms at different positions on the dioxin or furan skeleton. Of these 210 chemicals, 17 are considered extremely toxic. These all contain at least 4 chlorine atoms placed in the 2,3,7 and 8 positions on the molecule. The most toxic congener is 2,3,7,8-tetrachlorinated dibenzo-p-dioxin, TCDD. The concentrations of dioxins in the environment are most often expressed as pg/g (a picogram is 10^{-12} gram) which is the same as parts-per-trillion (ppt).

Within the Swedish Dioxin Survey, numerous biological samples have been analyzed for the 17 most toxic polychlorinated dibenzo-p-dioxins and furans (PCDD/PCDF). A large number of samples have been taken in and around the Baltic Sea (see Figure 46). Some of these results have recently been published (de Wit et al., 1992). To simplify things, the concentrations of the 17 toxic dioxins and furans can be expressed as their weighted sum. These substances have similar toxic effects but different potencies and the weighting used is based on each compound's toxicity compared to 2,3,7,8-tetrachlorinated dioxin (TCDD), the most toxic congener. The sum is expressed as TCDD-equivalents (TEQ), and within the Swedish Dioxin Survey, the Nordic model is used (Table 20).

Several PCB congeners which are dioxin-like (the so-called planar PCBs) have also been analyzed in some samples. These PCBs are 3,3',4,4'-tetrachlorinated biphenyl (PCB 77), 3,3',4,4',5-pentachlorinated biphenyl (PCB 126), 3,3',4,4',5,5'-hexachlorinated biphenyl (PCB 169), 2,3,3',4,4'-pentachlorinated biphenyl (PCB 105) and 2,3',4,4',5-pentachlorinated biphenyl (PCB 118). There is as yet no unified system for expressing these substances as TCDD-equivalents but for the interim, we use the weightings given by Hanberg et al. (1991) (Table 2 1).

Samples analyzed include the following fish species: herring, pike, burbot, whitefish and cod. The following fish-eating birds have been studied: guillemot, white-tailed sea eagle and osprey and the mammals included were grey, common and ringed seal and common porpoise. The samples were collected from different sites along the Swedish side of the Baltic Sea. The collection sites represent hot spots, less industrialized areas and background stations within the Swedish Environmental Monitoring Programme.

Generally speaking, concentrations of PCDD/PCDF and planar PCBs in living organisms are higher in the Baltic Sea, compared to Kattegat and Skagerrak.

PCDD/PCDF and planar PCBs, like other organochlorines, are lipophilic and concentrate in the fatty tissues of living organisms. It is therefore possible to express their concentrations in a tissue in two ways - on a fresh weight (fw) basis or on a lipid weight (lw) basis. Fresh weight levels are important when one is determining human intake of these substances via food for example. The fresh weight PCDD/PCDF concentrations will be dependent on the fat content of the tissue or organism one is studying. Fatty fish such as herring and salmon will have higher fresh weight concentrations than leaner fish such as cod and pike.

Figure 46. Overview of sampling sites.

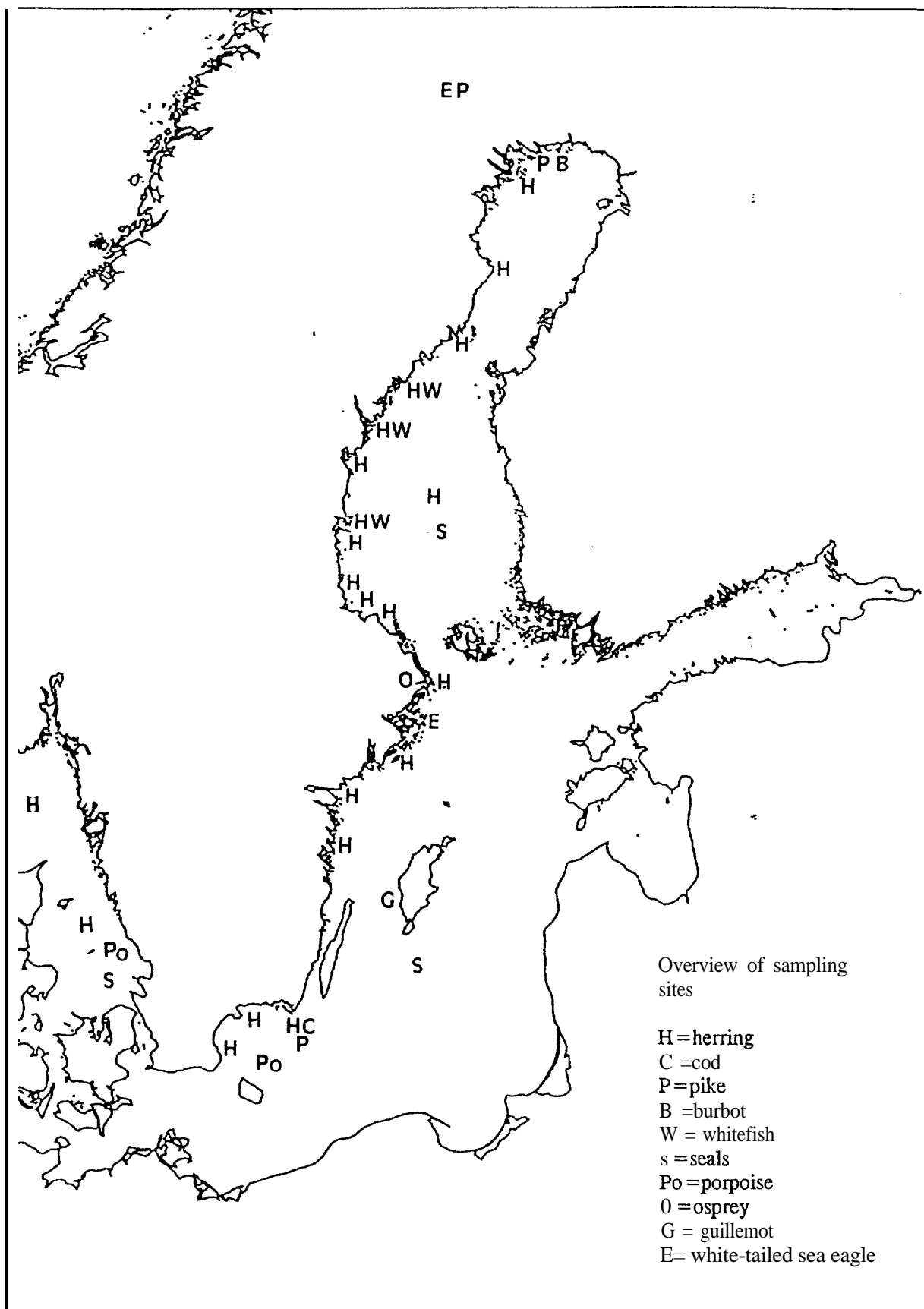

Lipid weight levels are used when comparing concentrations in different organisms or different tissues within an organism. This makes it possible to draw conclusions on whether the levels in a particular area are elevated as well. For example, comparisons can be made between the lipid weight concentrations of PCDD/PCDF in fish and birds to study biomagnification in fish-eating birds.

Table 20. TCDD equivalency factors for different dioxin and **furan congeners** according to a Nordic expert group.

	Equivalency factor
Dioxins	
2,3,7,8-TeCDD	1
1,2,3,7,8-PeCDD	0.5
1,2,3,4,7,8-HxCDD	0.1
1,2,3,6,7,8-HxCDD	0.1
1,2,3,7,8,9-HxCDD	0.1
1,2,3,4,6,7,8-HpCDD	0.01
OCDD	0.001
Furans	
2,3,7,8-TeCDF	0.1
1,2,3,7,8-PeCDF	0.01
2,3,4,7,8-PeCDF	0.5
1,2,3,4,7,8-HxCDF	0.1
1,2,3,6,7,8-HxCDF	0.1
1,2,3,7,8,9-HxCDF	0.1
2,3,4,6,7,8-HxCDF	0.1
1,2,3,4,6,7,8-HpCDF	0.01
1,2,3,4,7,8,9-HpCDF	0.01
OCDF	0.001

Abbreviations:

Te = tetra

Pe = penta

Hx = **hexa**

Hp = hepta

o = octa

CDD = chlorinated dibenzodioxin

CDF = chlorinated **dibenzofuran**

Fish

Herring

There are several factors that affect the concentrations of **PCDD/PCDF** and planar **PCBs** in herring. These include the season collected, age and size. Herring collected in the spring have a lower fat content than those collected in the fall. This leads to higher lipid weight **PCDD/PCDF** concentrations in the spring herring since the dioxins are concentrated in a smaller amount of fat. Concentrations are fairly similar on a fresh weight basis between spring and fall herring, however. Age and size have also been found to play a role. Younger fish have lower **PCDD/PCDF** concentrations than older fish and smaller fish have lower concentrations than larger fish. This makes comparing results a bit more difficult since higher concentrations may not necessarily mean that the particular collection site has higher levels, only that bigger fish have been analyzed.

Table 21. TCDD equivalency factors for specific planar **PCBs** according to **Hanberg et al. (1991)**.

PCB	PCB number	Equivalency factor
3,3',4,4'-TeCB	77	0.001
3,3',4,4',5-PeCB	126	0.1
3,3',4,4',5,5'-HxCB	169	0.005
2,3,3',4,4'-PeCB	105	0.00009
2,3',4,4',5-PeCB	118	0.000002

Abbreviations:

Te = tetra

Pe=penta

Hx = hexa

CB = chlorinated biphenyl

Fifty herring homogenates from different collection sites along the Swedish coast of the Baltic Sea have been analyzed for **PCDD/PCDF** and 17 of these have been analyzed for planar **PCBs**. The majority of these samples were taken close to the coast. One sample was taken in the middle of the Bothnian Sea.

PCDD/PCDF concentrations are fairly similar from north to south (Table 22). There seems to be a slight increase in concentrations along the coast of Norrland, where numerous **kraft** pulp mills are located. The herring samples from this stretch of coast also contain higher relative levels of **TeCDF** and **TeCDD**, two specific **PCDD/PCDF** that are associated with effluents from paper bleaching. The sample from the middle of the Bothnian Sea contained 8.7 pg **TEQ/g** fw (190 pg **TEQ/g** lw). Herring collected from Kattogat and Skagerrak have much lower levels.

Table 22. TCDD-equivalents in herring.

<u>Area</u>	Concentration (pg TEQ/g) Fresh weight basis		Concentration (pg TEQ/g) Lipid weight basis	
	<u>Average</u>	<u>Range</u>	<u>Average</u>	<u>Range</u>
Entire Baltic	9.5	2.1-20	150	27-420
Norrlands Coast	12	5.4-20	160	88-260
Kattegat-Skagerrak	19	1.8-2.1	24	9.1-52

Planar PCB TEQ for the 17 Baltic herring samples analyzed are comparable to the PCDD/PCDF TEQ. This means that the planar PCBs may be just as important when adding up the dioxin-like toxicity of contaminants in herring. For example, the average PCDD/PCDF TEQ for these 17 samples is 9.7 pg/g fw (160 pg/g lw) and the average planar PCB TEQ for the same samples is 9.3 pg/g fw (150 pg/g lw). For comparison, the PCB TEQ for herring from Kattegat/Skagerrak is 2.1 - 2.9 pg/g fw.

Fall herring of different age classes were analyzed from the environmental monitoring station at Utklippan. PCDD/PCDF and planar PCB concentrations increase with the age of the herring. Two-year-old fall herring had PCDD/PCDF concentrations of 26 pg TEQ/g lw, 4-year-olds had 60 pg TEQ/g lw and 6-year-olds had 75 pg TEQ/g lw (Figure 47). The same trend is seen in herring of different consumption sizes. For example, fall herring samples taken near Gryt and separated into 4 size classes had concentrations of 55, 75, 130 and 160 pg TEQ/g lw for small, medium, large and extra large herring (Figure 48).

Figure 47. Concentrations in fall herring, Utklippan.

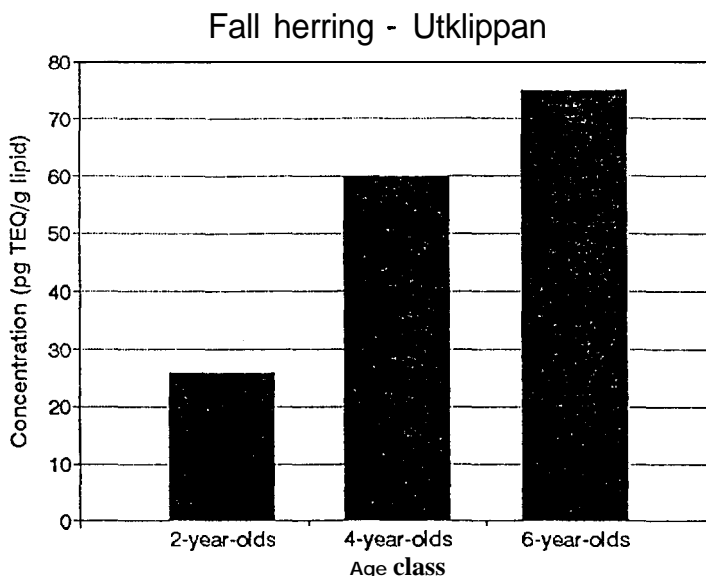
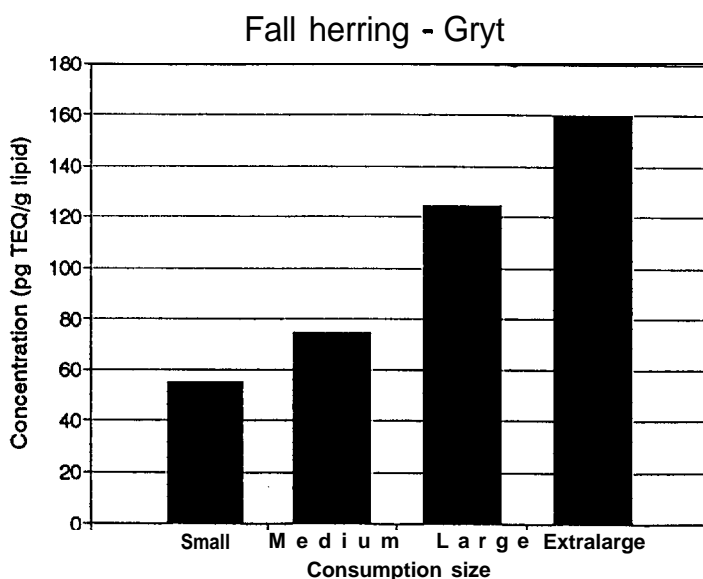

Figure 48. Concentrations in fall herring, Gryt.



This bioaccumulation is probably due to increased exposure since older/larger herring migrate over larger areas of the Baltic Sea than young herring. Young herring are more stationary and their concentrations reflect a more local situation. This characteristic has been used within the Swedish Environmental Monitoring Program. To study geographical trends, 2-year-old fall herring from 5 monitoring stations were also analyzed for PCDD/PCDF. These stations have been chosen to represent background levels in the Baltic Sea and are as far from local sources as possible. The stations are at **Harufjärden** (Bothnian Bay), **Ångskär** (Bothnian Sea), Utklippan (Baltic Proper), Fladen (Kattegat) and **Väderöarna** (Skagerrak).

PCDD/PCDF concentrations from these samples are understandably lower than those in the previously mentioned samples. The range for the Baltic stations is 0.59 - 1.1 pg **TEQ/g** fw, 23 - 38 pg **TEQ/g** lw and for **Kattegatt/Skagerak** the range is 0.28 - 0.35 pg **TEQ/g** fw, 6.8 - 9.9 pg **TEQ/g** lw (Figure 49). These results confirm that PCDD/PCDF concentrations are higher in the Baltic Sea than in **Kattegat/Skagerrak**.

Cod

Homogenates of cod muscle and liver taken from the same individuals were analyzed for PCDD/PCDF and planar PCB. The fish were collected at Utklippan in the Baltic Proper which is a background station within the Swedish Environmental Monitoring Program. Cod muscle is very lean while the liver is very rich in fat. The fresh weight PCDD/PCDF concentrations are 0.36 pg **TEQ/g** muscle and 38 pg **TEQ/g** liver. For planar PCB the values are 1.2 pg **TEQ/g** muscle and 130 pg **TEQ/g** liver. On a lipid weight basis PCDD/PCDF concentrations are 60 pg **TEQ/g** muscle and 53 pg **TEQ/g** liver and planar PCB concentrations are 130 pg **TEQ/g** muscle and 190 pg **TEQ/g** liver.

Figure 49. Concentrations in 2-year fall herring from five stations.

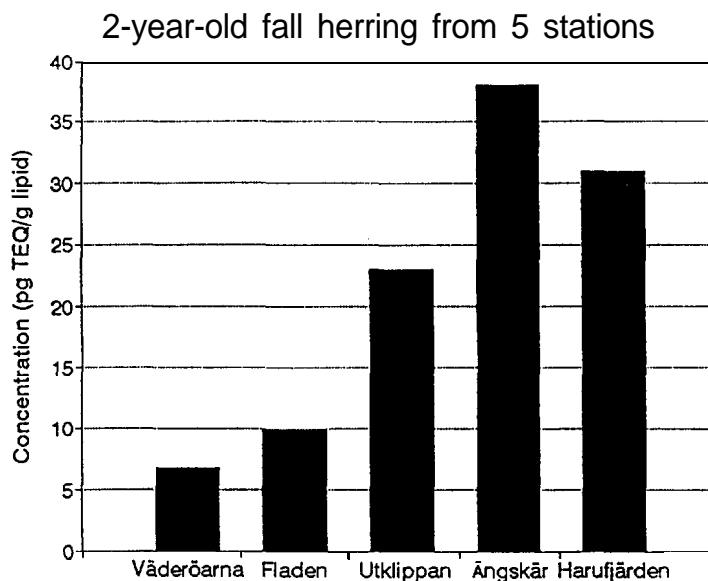

Pike and burbot

Average PCDD/PCDF concentrations in 2 pike homogenates from Utklippan in the Baltic Proper are 0.49 pg **TEQ/g** fw and 100 pg **TEQ/g** lw.

A study was conducted along the northern coast of the Bothnian Bay which included PCDD/PCDF analyses of both pike (muscle) and burbot (liver) homogenates. The fish were collected at the mouths of 3 rivers (**Råne älv**, **Kalix älv**, **Tome älv**) of which 2 have heavy industries (pulp bleaching at Kalix, ferrochrome works at Tom&). Burbot from around **Tome älv** have reduced fertility. The concentrations are given in Table 23. The general conclusion was that PCDD/PCDF concentrations can not explain the reduction in fertility at **Torneå**.

Table 23. TCDD-equivalents in pike muscle and burbot liver from three rivers.

<u>River</u>	<u>Concentration in pike (pg TEQ/g)</u>		<u>Concentration in burbot (pg TEQ/g)</u>	
	<u>Fresh weight basis</u>	<u>Lipid weight basis</u>	<u>Fresh weight basis</u>	<u>Lipid weight basis</u>
Råne älv	1.0	330	77	190
Kalix älv	1.9	330	82	180
Tome älv	1.3	320	67	130

Whitefish

Three whitefish homogenates were collected along the Bothnian Sea coast. The average PCDD/PCDF concentration was 7.3 pg **TEQ/g** fw and 160 pg **TEQ/g** lw. For planar PCB the concentrations were 4.2 pg **TEQ/g** fw and 94 pg **TEQ/g** lw.

Seals

Seal blubber homogenates were analyzed from common seal (Baltic Proper, Kattegat), ringed seal (Bothnian Bay, Arctic), and grey seal (Baltic Proper). Ringed seal from the Arctic included samples from each sex and different age groups. Ringed seal from the Bothnian Bay included samples from yearlings and adult females. Most other samples were taken from yearlings.

Dioxin levels in seals are similar independent of sampling site, sex or age, about 15-25 ppt TEQ on a lipid weight basis (Bignert et al., 1989; Bergek et al., 1992). These PCDD/PCDF levels are fairly low and indicate that seals do not seem to biomagnify these substances. These levels can be compared to those in herring, a major part of the diet of many seal species. Herring from the Baltic Proper have average **PCDD/PCDF** levels around 110 ppt TEQ on a lipid weight basis. The dioxin-like planar PCB (PCB 77, 126 and 169) also do not seem to biomagnify in seals, whereas other **PCBs** do (**PCB** 105, 118 and total PCB). This indicates that seals are able to metabolize PCDD/PCDF and planar PCB and eliminate them (Figure 50).

Other species

In general, PCDD/PCDF do not seem to biomagnify to any large degree in the common porpoise, similar to the finding for seals. The **PCDD/PCDF** concentrations are about 1-4 ppt TEQ lipid weight in porpoise blubber from the **Kattegat/Skagerrak** and 6-7 ppt TEQ in individuals from the Baltic Proper. No relationship was seen between PCDD/PCDF concentrations and age or sex. These levels are much lower than in the herring the porpoises eat (Figure 50). The planar **PCBs** (**PCB** 77, 126 and 169) do not biomagnify, either whereas **PCB** 105 and 118 do.

Fish-eating birds do seem to biomagnify **PCDD/PCDF** and PCB however. The levels in guillemot, osprey and white-tailed sea eagle are much higher than in fish (Figure 50). Guillemot eggs collected in 1990 from the island of Stora **Karlsö** in the Baltic Proper have PCDD/PCDF concentrations of 1100 pg **TEQ/g** lw and the planar PCB TEQ is 5000 **pg/g** lw. Compared to Baltic herring, guillemot eggs contain approximately 13 times as much PCDD/PCDF TEQ and 42 times as much planar PCB TEQ.

PCDD/PCDF concentrations in white-tailed sea eagle eggs from the Baltic Proper (Stockholm archipelago) are 2700 pg **TEQ/g** lw and planar PCB TEQ is 13 000 **pg/g** lw. This is about 27 times the PCDD/PCDF levels found in pike from the Baltic Proper (Utklippan). Pike are a major food source for sea eagles. For comparison purposes, white-tailed sea eagle eggs from **Lapland**, which is a background area receiving PCDD/PCDF primarily via atmospheric input, contain lower PCDD/PCDF concentrations, 210 pg **TEQ/g** lw. This is 5-6 times as much PCDD/PCDF as in the pike they eat. Planar PCB concentrations were 1100 pg **TEQ/g** lw in the **Lapland** eagle eggs.

Figure 50. Concentrations of PCDD/PCDF in different Baltic organisms.

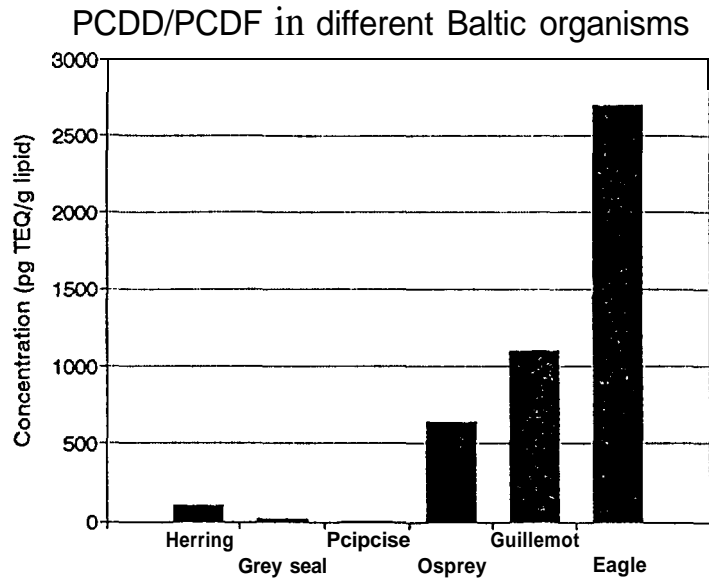
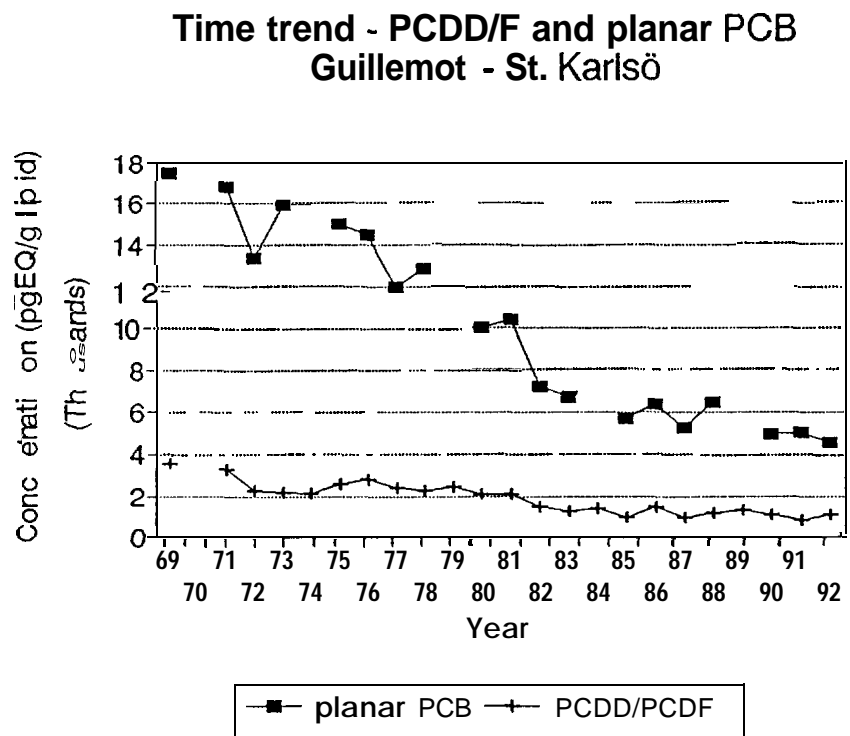

Figure 51. Time trend in concentrations - PCDD/F and planar PCB in guillemot - St. Karlsö.



The PCDD/PCDF concentration in osprey breast muscle was **640 pg TEQ/g lw**. The planar **PCB TEQ** was **4600 pg/g lw**. Thus, piscivorous birds seem to be at more risk than seals for risks related to high concentrations of **PCDD/PCDF** and planar **PCB**.

PCDD/PCDF and planar PCB were analyzed in homogenates of guillemot eggs collected from St. **Karlsö** in the Baltic Proper from 1969 to 1992 (Figure 5 1). The concentrations have decreased during this time period. In 1969, the **PCDD/PCDF** concentration was **3600 pg TEQ/g lw** and the planar PCB concentration was **17 500 pg TEQ/g lw**. In 1992, these levels have dropped to **1100 pg TEQ/g lw** for **PCDD/PCDF** and **4600 pg TEQ/g lw** for planar PCB. This may indicate that actions taken in Baltic Sea states in the 1970s such as banning PCB, pentachlorophenol and 2,4,5-T have led to reduced inputs of **PCDD/PCDF** to the environment.

4.2.3.3. Halogenated compounds in coastal sediments

In Swedish coastal areas several studies have been carried out concerning **halogenated** compounds in sediments. Most of the studies were performed within local recipient control programmes and have never been internationally published. There are, however, a few studies published concerning both sum parameters and specific compounds.

Unfortunately no long-term trend monitoring has been performed in coastal water samples as has been performed concerning concentrations in biota. The studies referred to below have been designed to fulfil other goals than to estimate **longterm** changes in the environment. Large differences are often obvious when it comes to sampling and analytical procedures, which to a certain extent prohibits comparisons between different investigations. However, there are some interesting results which are referred to below.

Reutergårdh (1988) analyzed concentrations of **PCBs** in some thirty surficial (0-2 cm) sediment samples from the coastal areas of the Baltic Proper. He concludes on the basis of concentrations related to dry matter that high sediment concentrations coincide well with anthropogenic sources like major population areas, but also close to cities with shipyards and shipping. **Perttila and Haahti** (1986) analyzed five cores from offshore areas in the Baltic Sea and found concentrations in the **surficial** sediments ranging from **4-60 ng/g dry weight**, which is about three orders of magnitude lower concentrations than what **Reutergårdh** (1988) found. Recent data from **Broman et al. (1993)**, if recalculated to dry weight basis, are in fair agreement with **Perttila and Haahti** (1986). This implies that **Reutergårdh's** data should be expressed as **µg/g** instead of **mg/g**.

Xie et al. (1986) analyzed chloroform and some chlorophenolics in sea water and chlorophenolics in sediments off the Norrsundet pulp mill in the south-western Bothnian Sea. The sediment concentrations of the different chlorophenolic substances normally vary between **1-300 ng/g dry weight**, with the highest concentrations close to the mill.

The usefulness of the sum parameter EOC1 to describe the influence areas of discharges from pulp mills has frequently been disputed in different contexts. Like most sum parameters it includes a large number of different species of substances, which may hamper its use when it comes to detecting specific discharge sources. However, EOC1 gradient studies including specific substances like chloroguaiacols, **PCDD/Fs**, alkyl-CDFs (**Jonsson et al., 1993**) and mercury (**Jonsson, 1992**), have revealed high correlations to substances undoubtedly released

from the mills. A mass balance study for the entire Baltic Sea (Wulff et al., 1993) also identifies the pulp mills as being the outstanding sources of the input of EOC1 to the Baltic Sea ecosystem. Taking these results into account, EOC1 in surficial sediments can be used as a tracer of pulp mill discharges not only locally but also on a large-scale basis.

Since the first results were published (Håkanson et al., 1988) totally 232 surficial sediment samples from accumulation bottoms have been analyzed for EOC1 in the Baltic Sea area (Jonsson, 1992). In Figure 52 these data have been compiled revealing an overall distribution pattern with high concentrations close to the pulp mills in the Bothnian Sea. Due to the scale selection, the offshore concentrations seem to be the same in the entire Baltic. However, scaling up the concentrations in the Åland Sea and the Baltic Proper, a distribution pattern appears with clearly decreasing concentrations southwards (Figure 53).

Figure 52. Extractable organic chlorine (EOC1; $\mu\text{g/g LOI}$) in surficial (0-1 cm) sediments from the Baltic Sea, Kattegat and Skagerrak. (The highest value is $6270 \mu\text{g/g LOI}$) (Data obtained from Jonsson, 1992, Anon., 1992, Jonsson & Blomqvist, 1992, Anon., 1989) (From Jonsson, 1992).

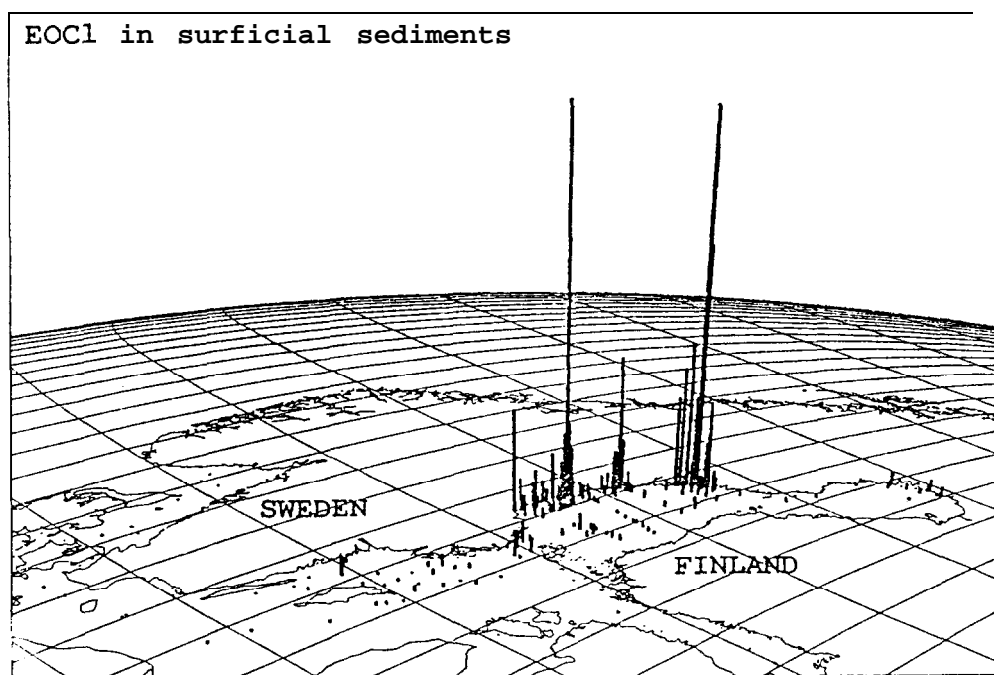

A recent estimate of EOC1 in Swedish coastal waters indicates a mean background level of $8 \mu\text{g/g loss on ignition (LOI)}$ (Jonsson et al., 1993). The average concentrations in the different parts of the Baltic and the Skagerrak/Kattegat area (Figure 54) clearly identify the Bothnian Sea as the most contaminated area. It is also evident that the coastal zones in the Bothnian Sea are highly polluted with concentrations in the surficial sediments over large areas, exceeding the background level by > 30 times.

Jonsson et al. (1993) investigated EOC1, chloroguaiacols, polychlorinated dibenzodioxins and -furans (PCDD/Fs) and alkylated dibenzofurans (alkyl-CDFs) in surficial sediments from the Iggesund pulp mill towards the open sea. Although the number of sampling sites is small

(n =6), the results strongly indicate that the mill is the source of a number of PCDD/F congeners (2,3,7,8-TCDD, 2,3,7,8-TCDF, 1,2,7,8-TCDF, 1,2,3,7,8-PnCDD), alkyl-CDFs, 3,4,5-TCG and TeCG (Figure 55). High correlations have been obtained between EOC1 and these substances, supporting the conclusion that EOC1 is a useful parameter for tracing pulp mill discharges in surficial sediments.

Figure 53. Extractable organic chlorine (EOC1; $\mu\text{g/g LOI}$) in surficial (0-1 cm) sediments from Åland Sea, Baltic Proper, Kattegat and Skagerrak. (1 unit of scale = 50 $\mu\text{g/g LOI}$) (from Jonsson 1992).

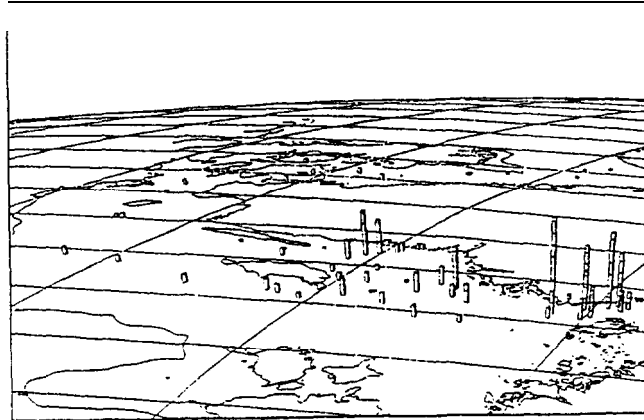

Figure 54. Mean concentrations and range for extractable organic chlorine (EOC1; $\mu\text{g/g LOI}$) in surficial (0-1 cm) sediment from different areas (near areas < 10 km from pulp mill excluded) (from Jonsson 1992).

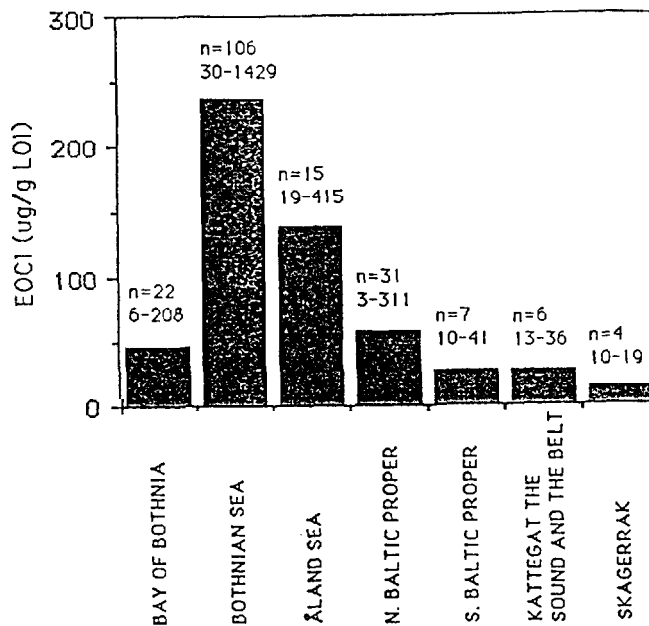
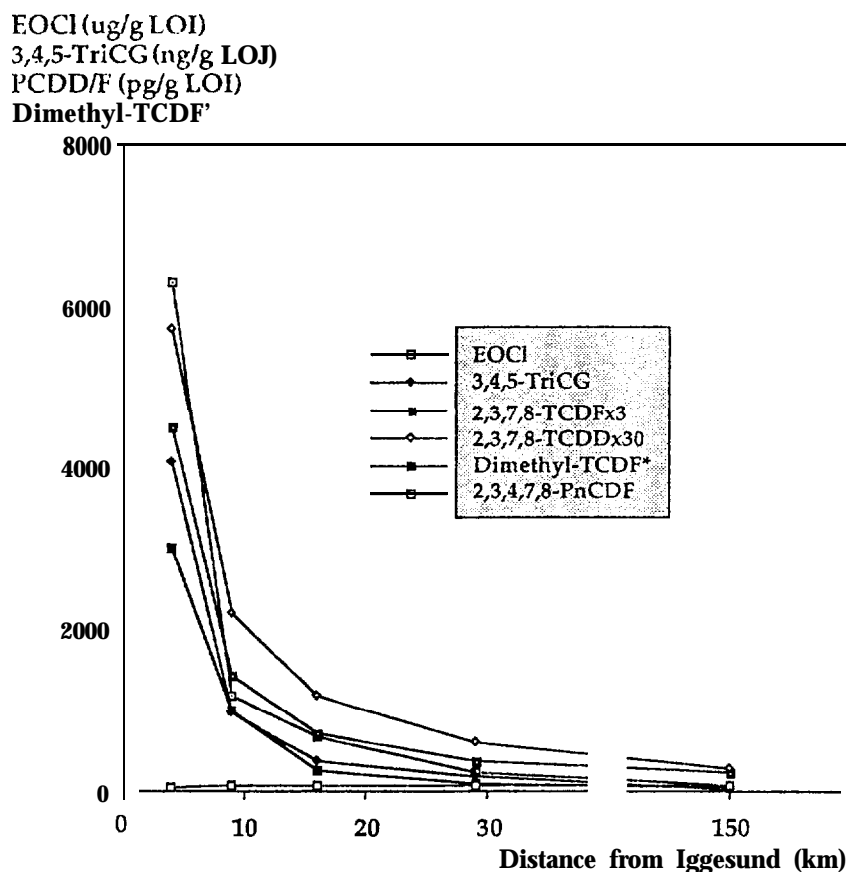

Figure 55. Extractable organic chlorine (EOC1), 3,4,5-trichloroguaiacol (3,4,5,-TCG), some PCDD/Fs and dimethyl-TCDF in surficial sediment along a gradient from Iggesund to the central part of the Bothnian Sea. The curve for dimethyl-TCDF is relative to the highest value and has been drawn assuming that the highest value is 100% (from Jonsson et al., 1993).



Among the PCDD/Fs, a characteristic **isomeric** pattern appears in the Iggesund area. This pattern, which is quite different from the typical background pattern, is dominated by the two isomers 2,3,7,8- and 1,2,7,8-TCDF. This dominance gradually decreases with distance from the mill. In the middle of the Bothnian Sea the background pattern dominates.

Close to the mill, two series of peaks, with concentrations three orders of magnitude higher than the PCDD/Fs, have been identified as alkyl-CDFs (methyl and dimethyls). So far, the only known source of these substances is pulp mill discharges, and thus the identification of alkyl-CDFs in the central parts of the Bothnian Sea and the northern Baltic Proper also indicates a large-scale distribution of pulp mill discharges in the Baltic Sea.

The appearance of 3,4,5-TCG in the central parts of the Baltic, which so far, only has been related to pulp mills, also indicates the large-scale influence of pulp mills. Figure 55 shows that 3,4,5-TCG is highly correlated to EOC1 in the Iggesund archipelago. Only a limited number of analyzes have been performed on sediment samples from the open sea. However, when compiling these offshore data with the Iggesund data (Figure 56 a, b), a high correlation is obtained between EOC1 and 3,4,5-TCG, even if the high values from coastal areas are excluded.

Figure 56. The relationship between EOC1 and 3,4,5-TCG in a) the Iggesund area and offshore sediments from the Bothnian Sea b) offshore sediments from the Bothnian Sea (from Jonsson et al., 1993).

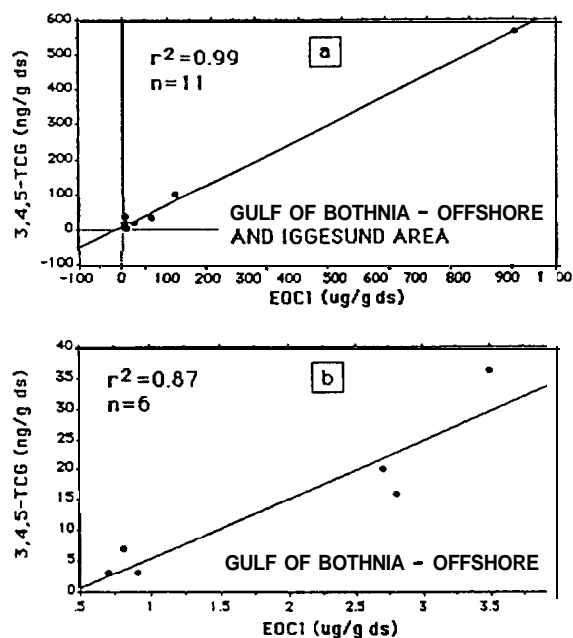

Wulff et al. (1993) calculated a mass balance of EOC1 for the Baltic Sea based on direct measurements and historical emission data from the pulp mills. Some of the results are interesting, since information can be obtained concerning the trapping efficiency for EOC1 in the coastal zone. The measurements were carried out during 1988 and 1989 in river runoff, precipitation, sea water and sediments to estimate the input/output and to calculate the stores in water and sediments. The discharges from pulp mills clearly dominate the input (75 %), while the input via rivers is negligible (< 2 %). The atmospheric input has been calculated to be 23 % of the total (Figure 57). More than 50 % of the input since the early 1940s is still stored in the Baltic system, although a substantial part must have left the Baltic Sea through the Danish Sounds. The main part (80 %) of the store is found in the sediments and the rest in the water mass.

Since the main input goes into the Bothnian Sea, where the coastal sediments show remarkably high concentrations (cf. Figure 52), one might expect to find most of the EOC1 stored in the coastal sediments. However, estimates yield that, despite the high concentrations close to the mills, these coastal sediments contain only some 10 % percent of the total sediment store. About 90 % is dispersed from the discharges into the open sea areas, and the main part (ca. 60 %) of the sediment store is found in the sediments of the Baltic Proper, indicating a large-scale transport of EOC1 from the Gulf of Bothnia to the Baltic Proper. Independent checks of the annual input of EOC1 to the sediments from the large material of EOC1 in surficial sediments are in agreement with these results. One important conclusion from the mass balance is that the Baltic Proper seems to act more efficiently than the Bothnian Sea in trapping EOC1 in the sediments.

Another important conclusion to be drawn from the mass balance study is that a major part of the total input of EOC1 since the 1940s is still stored in the Baltic sediments indicating a substantial persistence to degradation. A two-year incubation study of **EOC1-contaminated** sediments (Granmo et al., 1992; Wulff et al., 1993) in various environments (aerobic, anaerobic, sediment suspension, flow-through and closed systems, different temperature) indicates a degradation half-time of EOC1 in decades rather than months/years, supporting the results of the mass balance study.

In a sediment core from the Bomholm Deep (Nylund et al., 1992), polybrominated diphenyl ethers (**PBDE**) show a more rapid increase towards the sediment surface than for **sPCB** and **sDDT**. This may be an indication of a recent substantially increased use of PBDE as flame retardants, but may also be an indication of different degradation rates and/or water solubility. Thus, conclusions from retrospective sediment studies of halogenated compounds must be drawn with great care. So far no analyzes of PBDE in coastal Baltic waters have been made, but should be urged.

There are strong indications that the status of the Baltic Proper during recent decades has altered towards more eutrophic conditions. From results obtained in lake studies of factors controlling biological uptake of chlorinates (e.g. Larsson et al., 1992) as well as metals (e.g., **Håkanson**, 1984; **Håkanson** et al., 1988b), one may assume that increased eutrophication of the Baltic Sea may lead to a substantial scavenging of contaminants from the water mass down to the sediments, subsequently leading to lower concentrations of contaminants in pelagic biota.

Figure 57. A Budget of EOC1 for the three sub-basins of the Baltic Sea based on data for 1988-1989. Input data are given in tons/yr and the stores in sediment and water mass in tons (From Wulff et al., 1993).

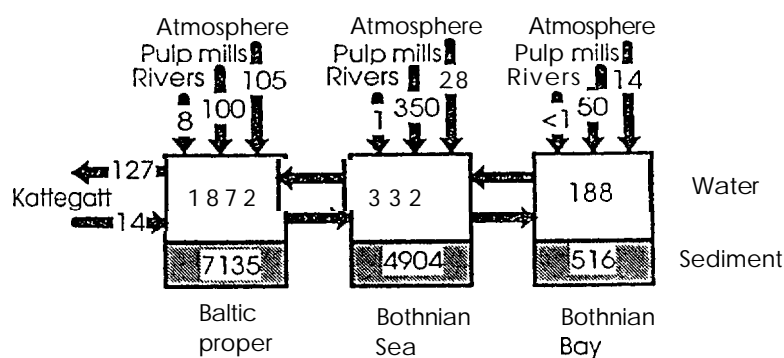

During recent decades, Jonsson (1992) registered substantially increased sequestering of many contaminants in the offshore Baltic Proper sediments, which may be indications of eutrophication-induced recent redistribution of contaminants within the Baltic ecosystem. Substantial parts of the contaminants are presently buried and to a certain extent “pacified” in the laminated offshore sediments of the Baltic Proper. At present, we do not know if similar increased sequestering occurs also in sheltered areas of the coastal zone.

REFERENCES

- Andrae, O. & P.N. Froelich, 1989. Arsenic, antimony and germanium biochemistry in the Baltic Sea. - *Tellus*, 36 B.
- Andrulewicz, E., 1992. Harmful substances. In: Marine pollution. An assessment of the effects of pollution in the Polish coastal area of the Baltic Sea. - *Studia i Materialy Oceanologiczne*, Nr 61, 131-148.
- Anon., 1989. Organiske halogenforbindelser i det marine miljø. - Statusnotat fase 1 og 2. Water Quality Institute No. 400083 (Hørsholm Denmark). Mimeo (in Scandinavian).
- Anon., 1989. Miljöanalys Vastemorrlands län. - Länstyrelsen i Västernorrlands län 1989: 1, ISSN 0280-1 140, 112 pp (in Swedish).
- Anon., 1993. Metallema och miljön. - SNV Rapport no 4135, 203 pp.
- Anon. Undersøgelser i Lillebelt 1985-87. Samlerapport, Lillebeltsamarbejdet, Fyn, Veile og Sønderjyllands Amter, p 75-81.
- Bengtsson, Å. & V. Miettinen, 1986. Spinal deformities and concentrations of heavy metals and chlorophenols in the fourhorn sculpin (*Myoxocephalus quadricornis* L.) off the Finnish coast of the Bothnian Bay. - *Publ. Water Res. Inst.*, 68, 175-178.
- Bergek, S., Bergqvist, P-A., Hjelt, M., Olsson, M., Rappe, C., Roos, A. & Zook, D., 1992. Concentrations of PCDDs and PCDFs in seals from Swedish waters. - *Ambio*, Vol. 21, No. 8, 553-556.
- Bergfors, S., 1993. Kemisk undersökning av Östersjömusslor. Rapport till Högskolan, Kalmar, lp. (in Swedish).
- Bignert, A., Olsson, M., Bergqvist, P-A., Bergek, S., Rappe, C., de Wit, C. & B. Jansson, 1989. Polychlorinated dibenzo-p-dioxins (PCDD) and dibenzo-furans (PCDF) in seal blubber. - *Chemosphere*, Vol. 19, Nos 1-6, 551-556.
- Bignert, A., Jönsson, M., Olsson, M. & W. Persson, 1992. Concentrations of contaminants in biological tissues over time. Report, Swed. *Contam. Monitor. Progr.*, 14 pp (mimeogr.)
- Bignert, A., Göthberg, A., Jensen, S., Litzén, K., Odsjö, T., Olsson, M. & L. Reutergårdh, 1993. The need for adequate biological sampling in ecotoxicological investigations: a retrospective study of twenty years pollution monitoring. - *The Science of the Tot. Envir.*, 128, 121-139.
- Björklund, J., 1985. Regional kartering av metallinnehållet i mjukdelar hos Lymnea utmed Bottenvikskusten 1980-82. - SNV Rapport 3047. (in Swedish).
- Blomkvist, G., Roos, A., Jensen, Bignert, A. & M. Olsson, 1992. Concentrations of sDDT and PCB in seals from Swedish and Scottish waters. - *Ambio*, 21:8, 539-545.
- Blomkvist, G., Jensen, S. & M. Olsson, 1993. Concentrations of organochlorines in perch (*Perca fluviatilis*) sampled in coastal areas of the Baltic Republics. - Report, Swedish. Museum of Natural History, 10.09.93, 1-11 pp (mimeogr.).
- Borg, H. & P. Jonsson, 1992. Large-scale metal distribution in Baltic sediments. - In: P. Jonsson, *Doct. Dis. Upps. Univ.*, 1992, 33 pp.
- Borg, H., Grimås, U., Göthberg, A., Lindqvist, L., Lithner, G., Neumann, G. & H. Wrådhe, 1991. Metaller i svenska havsområden. - Naturvårdsverkets Rapport no 3696, 86 pp. (in Swedish).
- Brzezinska, A., Trzosinska, A., Zmijewska, W. & L. Wodkiewicz, 1984. Trace metals in some organisms from the southern Baltic. - *Oceanologia*, 18, 79-94.
- Broman, D., Colmsjö, A., Ganning, B., Näf, C., Zebühr, Y. & C. Östman, 1987a. "Fingerprinting" petroleum hydrocarbons in bottom sediment, plankton, and sediment trap collected seston. - *Mar. Poll. Bull.*, 18:7, 380-388.

- Broman, D., Lindqvist, L., & I. Lundberg, 1987. Kadmium och zink i blåmussla (*Mytilus edulis*.)- SNV Rapport 3548 (in Swedish, summary in English).
- Broman, D., Colmsjö, A., Ganning, B., Näf, C. & Y. Zebühr, 1988. A multi-trap study on the temporal and spatial variability of polycyclic aromatic hydrocarbons and lead in an anthropogenically influenced archipelago. - Environ. Sci. Technol., Vol. 22, no 10, 1219-1228.
- Broman, D., Näf, C., Zebür, Y., Bandh, Y., Ishaq, R., & H. Pettersen, 1993. Occurrence, distribution and turnover of some toxic substances in the water mass and sediments in the Baltic Sea. - Baltnews 4:g, 10.
- Brtigmann, L., 1978. Zum Vorkommen von polychlorierten Biphenylen und DDT-Metaboliten im Plankton und Wasser der Ostsee. - Fischerei-Forschung, Wissenssch. Schriftenreihe 16:2, 31-37. (in German).
- Brtigmann, L. & U. Hennings, 1984. Trace metal budgets and fluxes for the Baltic Sea. - Proc. XIV Conf. Baltic Oceanogr., Gdynia, 1984.
- Brügmann, L. & A. Bachor, 1990. Present state of the Baltic coastal waters off Mecklenburg-Vorpommern, Germany. - GeoJournal 22, 185-194.
- Dahlman, O., Mörck, R., Johansson, L. & F. de Sousa, 1992. Chemical composition of modern bleached kraft mill effluents. - In: Swed. Environ. Prot. Agency, Rep. 4031, 47-56.
- de Wit, C., Jansson, B., Bergek, S., Hjelt, M., Rappe, C., Olsson, M. & Ö. Andersson, 1992. Polychlorinated dibenzo-p-dioxin and polychlorinated dibenzofuran levels and patterns in fish and fish-eating wildlife in the Baltic Sea. - Chemosphere, Vol. 25, Nos 1-2, 185-188.
- Duinker, J.C., 1992. Polychlorierte Biphenyle (PCB) im Wasser, Sediment und Organismen der Kieler Bucht. - Bericht an das Landesamt für Wasserhaushalt und Küsten Schleswig-Holstein, O-27 + Tabellen und Figuren. (Manuscript) (in German).
- Edgren, M., 1978. Tungmetaller i Mälarens och Östersjöns sediment. - SNV PM 1018. 110 pp. (in Swedish).
- Edgren, M., Olsson, M. & L. Reutergårdh, 1981. A one year study of the seasonal variations of sDDT and PCB levels in fish from heated and unheated areas near a nuclear power plant. - Chemosphere, Vol. 10, No. 5, 447-452.
- Elliott, M. & A.H. Griffiths, 1986. Mercury contamination in components of an estuarine ecosystem. - Wat. Sci. Tech., 18: 161-170.
- Elmgren, R., Hansson, S., Larsson, U., Sundelin, B. & P.D. Boehm, 1983. The "Tsesis" oil spill: acute and long-term impact on the benthos. - Mar. Biol., 73, 51-65.
- Elmgren, R., 1985. Oljan som miljöhot. In: Fisk eller olja ur havet. - FRN Källa/20, 34-44. (in Swedish).
- Essink, K., 1985. Monitoring mercury pollution in Dutch coastal waters by means of the teleostean fish *Zoarces viviparus*. - Netherl. Journ. of Sea Res., 19 (2): 177-182.
- Falandysz, J., 1984. Trace metals and organochlorines in plankton of the Baltic Sea. - Mar. Poll. Bull., V:15, No 11, 416-418.
- Forsberg, A., Söderlund, S., Frank, A., Petersson, L.R. & M Pedersén, 1988. - Environ. Poll, 49, 245-263.
- Frank, A., Galgan, V., Roos, A., Olsson, M., Petersson L.R. & A. Bignert, 1992. Metal concentration in seals from Swedish waters. - Ambio, 21:8, 529-538.
- Förlin, L., Andersson, T., Balk, L. & Å. Larsson, 1992. Biochemical and physiological effects of pulp mill effluents on fish. - In Swed. Environ. Prot. Agency, Rep. 4031, 235-243.
- Haraguchi, K., Athanasiadou, M., Bergman, A., Hovander, L. & S. Jensen, 1992. PCB and PCB methyl sulfones in selected groups of seal from Swedish waters. - Ambio, 21:8, 546-549.

- Grahn, O., 1989. Fiskeribiologiska undersökningar i Gävlebukten 1988. - Rapport MiljöForskarGruppen 1989-05-22, 1-7. (in Swedish).
- Granmo, A., Jonsson, P., Brydsten, L., Ekelund, R., Magnusson, K. & M. Berggren, 1992. Long-term degradation tests with coastal Baltic Sea sediments contaminated by extractable organic halogens. - In: **Södergren, A.** (Ed), SNV Report, 4031, 68-73.
- Grimås, U.**, 1961. The bottom fauna of natural and impounded lakes in northern Sweden. - Inst. Fresw. Res., Drottningholm, 42, 183-237.
- Grimås, U.**, 1987. Quality status of the Skagerrak. - **Naturvårdsverket**, Rapport 3294, 67 pp.
- Grimås, U., Göthberg, A., Notter, M., Olsson, M. & L. Reutergårdh**, 1985. Fat amount - a factor to consider in monitoring studies of heavy metals in cod liver. - *Ambio*, Vol. 14, no 3, 175-178.
- Grimås, U., Dahlgård, H. & A. Aarkrog**, 1986. Behaviour of marine pollutants studied by radioecological methods. - **Statens Naturv.** (SNV) Report 3093, 45 pp.
- Grimås, U. & J.M. Suárez**, 1989. **Metaller** efter Östersjökusten. - **Naturvårdsverket**, Rapport 3580, 79 pp. (in Swedish).
- Grimås, U. & A. Jacobsson**, 1991. Reproduktion, yngelöverlevnad och metaller hos tånglake. - SNV, Rapport 3920, 7 pp. (in Swedish).
- Gustavsson, I., 1983. The concentrations of cadmium, lead and copper in filtrated Baltic Sea water samples collected at two seasons in 1979. - *Acta Hydroch. et Hydrobiol.*, 11:3, 309-317.
- Hanberg, A., Ståhlberg, M., Georgellis, A., de Wit, C. & U. G. Ahlberg**, 1991. Swedish dioxin survey: evaluation of the H-4-11 E bioassay for screening environmental samples for dioxin-like enzyme induction. - *Pharmac. & Toxic.* 69, 442-449.
- Hesse, J.M., Janus, J.A., Krajnc, E.I. & E.D. Kroese, 1990. Integrated criteria document, arsenicum. Appendix; Effects. - *Nat. Inst. Publ. Health Environm. Prot.*, Report no. 710401004.
- Hirvi, J-P., 1989. Oil pollution problem in the Baltic marine environment. - Proceedings, 12th Arctic and Marine Oil Spill Programme Technical Seminar, June 1989, Calgary, Alberta.
- Holz, R. & W. Starke, 1990. Fremdstoffbelastung in Eiern mecklenburgischer Lachmöwen (*Lams ridibundis*) von 1975 bis 1986. - *Arch. Nat.schutz.Landsch.forsch.*, Berlin, 30, 177-194.
- Hyvärinen, H. & T. Valtonen**, 1973. Seasonal changes in the liver mineral content of *Coregonus nasus* (Pallas), *sensu Svardson*, in the Bay of Bothnia. - *Comp. Bioch. Physiol.*, Vol. 45B, 875-881.
- Håkanson, L., Jonsson, P., Jonsson, B. & K. Martinsen**, 1988a. Distribution of chlorinated organic substances from pulp mills. - *Wat. Sci. Techn.*, Vol. 20, No. 1, 25-36.
- Håkanson, L., Nilsson, T. & T. Andersson**, 1988b. Mercury in fish in Swedish lakes. *Environm. Poll.*, 49, 145-162.
- Häkkilä, K.**, 1980. Heavy metals in sediments and bottom fauna in the sea area off **Pori** on the west coast of Finland. - *Nat. Board of Waters, Rep. no 190*, 39 pp. (in Finnish, English summary).
- ICES, 1977. Studies of the pollution of the Baltic Sea.- *Coop. Res. Rep.*, 63: 97 pp.
- Jacobsson, A., Neuman, E. & M. Olsson, 1993. The viviparous blenny as an indicator of effects of toxic substances. - *Fiskeriverket, Kustrapport 1993:6*, 1-22.
- Jankovski, H. & M. Simm, 1984. Content of heavy metals and chlororganic compounds in the plankton of the Baltic Sea. - *Hydrobiological Regime of the Baltic Sea, Tallinn*, 120-127. (in Russian).
- Jankovski, H., Kukk, H. & Y. Volozh, 1988. Accumulation of heavy metals in the Baltic Sea algae. - *Proc. Acad. Sciences, Est. SSR, Biology*, 37, 3, 233-241.

- Janus, J.A. Canton, J.H., van Gestel, C.A.M. & E. Heijna-Merkus., 1989. Integrated criteria document, copper. Appendix, Effects. - Nat. Inst. Publ. Health Environm. Prot., Report no 758474009.
- Jensen, S., Johnels, A.G., Olsson, M. & G Otterlind, 1969. DDT and PCB in marine animals from Swedish waters. - Nature, Vol. 224, No. 5216, 247-250.
- Jensen, S., Johnels, A.G., Olsson, M. & G. Otterlind, 1972. DDT and PCB in herring and cod from the Baltic, the Kattegat and the **Skagerrak**. - Ambio Special Report, No. 1, 71-85.
- Jensen, S., Olsson, M. & R. Vaz, 1977. Levels of DDT and PCB in littoral fishes along the Swedish coast. - Ambio, Special Report, No 5, 75-80.
- Jonsson, P., 1992. Large-scale changes of contaminants in Baltic Sea sediments during the twentieth century. Doctoral thesis at Uppsala University, 227 pp.
- Jonsson, S., **Borén**, H., Grimvall, A. & R. **Sävenhed**, 1992. Analysis of adsorbable organic halogens (**AOX**) and chlorophenols present in the water of the Baltic Sea. - In: Swed. Environ. Prot. Agency, Rep. 4031, 95-100.
- Jonsson, P., Rappe, C., Kjeller, L.-O., Kierkegaard, A., **Håkanson**, L. & B. Jonsson, 1993. Pulp-mill related polychlorinated organic compounds in Baltic Sea sediments. - Ambio 22, 37-43.
- Kangas, P. & H. Autio, 1986. Macroalgae as indicators of heavy metal pollution. - Publ. Water Res. Inst., **68**, 183-189.
- Kineman, J.J., Elmgren, R. & S. Hansson (Eds). The Thesis oil spill. Report of the first year scientific study. - Dep. of Commerce, NOAA/OCSEP, 296 pp.
- Korolev, A., Kuznetsova, T. & V. Drozdetsky, **1993B**. Investigations of the *Furcellaria lumbriicalis* distribution and abundance at the eastern coast of the Baltic Sea. - ICES, C.M. 1993/L 39, 16 pp.
- Kremling, K., **Brügmann**, L. & A. Jensen, 1987. Trace metals (TM) in the Baltic. - Balt. Sea Environ. **Proc.**, **17B**, 82-130.
- Kukk, H., Heinlaid, H., Talvari, A. & H. Jankovski, 1990. Accumulation of chlororganic compounds and petroleum hydrocarbons in the Baltic Sea algae. - Eksperimentalnaja Vodnaja toksikologija. - Riga, Zinante, **Fac. 14**, pp 27-34. (in Russian, summary in English).
- Larsson, Å., Haux, C. & M-L. **Sjöbeck**, 1985. Fish physiology and metal pollution: Results and experiences from laboratory and field studies. - Ecotoxicol. Environ. Safety 9, 250-281.
- Larsson, Å., Haux, C. & M-L. **Sjöbeck**, 1986. Toxiska effekter av **metaller på fisk**. - **Naturvårdsverket** Rapport 3166, 68 pp. (in Swedish).
- Larsson, P., Collvin, L., Okla, L. & G. Meyer, 1992. Lake productivity and water chemistry as governors of the uptake of persistent pollutants in fish. - Envir. Sci. **Techn.** (in press).
- Lehtinen, K-J., Notini, M., Mattsson, J. & L. Landner, 1988. Disappearance of bladder-wrack (*Fucus vesiculosus* L.) in the Baltic Sea: Relation to pulp-mill chlorate. - Ambio, **17 (6)**, 387-393.
- Lindesjö, E., 1992. Epidemiological studies of fish in bleached pulp mill effluents. - in: Swedish. Envir. Prot. Agency, Report 4031, 314-328.
- Lindesjö, E. & J. Thulin, 1990. Fin erosion of perch *Perca fluviatilis* and ruffe *Gymnocephalus cernua* in a pulp mill effluent area. - Dis. Aquat. Org., **8**: 119-126.
- Lindeström, L., Grahn, O. & C. Monfelt, 1989. Fisken i Gävlebukten - påverkan av metaller från Dalälven. - MiljöForskarGruppen, F9/006:3, 1-26. (in Swedish).
- Lindström, R., 1986. Deformation of *Mytilus edulis* L. shells as index of water quality. - Publ. Water Res. Inst., **68**, 194-196.

- Lithner, G., Borg, H., Grimås, U., Göthberg, A., Neumann, G. & H. Wrådhe, 1990. Metals. In: Current status of the Baltic Sea. - *Ambio*, 7, 7-9.
- Lithner, G., Holm, K., Larsson, M.-B. & K. Holmgren, 1991. **Metaller** i djurplankton och arsenik i havsvatten i **Östersjöområdet** 1975-1987. - **Naturvårdsverket** Rapport 3895, 32 pp. (in Swedish).
- Lithner, G., Broman, D., Borg, H., Johansson A.-M., **Kärrhage, P.** & M.-B. Larsson, 1993. Metals in sedimenting material and surface sediment at selected places along the east coast of Sweden. - *Mar. Poll. Bull* (submitted), 31 pp.
- Litvinenko, L.L., Krasnov, E.V. & B.V. Karasjov, 1990. Environment monitoring in the Kaliningrad region. - Paper given at USSR/Swedish seminar, Stockholm April 1990, 1-11. (mimeogr.).
- Miettinen, V. & M.-L. Hattula, 1978. Chlorinated hydrocarbons and mercury in zooplankton near the coast of Finland. - *Publ. Water Res. Inst.*, No 30, 46-50.
- Morin, R., 1991. Kvicksilverhalt i **abborre** i Sundsvallsbukten sommaren 1991. - Report to SCA, **Wifsta-Östrand**, No 03.53, 1-5. (in Swedish).
- Møller, B.**, 1982. **Fornæs** 1981. Sediment, bundfauna, spormetaller i fisk. - Vandkvalitetsinstituttet, ATV, Saknr: 81.595, 146 pp. (in Danish).
- Neuman, E. & P. Karås, 1988. Effects of pulp mill effluent on a Baltic coastal fish community. - *Wat. Sci. Tech.*, Vol. 20, No 2, 95-106.
- Neuman, E., **Sandström, O.** & M. Olsson, 1988. Some aspects of the influence of pollution on the quantity and quality of the Baltic Sea fishery resources. - *ICES BAL/No 28*, 1-8.
- Nylund, K., **Asplund, L.**, Jansson, B., Jonsson, P., **Litzén, K.** & U. **Sellström**, 1992. Analysis of some polyhalogenated organic pollutants in sediment and sewage sludge. - *Chemosph.* 24, 1721-1730.
- Odsjö, T.** & Olsson, M., 1989. Övervakning av miljögifter i levande organismer. Rapport från verksamheten 1988. - **Naturvårdsverket** Rapport 3664 (in Swedish).
- Olsson, M., 1987. PCB in the Baltic environment. In: PCB and the environment, Vol. III, 181-208. (Editor **J.S.Waid**) CRC Press, Boca Raton, Florida.
- Olsson, M., Jensen, S. & L. Rehnberg, 1972. PCB in coastal areas of the Baltic. - In: PCB Conference II, National Swedish Environmental Protection Board, Public. 1973:4E, 59-68.
- Olsson, M. & S. Jensen, 1975. Pike as test organism for mercury, DDT and PCB pollution. A study of the contamination in the Stockholm archipelago. - *Rep. Inst. Freshw. Res., Drottningh.*, 54, 34-57.
- Olsson, M., Jensen, S. & L. **Reutergårdh**, 1978. Seasonal variation of PCB levels in fish - an important factor in planning aquatic monitoring programs. - *Ambio* 7, 66.
- Olsson, M. & L. **Reutergårdh**, 1986. DDT and PCB pollution trends in the Swedish aquatic environment. - *Ambio*, Vol. 15, No. 2, 103-109.
- Olsson, M. & F. Sandegren, 1991. Otter survival and toxic chemicals - implication for otter conservation programmes. - In: Proceedings V. International Otter Colloquium, **Hankensbüttel** 1989, 191-197.
- Pertillä, M.** & H. Haahiti, 1986. Chlorinated hydrocarbons in the water and sediments of the seas around Finland. - *Publ. Water Res. Inst.*, No 68, 197-200.
- Perttilä, M.** & L. Briigmann, 1992. Review of contaminants in Baltic sediments. - *ICES Coop. Res. Rep.* 180, 135 pp.
- Phillips, D.J.H., 1977. The common mussel *Mytilus edulis* as an indicator of trace metals in Scandinavian waters. I. Zinc and cadmium. - *Mar. Biol.* 43, 283-291.
- Phillips, D.J.H., 1978. The common mussel *Mytilus edulis* as an indicator of trace metals in Scandinavian waters. II. Lead, iron and manganese. - *Mar. Biol.* 46, 147-156.

- Phillips, D.J.H., 1979. Trace metals in the common blue mussel, *Mytilus edulis* (L), and in the algae, *Fucus vesiculosus* (L), from the region of the Sound (Öresund). - Environ. Poll., 18, 31-43.
- Pfister, K., 1980. The 1979 Baltic oil spill. Environmental studies. - Ministry of Interior, Dep. for Env. Prot., Governm. printing centre, **A:2**, 53 pp.
- Pitkänen, H., Kangas, P., Miettinen, V. & P. Ekholm, 1987. The state of the Finnish coastal waters in 1979-1983. - Vesi- ja **Ympäristöhallinnon** Julkaisuja, 8, 167 pp.
- Pitkänen, H., Kangas, P., Miettinen V. & P. Kauppila, 1991. The state of the Finnish coastal waters in the late 1980s. - In manuscript, 37-52.
- Reutergårdh, L., 1988. Identification and distribution of chlorinated organic pollutants in the environment. - SNV, Report 3465, 74 pp.
- Roots, O., 1981. Polychlorinated biphenyls and chlororganic pesticides in molluscs of the Tallinn Bay. - In: The investigation and modelling of processes in the Baltic Sea, Part II, 137-140.
- Roots, O., 1992. Polychlorinated biphenyls and chlororganic pesticides in the ecosystem of the Baltic Sea. - Tallinn Technical University, Tallinn 1992. (in Russian. Tables and Figures in English), 181 pp.
- Roots, O. & H. Jankovski, 1980. Mercury in the southern part of the Gulf of Finland. - Finn. Mar. Res., No 247, 68-72.
- Roots, O. & E. Peikre, 1981(a). The study of Baltic Sea zooplankton pollution with PCB and chlorinated pesticides during the 10th cruise of the R/V "Aju-Dag". - Investigation and modelling of processes in the Baltic Sea, part 2, 131-137.
- Roots, O. & E. Peikre, 1981(b). Content of persistent biphenyls and pesticides in the Baltic Sea zooplankton. - Vodnie resursi, N 6, 182-186. (in Russian).
- Roots, O. & H. Kukk, 1988. Polychlorinated biphenyls and chlororganic pesticides in algae from the Baltic Sea. - Proceedings of the Academy of Sciences of the Estonian SSR, 37, 224-226.
- Roots, O. & L. Saare, 1992. Polychlorinated biphenyls and chlorinated pesticides in the Baltic Sea 1976-1991. - In manuscript.
- Rosemarin, A., Mattsson, J., Lehtinen, K-J., Notini, M. & E Nylén, 1986. Effects of pulp mill chlorate (ClO₃-) on *Fucus vesiculosus* - a summary of projects. - Ophelia, Suppl. 4, 219-224.
- Rosemarin, A., Lehtinen, K-J. & M. Notini, 1990 a. Effects of treated and untreated softwood pulp mill effluents on Baltic Sea algae and invertebrates in model ecosystems. - **NordicPulp** and Research Joun., 83-87.
- Rosemarin, A., Notini, M., Söderström, M. Jensen, S. & L. Landner, 1990 b. Fate and effects of pulp mill chlorophenolic 4,5,6-trichloroguaiacol in a model brackish water ecosystem. - The Science of the total Environm., 92, 69-89.
- Sandler, H., 1986. Heavy metals in benthic crustaceans and mysids in the Bothnian Sea. - Publ. Water Res. Inst., 68, 205210.
- Sangfors, O., 1990. Kvicksilver i Sundsvallsbukten, Historisk och nuvarande belastning, deponier och effekter. - Report "Sundsvallsbukten", Bilaga 4, **F90/043:3**, 1-25. (in Swedish).
- Schelin, P.-E., 1977. Sedimentundersökningar i havet utanför Oxelösund. - SNV PM 824. (in Swedish).
- Seisuma, Z., Kulikova, I., Vadzis, D. & M. Legzdina, 1983. Zink, lead, cadmium and mercury in water organisms of the Gulf of Riga. In: Biocenosis of different trophic levels. - Zinatne, Riga, 162-177. (in Russian, English summary).

- Slaczka, W., E. Andrulowicz & A. Trzosinska, 1987. Harmful substances; Chlorinated hydrocarbons (DDT and PCB compounds). In: First Periodic Assessment of the State of the Marine Environment of the Baltic Sea Area, 1980-1985; Background Documents. - *Balt. Sea Environ. Proc.*, **17B**, 131-169.
- Snoeijs, P., Grimås, U. & K. Åslund, 1992. Epilithic diatoms as monitoring organisms for heavy metals in the Gulf of Bothnia - a pilot study. - Intern Report to **SNV**, 10 pp.
- Snoeijs, P. & M. Notter, 1993. Benthic diatoms as monitoring organisms for radionuclides in a brackish-water coastal environment. - *J. Environ. Radioactivity*, **18**, 23-52.
- SSI (Edit. L. Moberg), 1991. The Chernobyl fallout in Sweden. - *Swed. Radiat. Prot. Inst.*, 633 pp.
- Strömberg, T., 1982. Effects of heavy metals (Zn, Hg, Cu, Pb, Ni) on the length growth of *Mytilus edulis*. - *Mar. Biol.*, **72**: 69-72.
- Sunila, I. & R. Lindström, 1985. Survival, growth and shell deformities of copper- and cadmium-exposed mussels (*Mytilus edulis L.*) in brackish water. - *Estuarine, Coastal and Shelf Science* **21**, 555-565.
- Sundelin, B., 1992. Effect monitoring in pulp mill areas using benthic macro- and meiofauna. - In: *Swed. Environ. Prot. Agency, Rep. 4031*, 371-380.
- Svanberg, O., Gaul, H., Dahlmann, G. & M. Olsson, 1990. Organic contaminants. In: Second Periodic Assessment of the Marine Environment of the Baltic Sea, 1984-1988; - Background Document. *Balt. Sea Environ. Proc.*, **35B**, 371-428.
- Szefer, P., 1986. Some metals in benthic invertebrates in Gdansk Bay. - *Mar. Poll. Bull.* **17**, N 11, 503-507.
- Södergren, A. (Ed.), 1989. Biological effects of bleached pulp mill effluents. - National Swedish Environmental Protection Board, Report 3558, 139 pp.
- Södergren, A. (Editor), 1992. Environmental fate and effects of bleached pulp mill effluents. - Proceedings of a SEPA Conference, Stockholm, November 1991. *Swed. Environ. Prot. Agency, Rep. 4031*, 394 pp.
- Södergren, A., Adolfsson-Erici, M., Bengtsson, B-E., Jonsson, P., Lagergren, S., Rahm, S. & Wulff, F., 1992. Environmental effects of bleached pulp mill effluents discharged into the Baltic sea. - In: Swedish Environmental Protection Agency, Report 4031, 199-202.
- Söderlund, S., Forsberg, A. & M. Pedersén, 1988. Concentrations of cadmium and other metals in *Fucus vesiculosus L.* and *Fontinalis dalecarlia* Br.Eur. from the northern Baltic Sea and the southern Bothnian Sea. - *Environm. poll.*, **51**, 197-212.
- Talvari, A., Heinlaid, H., Kukk, H. & H. Jankovski, 1992. Accumulation of chlororganic compounds and hydrocarbons in Baltic seaweeds. - *Proc. Estonian Acad. Sci. Ecology*, **2**, 50-55.
- Tervo, V., 1987. Concentrations of metals in fish and benthic invertebrates in the Gulf of Finland and the Gulf of Bothnia during 1982-86. *ICES, C.M.* **1987/E:20**, 1-14.
- Tervo, V., Erkomaa, K., Sandler, H., Miettinen, V., Parmanne, R. & E. Aro, 1980. Contents of metals and chlorinated hydrocarbons in fish and benthic invertebrates in the Gulf of Bothnia and in the Gulf of Finland in 1979. - *Fin. Inst. Mar. Res., Meri* **12**: 42-57.
- Trzosinska, A., Andrulowicz, E. & A. Brzezinska, 1981. Trace elements in some organisms from the southern Baltic. - In: Exchange of chemical elements in the contact zones of the marine environment. - Moscow, 83-99. (in Russian).
- Vainio, T., Nyman, C., Lax, H-G. & P. Sevalo, 1987. Petroleum hydrocarbons after oil spill in the Gulf of Bothnia. - In: *Balt. Mar. Env. Commission*, No 22, 115-131.
- Voipio, A., Erkomaa, K., Karppanen, E., Mäkinen, I. & V. Tervo, 1977. Contents of some heavy metals and organic compounds in Baltic fish and bottom fauna. - *Ympäristö ja Terveys*, **2**, 127-143. (in Finnish).

- Voloz, J., Simm, M., Jankovski, H. & I. Kotta, 1990. Cadmium, lead, copper and zink concentrations in Mesidothea entomon in the Gulf of Finland (southern coast). - **Proc. Estonian Acad. Biol.**, 39 N 2, 141-147.
- Wulff, F., Rahm, L., Jonsson, P., Brydsten, L. Ahl, T. & Å. Granmo, 1993. A mass balance model of chlorinated organic matter for the Baltic Sea. - A challenge to ecotoxicology. - *Ambio* 22, 27-31.
- Væsel, A., Dybdahl, H.-P. & Alsing-Pedersen G., 1991. Forureninger i fisk fra Oresund, 1989. - Levnedsmiddelstyrelsen, Rapport nr F 910116, 1-13. (in Danish).
- Xie, T.-M., Abrahamsson, K., Fogelqvist, E. & B. Josefsson, 1986. Distribution of chlorophenolics in a marine environment. - *Env. Sci. Techn.*, 20, 457-463.
- Zook, D., Buser, H.-R., Bergqvist, P.-A., Rappe, C. & M. Olsson, 1992. Detection of Tris (chlorophenyl) methane and Tris (4-chlorophenyl) methanol in ringed seal (*Phoca hispida*) from the Baltic Sea. - *Ambio*, 21:8, 557-560.

5. RECREATION

5.1. Fish and fishery

Introduction

Fish and fishery are of direct economic importance. This includes the recreational aspects, measured by means of the number of people employed, income through tourism, direct values of catches, etc. For these and other reasons such as the need of reliable prognoses, statistics are often used to follow up the development of reproduction, stocks and catches in the various countries.

There are many factors behind availability of fish. It is affected by the fishery itself, especially the stocks of the open sea, by increasing fishing efforts and introduction of effective fishing gear during recent decades (Thurrow, 1991). The development is also linked to a series of environmental capacities like access to spawning and nursery grounds, water quality, etc. It should also be remembered that many coastal areas have been withdrawn from common activities during the Soviet period for national security reasons. This might still contribute to lower activities compared to the potential capacity.

There are long-term series describing parallel development and response of fish to general water quality in some areas of the Convention, even if reasons and effects by individual factors or elements sometimes are difficult to discern. The two main themes - economy and ecology - nonetheless give the theme of fish and fishery the character of a chapter with an intermediate position between water quality and recreational aspects.

The approach

It is difficult to distinguish coastal catches in fishery statistics from the total commercial catches since fishery in the sea and the open coasts is based mainly on the same species. The occurrence of species that are rare in the open sea may, however, provide an indication of the share of coastal fishery in totals. The “coastal species” in Table 24 includes freshwater species and others that are mainly available close to the coast, such as seatrout, whitefish, **vendace**, eel and **eelpout**. Salmon is not included because of its big share in the off-shore fishery and this also applies to, e.g. herring, cod and flounder, even if they are often caught in the coastal zone.

A correct picture of the magnitude of the total coastal fishery is problematic, especially in countries where open shore-lines dominate and where the same species occur both in coastal and open-sea fishery. Such a figure including also herring, flounder, salmon, etc., can be given only for some countries.

It should also be mentioned that the total commercial fish catches are far bigger for most countries than those given for the Convention area because of distance fisheries, e.g. in the **North Sea**.

Table 24. The mean total catch in commercial fishery in the Convention area 1989-1990 in metric tonnes, the total catch in coastal areas, the share of coastal species in the total Baltic catch and the number of fishermen.

	total Baltic total coast		“coastal” species		number of fishermen	
	tonnes	tonnes	tonnes	percent	profession	recreat. x10 ³
Sweden	160 000	13 000	2 100	1.3	3500	2 200 *
Finland	74 000	23 000	10 000	13.0	3000	400
Russia	72 000	15 200	8400	11.7	1600	nd
Estonia	60 000		3000	5.0	3000	150
Latvia	62 000	3 200	1000	1.6	1400	nd
Lithuania	19 000		2300	12.8	630	86
Poland	110000	15 000	3700	3.4	2400	nd
Germany	75 000		4200	5.6	1 500	100
Denmark	150 000		700	0.5	7600	250

* fishing opportunities

nd no data

Comments to the Table:

For some countries figures are available on the total coastal fishery, including marine as well as freshwater species. The number of sport- or household fisheries can be estimated as the number of people engaged or as fishery opportunities. For some areas, data are lacking.

General and regional pattern

The fishery in the coastal waters of the Baltic Sea is based on both marine and freshwater species or those which regularly migrate between the sea and the river systems. Many species have their spawning and nursery grounds in the coastal zone. Normally, the quality of these reproduction areas is regulated by **abiotic** factors, of which the most important are temperature and the topographic conditions. The archipelagoes, the river mouths and the bays are of greatest importance for freshwater species and marine coastal spawners.

The species composition in the various parts of the Baltic Sea is a function of, amongst others, salinity and temperature. The proportion between marine and freshwater species varies along an axis from north to south as well as from the open waters towards land. The Danish waters, where salinity in the surface is about **15‰**, are completely dominated by marine species. For **vendace**, the most favourable conditions are found in the Bothnian Bay because of low temperatures in combination with low salinity.

Between these extremes, large archipelagos are found mainly along the Swedish and Finnish coasts, with a large supply of warm water species like perch, pike, cyprinids and eel. With the exception of the Bothnian Bay most freshwater species depend on the coast, which means that their main areas of distribution are the archipelagos, the river mouths or the so-called haffen and bodden in the southern part of the Baltic Proper. Marine species like herring and flounder are important for the fisheries in various types of coasts while cod and sprat are mainly restricted to and caught in open coastal areas. The Gulf of **Riga** differs from the above-mentioned coastal models. In spite of the character of an open coastline it functions as a highly productive and important reproduction area of significance for fishery of the various freshwater species.

*

In Sweden, the relative importance of the coastal species in the total fish catch is low. A governmental decision has been taken to encourage a higher exploitation of coastal fish stocks. An inquiry shows 2.2 million fishery opportunities, of which about 1.3 million concern the coasts. The material is divided into two groups from 2.5 and 7 days/year on the average. Estimation of the economic value of the recreational fishery has been presented in two reports from Sweden. The coastal fishery has been estimated to 450 million Swedish crowns (**SKr**) per year (SCB 1990). Other estimations including household fishery mention 660 **MSKr** per year (Silvander 1991).

*

In Finland, the total catch in the coastal zone amounts to 18 000 tonnes, of which 3 500 are so-called coastal species and 2 100 tonnes freshwater fishes. The fishing for eel is insignificant compared to, e.g. Sweden, while the whitefish is important (1 300 tonnes). The number of sport fishermen is based on an inquiry from 1988.

*

The Russian statistics, reported by Latvia for 1989, are divided into two regions; the Gulf of Finland and the Kaliningrad area. About 1/3 of the total is reported from Kaliningrad and might be referred to the Curonian Lagoon.

*

The figures for Estonia include only catches by professional fishing. Some freshwater species, as well as salmon, have decreased during recent years. Exceptions are pike-perch and certain cyprinids which might indicate eutrophication. As large parts of western Estonia were labelled as being militarily sensitive areas, and thus closed to the public until only some years ago, it can be supposed that various activities like the non-professional fishery have not yet reached their potential. The number of sport fishermen is estimated to be 0.15 million with a mean catch of 10 kg per person and year.

*

In Latvia, stocks and catches of anadromous and catadromous fish as well as fresh- and brackish-water fish species are decreasing. This development is largely an effect of overfishing. The total landings of fish caught in the Gulf of **Riga** are demonstrated in Figure 58. There are several possible causes of this decline, including effects of pollution on spawning grounds and feeding areas plus overfishing. The reported absolute amounts and percentage share of the coastal species in the totals are low. During recent years the share of warm water species like perch, ruffe and bream have increased in the southern part of the **Riga** Bay. It is difficult to estimate the size of the non-professional coastal fisheries today. It may, however, be assumed that there is room for an increasing importance of coastal fishery activities in future, comparable to the situation in Estonia.

Figure 58. Total fish catches in the Gulf of **Riga**.

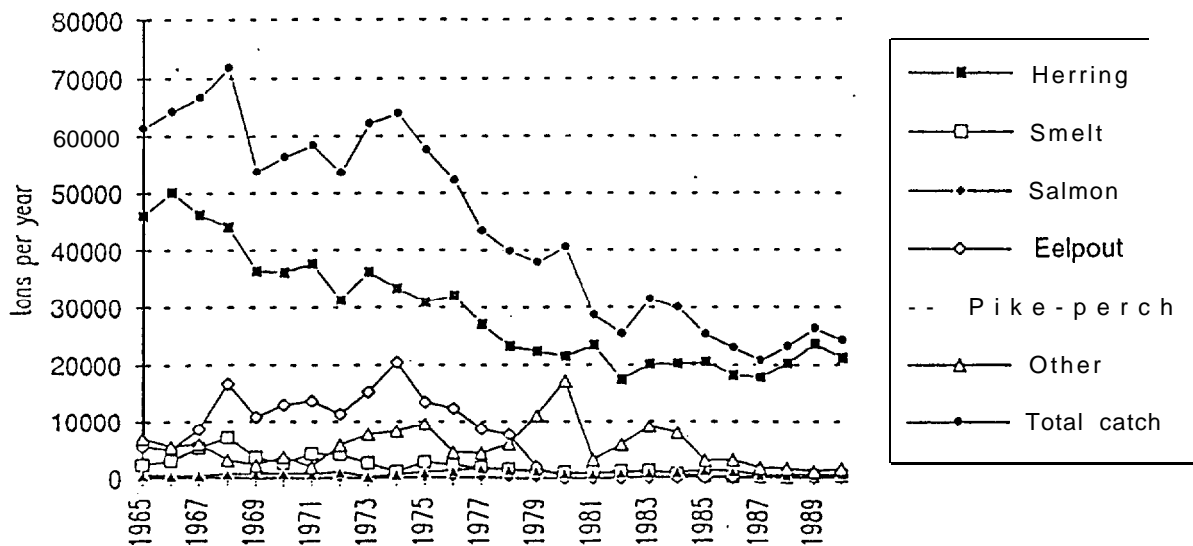

*

The Lithuanian total catch in the Curonian Lagoon, which dominates the coastal fishery, is 2 400 tonnes, of which all except eel (8 tonnes) is made up of more than 30 freshwater species identified in the fishery statistics. Cyprinids like roach and bream are dominating (60%). The delta is becoming overgrown with grass and is getting muddy, which partly prevents fish migration, feeding and spawning conditions. Vimba, which earlier was an important fish, and pike-perch and whitefish, are nowadays hardly available. Twite shad was an important species in the professional fishery some decades ago but the species has been affected by a complexity of pollutants and the last individual was caught in 1982.

*

The share of the fishery in the Lagoon in the total fishery is most important also in the Kaliningrad area. The catch in the Kaliningrad part of the Curonian Lagoon is reported to be 2 200 tonnes in 1990. As in Lithuania the catch is totally dominated by freshwater species like roach, bream and ruff (70%) and includes only 2 tonnes of eel. The fishery on whitefish, which was prohibited in 1985, was opened in the Kaliningrad area as an experiment and gave 5.5 tonnes in 1990.

*

In Poland there are about 600 small boats and about 70 medium-sized boats (< 16 m) fishing in the coastal zone. Furthermore, there are about 150 large fishing boats (> 16 m) from which 50 percent of the catch comes from coastal areas. The total coastal fishery in Poland amounts to 15 000 tonnes. The brackish-water species like herring, cod and **flatfish** are dominating and constitute 71% as an effect of the open coastline. The freshwater species make up 25 % or 3 700 tonnes. Again there is a definite change in the composition of species with an increased amount of herring, a decrease of plaice and elimination of migratory whitefish. The reasons for the observed changes are not a limitation of food resources but rather a deterioration of living conditions, such as degradation of and obstructed access to spawning grounds and pressure of predatory fish (Skora, 1992).

*

In Germany, the share of coastal species in the total catch is relatively large. Freshwater species like roach, perch, bream, pike-perch and pike are mainly caught in the semi-enclosed Bodden and Haffen even if some are taken by the trawl fishery off the coast of **Rügen** and Usedom. In Schleswig/Holstein the number of organized anglers is 34 000 and the number of registered fishery licenses is 60 000. Of these about 10% are supposed to utilize coastal areas, In the former GDR, the organisation of recreational fishermen amounted to 540 000 members. Nowadays, this number is about 70 000 in **Mecklenburg/Vorpommern** from which only a part is fishing in the coastal zone.

*

About 100 tonnes of freshwater species, mainly perch, are noted in catches from the southern Danish waters. Eel fishery is more important because of its economic value. This fishery is concentrated to the southern and eastern part of the islands, the southern part of **Jutland** and the large bays. The 700 tonnes registered in the late 1980s is half the value reported from 1982. Also the marine fish species in the coastal fisheries have decreased dramatically during the 1980s, especially in the Kattegat and the Belt Sea. Such a development is also reported from the Swedish coast of the Sound.

*

As a general concluding remark on the results presented, most stocks of freshwater species, as well as several marine species, depend on the coastal areas for spawning, nursing, feeding, etc. With reference to the economic evaluations of Swedish sport-fishery at the coastline and the experiences in, e. g. Finland, it can also be established that the coastal zone is of utmost value for recreation; a resource to be rescued from perturbances. It should also be taken into account that subsistence and part-time fishery, normally not included in the professional or non-professional fisheries but of direct economic importance in most countries, should be added to this recreational aspect.

Examples of effects

Species approach

A common message received from all countries concerns the trends over time in the availability of some fish species, which are important in the fish catches.

* The decrease as regards cod in stocks and landings is noticed in all regions and regarded mainly as a result of a downward trend in recruitment. The reason for this seems to be the increasing fishing mortality in the Kattegat and the Belt Sea. The gradually decreasing salinity and the low oxygen concentration in the bottom waters in the spawning areas of the Baltic Proper affects the availability of cod in the whole Baltic Sea.

* The same trend cannot be seen for pelagic species like herring, which fluctuates in stocks and landings and in many areas increases in relative or absolute importance, even in the coastal zone. One proposed explanation of this development, in spite of the increased fishing effort, is the eutrophication of the Baltic Sea and thereby an increased availability of food.

* A species that is more specific for the coastal zone is the eel. All countries report decreasing catches during recent decades. An example is given in Figure 59, which describes the catch of eel in the Curonian Lagoon during the last 45 years from the Lithuanian as well as the Kaliningrad area. It can be supposed that the fishery was not optimized immediately after World War II which might explain the low catches until the beginning of the 1950s. The main explanation for the gradual decline of eel during the last 25 years is the large-scale reduction of the immigration of eel elvers into the Baltic.

Figure 59. Curonian Lagoon. The catch of eel in the Lithuanian and Kaliningrad areas of the Lagoon for the period 1947-1991. In tonnes.

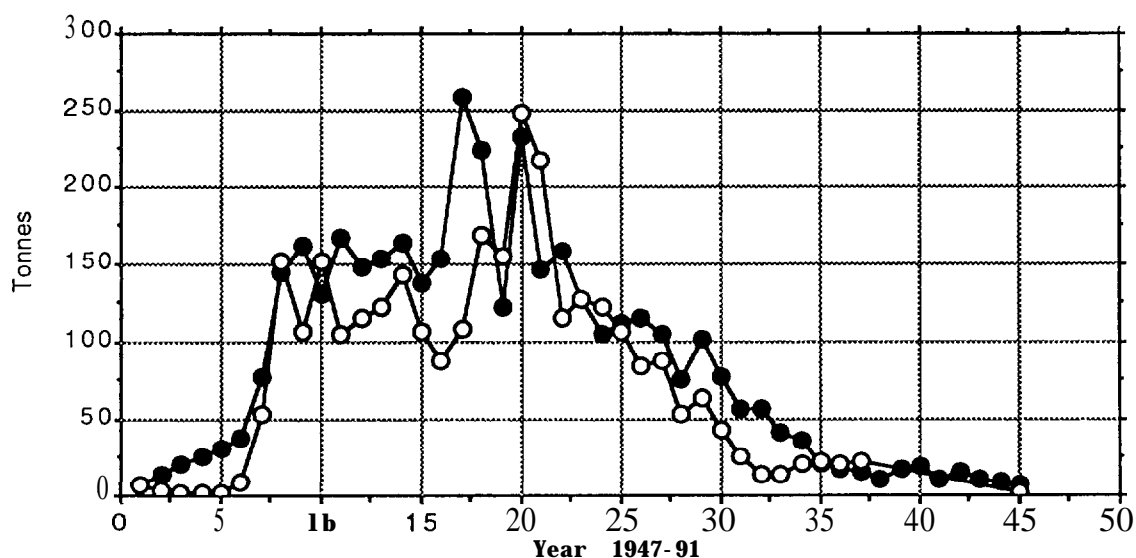

Environmental approach

Some examples are given on the effects of anthropogenic activities on coastal fish and fishery. They will demonstrate the effects from land to sea via the river systems, by the long-term changes in the sea water quality on the coasts, the reactions in areas affected by a complexity of factors at population centres, and effects at industrial point sources.

* It has been pointed out that estuarine areas and archipelagos are important for coastal fish and fishery. Finnish investigations have studied, e.g. the effects of acidification in an archipelago of the Gulf of Bothnia. A decreasing **pH** level in several rivers and bays affects coastal fish resources by causing reproductive losses (Urho et al., 1990). More than the acidification by precipitation, activities like the physical restructuring (drainage, dredging and embankment works) of sulphide littorina clays in a drainage area of a river contribute to these negative effects (Hudd et al., 1986). Toxicity tests show that young larvae are among the most sensitive to acidification.

The ranking of species sensitivity corresponds well with observations in other studies. Species that are particularly affected are those with their young stages in spring, e.g. burbot and coregonids. Other species, e.g. bream and pike-perch, spawn later and may, at least in some years, escape the spring minima of the **pH**. On the whole, burbot and bream have declined most because their nursery areas are confined to the estuary or to the influence area of the acidified river water. A large programme for stocking of fry has been initiated to save the coastal fishery on migrating whitefish.

Other investigations along the Finnish coasts of the Gulf of Bothnia give examples of a large series of areas affected by various types of interferences in the river systems. All types of basins built to ensure the supply of fresh water, production of energy, etc. prevent the spawning of various coastal species as well as availability of migratory species important for off-shore fishery like salmon. Other effects are the changed hydrological rhythm along the coasts during the year caused by the altered flow of river water or the above-mentioned acidification.

In fact, the sum of many, even relatively small, separate environmental changes, ends up in a kind of synergistic effect, which alters the stocks of fish, the available areas for spawning, nursery and fishing activities, etc.

The profitability of fishery along the Finnish coasts is considered to decrease. The close and traditional coastal fishery of a large number of species has already changed its character in many areas and has been replaced by fishery based on a few species, a change which, amongst others, has economic consequences.

The magnitude of this traditional coastal fishery is not as important in Sweden as it is in Finland, despite the fact that the character of the coastal zone in many ways corresponds with the Finnish coast. It is evident that the ambition in Sweden to increase coastal fishery in the future will, to a large extent, depend on the management of potential natural resources. Many of these are already affected in the same way as in Finland, e.g. river impoundments or industrial effluents.

* Five areas affected by effluents from pulp mills along the coasts of the Bothnian Sea and the Baltic Proper and producing bleached kraft have been studied regarding the species distribution and recruitment of coastal fish. Numerous effects have been demonstrated and a general pattern has been established, related to both organic enrichment and toxic pollution (Sandström et al., 1992). The reader is also referred to the effects discussed in the Chapter on chlororganics.

The abundance of fish is low close to the mills as a reaction to toxic or repelling substances. At an intermediate distance from the mills, fish biomasses are very high as an effect of eutrophication of favourable feeding grounds. This community is strongly dominated by cyprinids like roach. In some of the areas also other fish species like ruffe, bream or silver bream might increase in abundance at various distances from the mills.

An impaired production of fry is generally present and their abundance is low. The chronic gonad damage in exposed adults and acute toxic effects on newly hatched larvae are two likely explanations for the low survival of early life stages. The fish stocks observed should then mainly be an effect of immigration.

To sum up, the results appear to indicate an attraction of fish into a water area where toxic substances inhibit reproduction. Of course, this is especially negative in areas of potentially good prerequisites for fish recruitment.

* Nuclear power plants discharge vast amounts of cooling-water. The four Swedish plants are situated at the Bothnian Sea, the Baltic Proper, the Sound and the Kattegat. Extensive long-term field investigations are running since the 1970s at all plants and, as a complement, in the large Biotest Basin (1 km²) at Forsmark in the southern Bothnian Sea.

All ecosystem levels, from bacteria to birds, are studied, but fish has been given priority due to its economic importance and its capacity to migrate along temperature gradients. For each species and size there is a specific “optimum temperature” for growth. Fishes with high optima, “warmwater species”, e.g. cyprinids, perch and eel, have been found to be attracted to heated effluents most of the year, while “coldwater species” like herring, cod and salmonids are only attracted in the cold season (Neuman, 1983).

The reactions on the temperature gradients affect the species composition most profoundly at the Swedish west coast, where both cold- and warmwater species are well represented in shallow waters. At the east coast, the warmwater fishes already dominate under natural conditions. As the warmwater plume normally is restricted to the surface water, pelagic fish is affected in wider areas than demersal ones. Herring is attracted to the effluents at the east coast in winter and early spring, and extensive spawning often occurs close to the outlets.

As the temperature level is decisive for consumption and energy use, heated effluents affect survival, growth and reproduction. This influence is mainly relevant for warmwater fishes, as they stay in the heated water for longer periods. Perch, one of the most common coastal species in the Baltic, has been most thoroughly studied. Due to a substantially increased growth rate, the survival during the first year, when stocks are dimensioned, is increased (Karås & Neuman, 1981, Sandström, 1990). There are indications that fry from heated areas strengthen stocks in surrounding waters (Neuman & Andersson, 1990).

Not only perch fry but also older fish grow much better in the warm water (Neuman & Andersson, 1990). After the first year, however, the heating mainly affects survival negatively. One reason for this is that fish mature very early, which contributes to an energetic stress (Sandström, 1990). Another negative effect is that long exposure for elevated temperatures in autumn and winter disturbs at least the female gonad function in perch and to a greater extent roach (Luksiene & Sandström, 1993).

Enough experiences are gathered to enable future thermal power plants to be sited and constructed so as to enhance the local fish production substantially. Joint Nordic projects are established to find means of utilizing heat in a positive way in our cold water-climate - from water quality to fish.

* Extensive studies of eutrophication, including the reactions of the fish fauna, have been made in fresh waters as well as in locally polluted areas of various extents along the Baltic coasts. The primary response to enrichment is a general increase in abundance of all fish species. As eutrophication proceeds, many species decrease. Cyprinids (e.g. roach), however, continue to increase until the final phase is reached, when all species drastically decline. The identification of large-scale effects of eutrophication needs access to long-term series from locally unpolluted areas.

* Data exist from an area at the central part of the Swedish coast of the Baltic Proper (Neuman et al., 1988). The development in this area is shown in Figure 60. The amount of cyprinids has increased since the middle of the 1960s; the catches measured as kilograms per fishing effort had more than doubled by the end of the 1970s. This development is suggested to be an effect of eutrophication, an opinion supported by the reduced transparency of the water to almost half the values during the investigation period.

Figure 60. Trends in standardized gill net catches of cyprinids and the Secchi depth in a Swedish coastal area, Kvädöfjärden (lat. 58°N), unaffected by local pollution. The catches are presented as 5-year moving averages and are based on five samplings per year, 1962-1987 (Neuman et al., 1988).

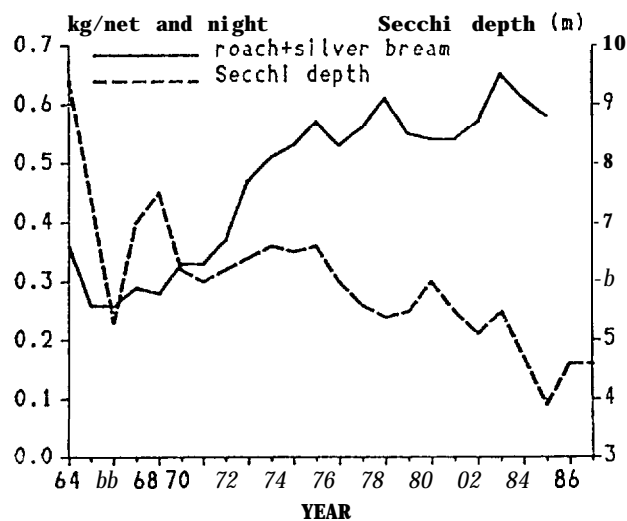

* The fish stocks and fishery in an area affected by a complexity of pollutants is demonstrated by Poland in the Inner Puck Bay situated in the northwestern part of the Gulf of Gdansk (Skora, 1992). Among the 48 fish species in Puck Bay, 20 occur throughout the year; others enter for spawning or incidentally.

Figure 61. Fish catches in Puck Bay (Skora, 1992).

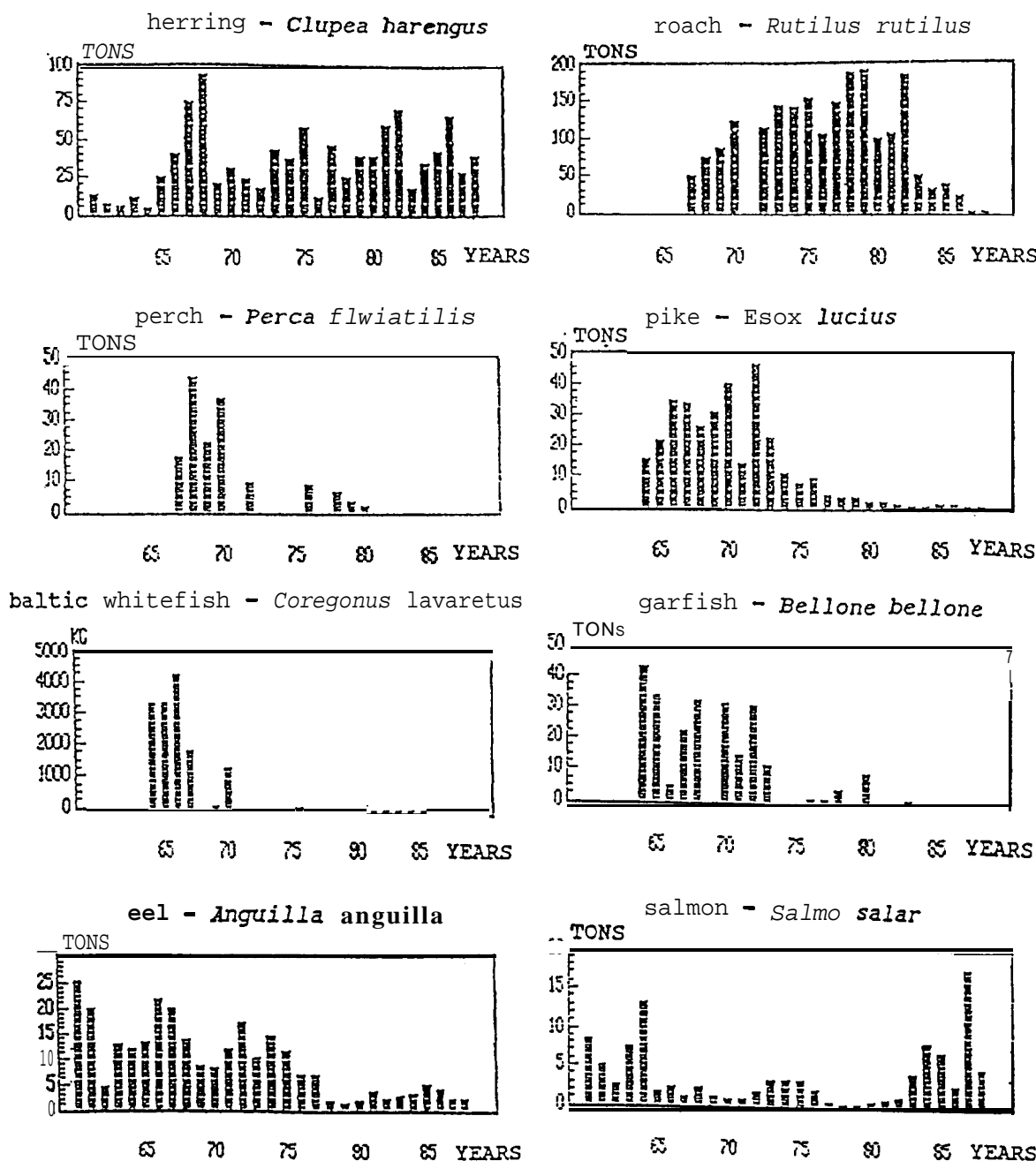

The development of some important species in the fishery is shown in Figure 61. Looking at the time series, the only two species remaining in the catches are herring and salmon. Herring is taken mainly when entering to spawn in spring and its relative importance in the total fishery is increasing. The catches of salmon are an effect of breeding and introduction as a compensation for the destroyed natural reproduction. All other species show a severe decline or are totally missing. Species like whitefish, garfish and pike are no longer fished in the area. The same pattern can be found in other areas, like in the Gulf of **Riga**. The relative persistence of cyprinids, like roach, reflects a situation similar to that reported above at the Swedish coast or the development described, for example, in a polluted area off Helsinki.

A secondary effect of pollution, e.g. the extinction of vascular plants in the Bay, diminishes the heterogeneity of the environment and favours the populations of sticklebacks (mainly the three-spined) which dominate the fish biomass of the area and are feeding on spawned eggs and hatched larvae, now lacking effective shelter. The uniform distribution of sticklebacks over the bottoms also obstructs access of other species to the feeding grounds. Other predators and competitors for the remaining resources are the gobiids.

* Fishery statistics are given from the Curonian Lagoon, including the Lithuanian as well as the Kaliningrad area, for the period 1947-1991. The results confirm the general pattern of changes in the composition of species observed in the Puck Bay, in the Gulf of **Riga** and the Swedish and Finnish areas. The detailed results over a long-term period of 45 years enable a more detailed analysis of the development.

During the last three decades there is a slow but steady increase in the total catches in both areas; a trend that might be broken during recent years. This differs from the development in the Gulf of **Riga**; easily explained by the availability of herring - a species which dominates the total catch in the Gulf of **Riga** and constitutes only a few percent in the total catches from the Curonian Lagoon.

There is a remarkable co-variation between the catches in the two main parts of the Lagoon even if some species like whitefish, bream and pike-perch have mainly been caught in the Kaliningrad area and vimba and roach in the Lithuanian region.

Besides eel, there has been a decrease of pike and vimba since the early 1960s and of whitefish and pike-perch reported from the last decade. The population of perch seems unchanged and that of **eelpout** has been on the same level from the 1940s to the 1990s, with a certain cyclicity in the catches. An increase can be noted for cyprinids like bream and roach, corresponding to the development noted at the Swedish coast. The definite increase of sticklebacks in the statistics is an interesting parallel to the situation described from the Puck Bay in Poland. The results for some fish species are **presented** in Figures 62 and 63. A summary of the fish species mentioned in the text is given in Table 25.

Figure 62. The catch of fish species in the Curonian Lagoon 1947-1991 in the Lithuanian (Lith) and Kaliningrad (Kalin) areas. Pike (a), vimba (b) and perch (c) in tonnes per year.

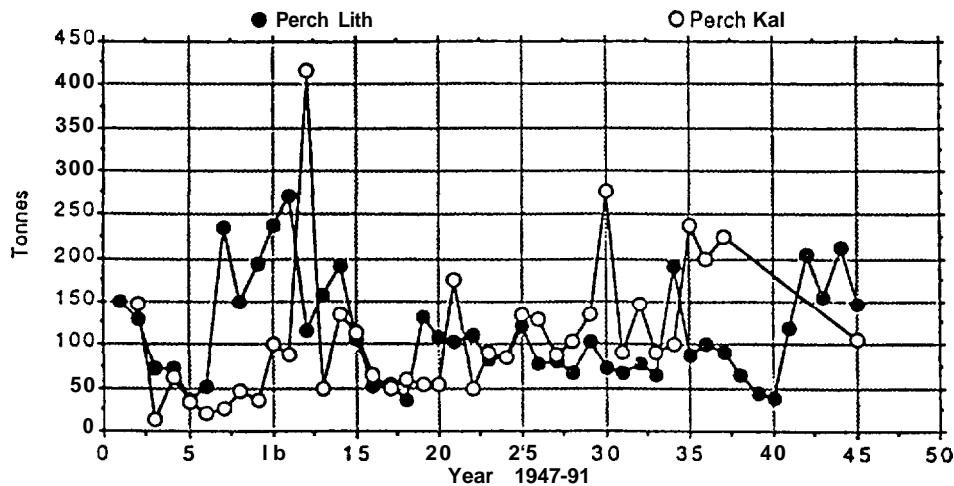
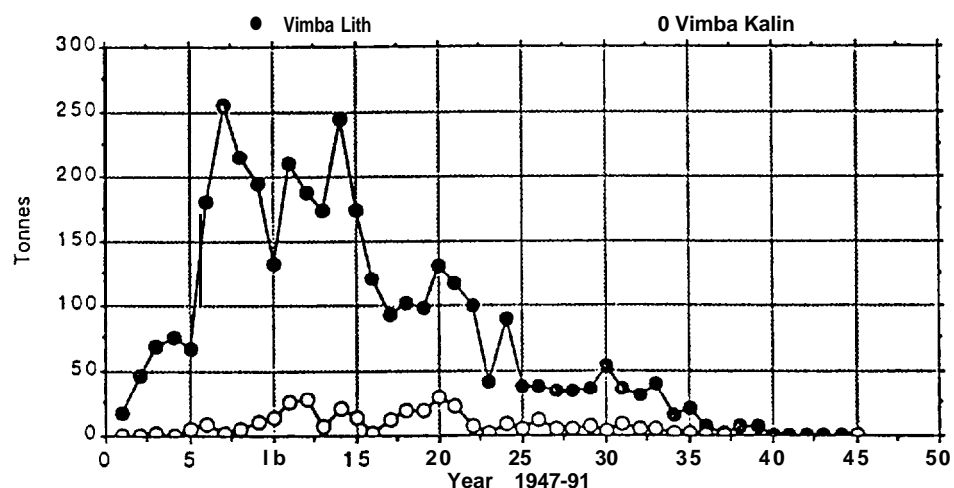
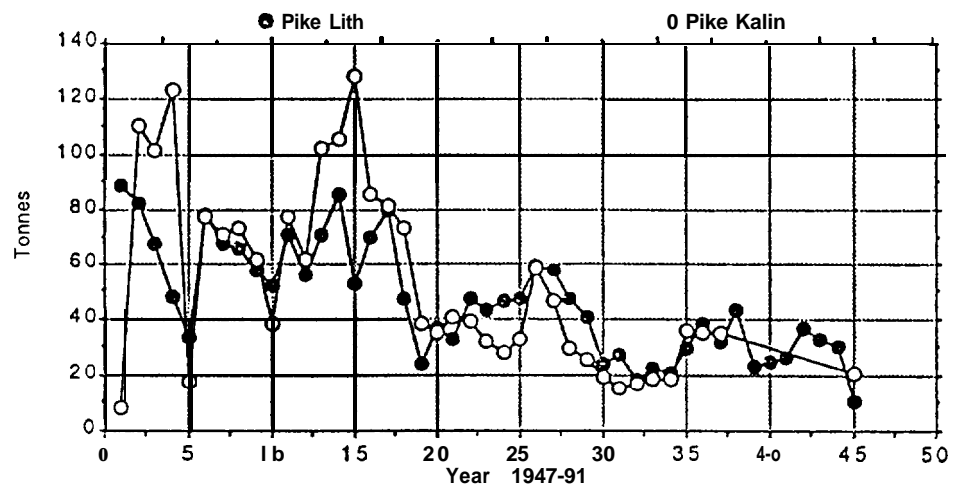

Figure 63.

The catch of fish species in the Curonian Lagoon, 1947-91, in the Lithuanian (**Lith**) and Kaliningrad (**Kalin**) areas. Roach (a), bream (b) and stickleback (c) in tonnes per year.

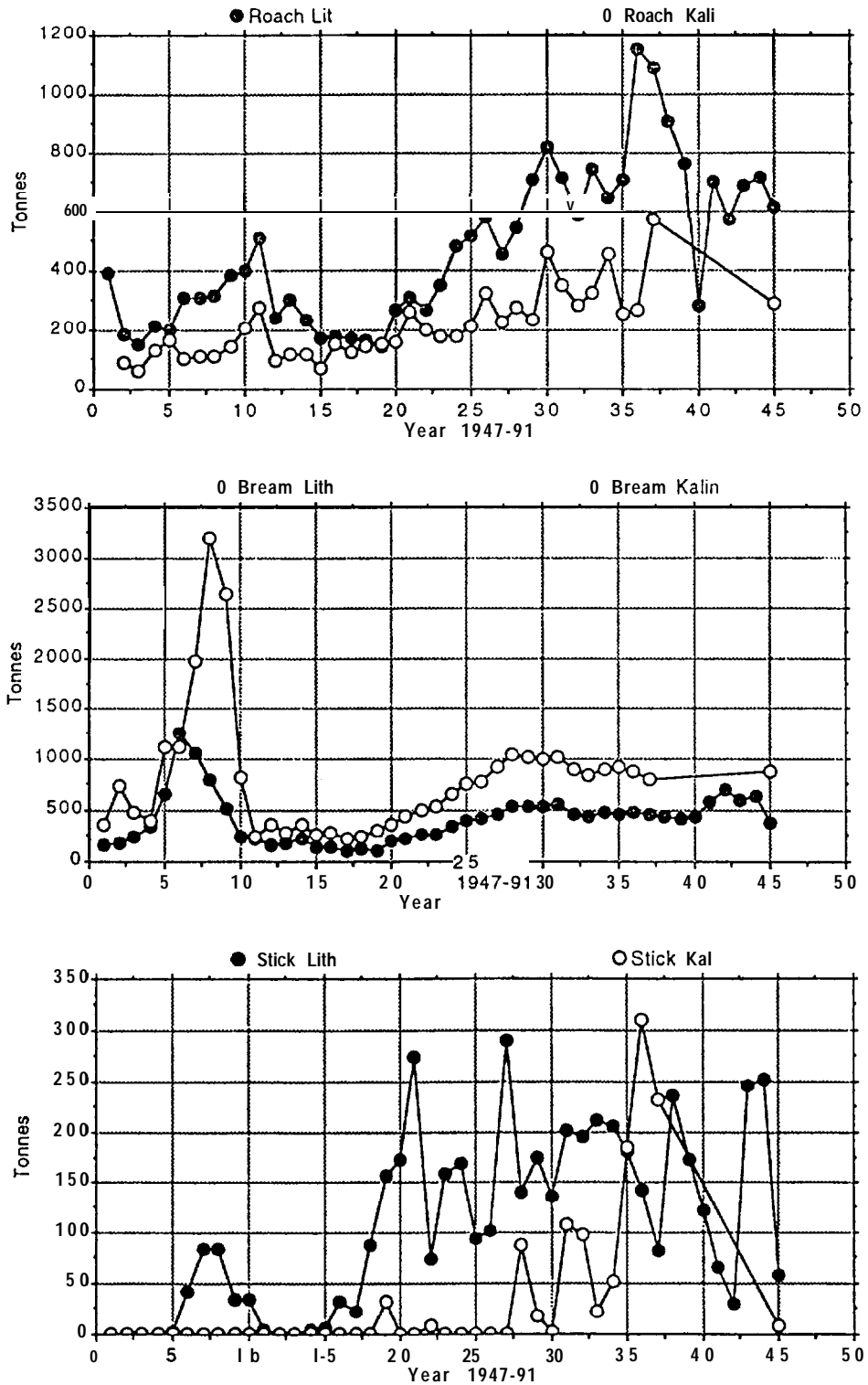

Table 25. Euryhaline and marine fish species mentioned in the text.

Species mainly caught in coastal areas

Lamprey	Lampetra fluviatilis
Twite shad	Alosa fallax
Garfish	Belone belone
sea-trout	Salmo trutta
Whitefish	Coregonus lavaretus
Vendace	Coregonus albula
Smelt	Osmerus eperlanus
Pike	Esox lucius
Roach	Rutilus rutilus
Ide	Leuciscus idus
Silver-bream	Blicka bjoerkna
Bream	Abramis brama
Vimba	Vimba vimba
Eel	Anguilla anguilla
Burbot	Lota lota
Perch	Perca fluviatilis
Pike-perch	Lucioperca lucioperca
Ruff	Acerina cernua
Bullhead	Gobiidae
Eelpout	Zoarces viviparus
Stickleback (3-spined)	Gasterosteus aculeatus

Species mainly caught in open sea

Salmon	Salmo salar
Herring	Clupea harengus
Sprat	Sprathls sprattus
Cod	Gadus morrhua
Flounder	Platichthys flesus
Plaice	Pleuronectus platessa

5.2. Sanitary conditions and bathing

The hygienic quality of the beaches is of great importance for general recreational purposes, tourism, etc. There are national as well as international standards and recommendations for control of the quality of water.

Among international guidelines can be mentioned those of the European Community (EC). One of the first directives within the EC in the environmental field was adopted in December 1975 (76/160/EEC).

The systems used for determination of the sanitary conditions, e.g. for bathing and swimming, are generally based on bacteriological examinations such as coliforms, streptococci, salmonella and enteroviruses of the waters. This control is often combined with analyses of physical and chemical parameters in addition to visual inspections. The faecal coliforms, often being the key parameter in the assessments, have a limited survival in marine waters. This directs the problems to near-shore and especially to the mixing zones between fresh water and seawater.

It is pointed out by all countries reporting on sanitary conditions that some beaches are particularly dependent on meteorological conditions, mainly the directions of wind or, e.g., a temporary cleaning up by a storm. In these cases, the period for prohibition of a beach is dependent on the frequency of regular controls or initiatives taken by local authorities. Within a wide archipelago, where the isolation and temporary stagnation of water exchange is frequent, the beaches are especially sensitive.

The various control routines, standards and categories applied differ between the countries. It is therefore necessary to present and comment data on an individual national basis.

A summary of presented material is found in Table 26.

Table 26. The limits for classification of Swedish beaches are given in numbers per 100 ml:

	Suitable	Suitable with reservations	Unsuitable
Presumptive <i>E. coli</i>	< 100	100-1000	> 1 000
Presumptive fecal streptococci	< 30	30-300	> 300
Coliform bacteria 35 °C		> 1000	

Routine sampling is done twice a month. An obvious deterioration in quality is immediately followed up by a new sample. Three successive results with bad quality will close the beach. Bathing is again permitted after three successive samples of good quality (SNV, 1989).

Altogether 847 beaches are controlled along the Swedish coast, of which 24 have been closed during 1990-91. The majority of the closed beaches are situated at the western and southern coasts and only seven along the east coast (SNV, 1992b, Local auth. pers. comm.). Most of the temporarily closed beaches (13) have shown a maximum number of E. coli up to 1 600 per 100 ml. In Stockholm county, including the large archipelago, 288 beaches are controlled of which 4 were temporarily prohibited for bath during 1990-91.

The maximum number of E. coli observed was 20 000 per 100 ml in July 1991 at a beach situated in the innermost part of the southern archipelago in the vicinity of the town Karlskrona. The specific situation, which has not happened in previous years, was induced by an accident at the sewage treatment works and the beach could be opened again after one week.

The second highest value with a maximum of 10 000 is also noticed in the southern part of Sweden and was followed by a series of values between 500 and 5000 during the summer. This means that this area was closed the whole summer. The reasons for the poor quality will be followed up and, unlike the former example, this beach is considered to be frequently polluted.

Finland

The classification of beaches concerns the number of thermotolerant coliform bacteria and the fecal streptococci per 100 ml. These values apply to both bacterial groups. Values below 100 indicate good conditions, 100-1000 moderate, while those exceeding 1000 indicate poor quality.

There is no national review concerning the hygienic quality of bathing waters. The following information is based on 50 beaches in five large Finnish towns (Helsinki, Turku, Pori, Vaasa and Oulu). In general, the hygienic quality of water was good on most study occasions. Bad quality occurred quite seldom; these observations have concentrated on beaches in inner areas where the water exchange is poor (Kangas, pers. comm.).

During the last 4-5 years, bans have been imposed only on two beaches in these towns. One beach in Vaasa was polluted in 1992, when the waste water pumping station broke down. In 1989, one beach in Turku was prohibited because of excessively high levels of coliform bacteria.

The water protection measures conducted are reflected in the hygienic status of bathing water: the present situation is clearly better than a decade or two earlier. For example, even one-third of all beaches in Helsinki (totally 19) were repeatedly classified as poor in the 1960s. Since then, in the 70s and 80s, only a few similar occasions have been recorded. During recent years, more than half of the beaches are classified as good in Helsinki.

Russia

The standard for Coli index in the former USSR for public beaches at the sea coast was 2500 per 100 ml and is still valid. No detailed information exists. The insufficient waste water treatment is, however, reported to cause large problems in the Kaliningrad area, especially in the gulfs. Even for the open coast the local authorities regularly propose closure or issue bathing warnings, e.g. for beaches in Svetlogorsk, Pionerskiy and Zelenogradsk.

Estonia

The standard requirement for Coli-index is **500/100** ml. At the beginning of the swimming season the permitted level might be 1000 and during the season up to 2500. The prerequisite of these values is the absence of a pathogenic microflora.

The **Pärnu** Bay is the most polluted area of the Estonian coastal waters (Mihkels 1991). The beaches, which have been known internationally, have been closed due to microbiological pollution. In summer, values exceeding 100 000 have been recorded. Also the Paralepa beach in Haapsalu Bay and Stroomi **beach** in Tallinn Bay have been closed to the public. Pathogenic microflora have been found only in occasional cases.

On the northern coast at **Toila-Oru** the status has slightly improved and no cholera-carriers have been found during the last two years. The best quality for bathing is reported from the islands of Saaremaa and Hiiumaa.

Latvia

Tourism in Latvia is today concentrated in the Jurmala region in the southern Gulf of **Riga**. The facilities in this area represent around 70% of the total facilities in the country.

Jurmala is situated close to **Riga** and to the mouths of the rivers Daugava and Lielupe, which means that the recreational value is greatly endangered due to contamination of the water. Microbiological studies performed show that satisfactory sanitary conditions of water were found only during the winter. The Coli-index may exceed the allowed limits up to 240 times and swimming has been frequently abandoned during the last two summers. Beaches of good quality and less pollution can be found in other areas. During the Soviet period, many of these areas were closed to the public for national security reasons and could therefore not be developed as alternatives to the Jurmala area.

Lithuania

According to the 1988 requirement, the Coli-index was 500 per 100 ml. After 1992 this standard is 100-500. The hygienic service permits beach exploitation when the Coli-index does not exceed 2500 and in the absence of pathogens.

During 1990-1991 three beaches in the vicinity of **Klaipėda** were closed five times. The sanitary conditions are affected by discharges from the town and by the directions of the wind. Maximum mean values for the season, **10000/100ml**, were reported from beaches at Melnrage during 1991. Via the **Klaipėda** Strait the mixture of river water and waste products follows the coastline closely and mainly northwards. The best water quality for bathing is also reported from the Neringa beaches facing the Baltic Proper along the coast south of **Klaipėda**.

Poland

The classification of the sanitary status is based on four quality groups of coastal water according to the value of **fecal** Coliform index with number of bacteria per 100 ml, increasing in a logarithmic scale:

I - up to 100, II - up to 1000, III - up to 10 000, IV - over 10 000

The seaside resorts are classified according to the above principles into four groups indicating their recreational value:

1. clean resorts with water in quality groups I and II;
2. uncertain resorts (permitted for use on certain conditions only) with 70% of water samples in quality groups I and II and 30% of samples in group III;
3. polluted resorts with less than 70% of samples in quality groups I and II; bathing is not permitted;
4. very seriously polluted resorts with less than 10% water in quality groups I and II. Access to the beach should be forbidden.

It is proposed by Poland that group 2 could be suitable for the heading “temporarily prohibited” in Table 26. After stormy weather, mostly out of the bathing season, sanitary conditions improve for some 1-2 weeks. Groups 3 and 4 represent only “prohibited” areas.

Figure 64. Sanitary condition of Polish coastal waters expressed as the three-year (1986-1988) mean MPN of fecal Coli bacteria (Sobol and Szumilas, 1992).

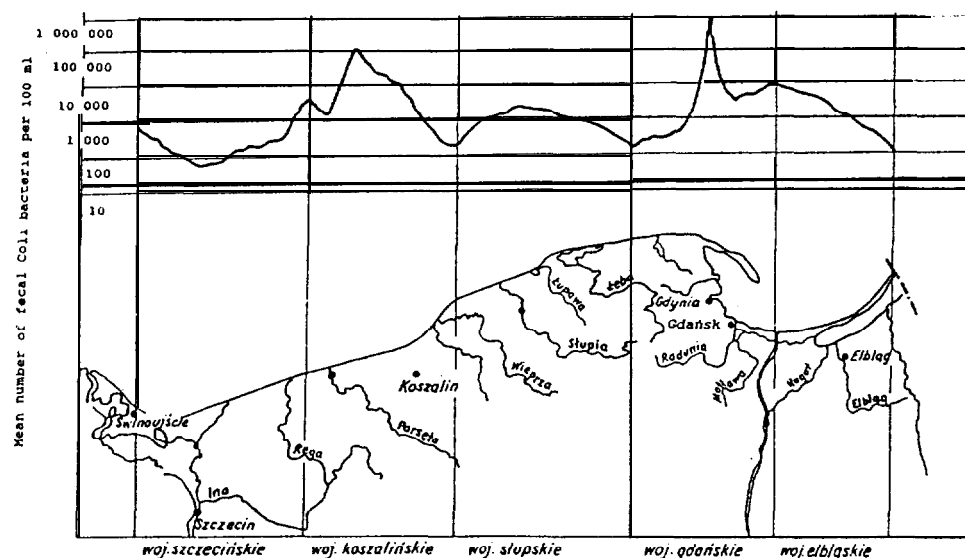

An analysis of a three-year study (1986-88) shows that the sanitary state of the sea water is worst affected by urban agglomerations along the coast, and to a lesser extent by all watercourses (streams, drainage channels and ditches) collecting wastes from farms, settlements and small towns (Sobol & Szumilas, 1992). The least polluted sector of the Polish coast is the Szczecin voyvodship in the westernmost area of Poland (Figure 64). A report, based on analyses in 1991-1992, shows that water classes 1 and 2 predominate in the Gulf of Gdansk and there is a clear tendency of further improvements (Maciejowska, 1993).

Germany

Due to the two political systems in Germany up to the unification in October 1990, different standards of sewerage systems and waste water treatments exist. The standards are now the same but the state of sewage treatment is still different. In Schleswig/Holstein, 86% of the population is connected to sewage treatment works, all of them supplied with biological treatment. In **Mecklenburg/Vorpommern** where almost the same percentage of the population is connected to a sewage treatment system, only 19% are connected to biological sewage treatment. This difference is reflected in Table 27. Recently, much effort has been spent to improve this situation.

The standards applied in Germany are presented in the following table:

<u>Bacter. & Viroloe. Parameter</u>	<u>Guide Value</u>	<u>Mand.Value</u>
Total coliform bacteria /100 ml	500	10 000
Faecal coliform bacteria /100 ml	100	2000
Streptococcus <i>faecalis</i> /100 ml	100	
Salmonella /1 000 ml		0
Enterovirus /10 000 ml		0

The bathing water complies with the guidelines if 95% of the samples do not exceed the mandatory or imperative values. Prohibition of bathing is imposed when two or more successive samples, determined fortnightly, exceed the mandatory values.

The results of investigations in 1991 at the coastline of Schleswig/Holstein, comprising 1216 samples at 106 controlled beaches, caused prohibition temporarily and only at one beach in **Eckernförde** Fjord, which corresponds essentially with findings in recent years.

Information from **Mecklenburg/Vorpommern**, taken from a leaflet, states that at the end of June 1991, about 200 beaches were controlled. In the inner coastal waters the EC mandatory values are exceeded frequently or regularly whereas only a small percentage of the open sea beaches is of poor quality.

Denmark

The classification of water quality for bathing mainly follows EC directives, with the exception of the number of *coli* bacteria, 1000 per 100 ml, which is half the value accepted by EC. This limit shall not be exceeded for more than 5% of the bathing season.

Data are presented together with a detailed bathing water map for 1992 (Miljø, 1992). The situation in Denmark as a whole, the western and inland waters included, shows improved conditions compared to 1991. In 1992/1991 there were 1307/1338 monitoring stations of which 1216/1199 meet the water quality requirements. Banned sites number 28/38 based at 42 monitoring stations and there were 54/68 doubtful bathing water sites.

A calculation of figures relating to the Convention area for 1992 gives a coastline of approximately 6000 km, of which about 4000 km are suitable for bathing. Taken together, the sites where bathing is prohibited, cover an area of about 10 km.

The numbers presented in Table 27 are those of the monitoring stations: 28 monitoring stations have prohibited bathing, which corresponds to 18 banned sites while the number of sites **with** doubtful bathing water quality is 44, i.e. equal to the number of monitoring stations with doubtful quality.

Table 27. National reports on total number of beaches controlled mainly during 1989-91 and decisions taken for bans on bathing.

Country	Total number controlled	Doubtful quality	Bathing prohibited
Sweden	847	23	1
Finland *	50	2	
Russia			
Estonia	33	2	4
Latvia			
Lithuania	13	1	4
Poland	70	21	29
Germany	306	1**	13***
Denmark x	960	44	28

* = Five towns

** = Schleswig/Holstein

*** = Mecklenburg/Vorpommern

x = monitoring stations (see text)

5.3. Boats and boating

General aspects

Recreational boating as well as professional sea traffic has an effect on the coastal margin where environmental effects are especially noticeable. The demands on the coastal quality range from large harbours to exploitation of local coastal areas for small boats or marinas.

Some general effects in fairways of shipping traffic are described, e.g. by Cato (1986), in the Gothenburg archipelago with drastic changes in the grain size distribution and organic content of the bottom sediment as an effect of increased shipping in the area (cf. Figure 65).

Similar problems might occur as a result of the frequent traffic by large ferry tonnage, e.g., within the archipelago between Sweden and Finland. An inventory of mechanical effects by ferry traffic on the shores of the Stockholm archipelago is presented by Granath (1992). Damage is demonstrated, amongst others, by erosion along the fairways.

Figure 65. Changes in properties of sediments in the Gothenburg archipelago during the last two decades (Cato, 1986).

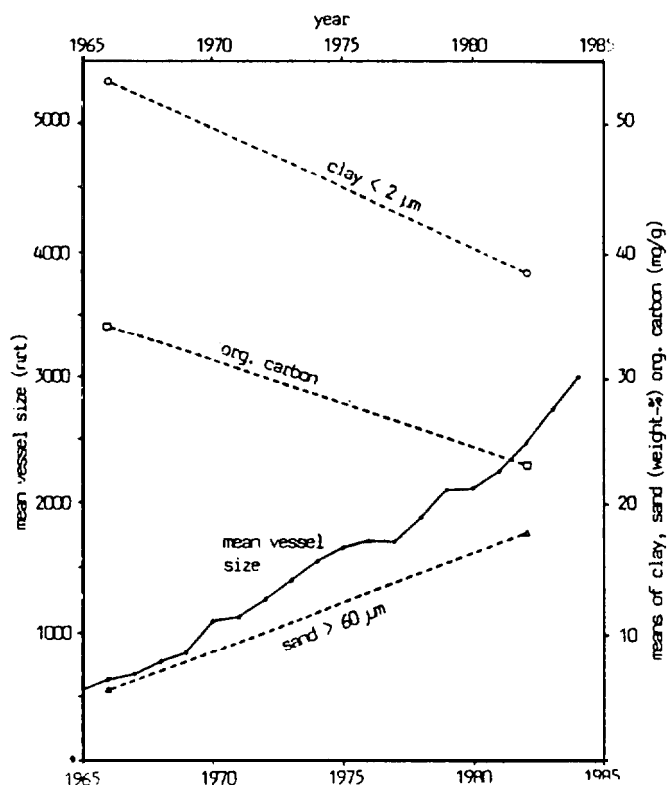

Ecological effects are also induced by surge along the shores (cf. Fagerholm, 1978). The redistribution of sediments means an impoverishment of organic sediments in directly affected shallow shore areas, affecting the diversity of species. In rock-pools exposed to the wash from ferries (“ferry pools”), on the other hand, the invertebrate fauna is rich in species as a result of the increased in-transport from the algal belt (Östman & Rönnberg, 1991). Growth and epiphyte biomasses were significantly higher on *Fucus vesiculosus* and contents of nitrogen and phosphorus were significantly lower at localities along the shipping route than at semi-exposed reference localities (Rönnberg et al., 1991). The highest number of epiphytic diatoms on green algae filaments (*Cladophora*) were recorded from open shores and close to the fairways (Rönnberg & Lax 1980).

Recreational boating

The use and importance of small boats for recreation and sport has increased extensively during the last decade and can be predicted to increase in many countries in the near future. As an example, the total number of boats in Finland is estimated to 600 000 of which about 75 000 are recreational motor boats suited for overnighting (Eloheimo, 1992b). In Sweden it is estimated that there are about 1.2 million recreational boats, of which 765 000 are motor-driven and about 200 000 suitable for overnighting (SNV, 1992a).

The register of potentially disturbing activities is broad. There are direct effects by spills of petrol, diesel, oil, sewage and littering plus effects of motor propellers, noise and surge. To this should be added the leakage of anti-fouling paints with, e.g., metals like copper, tin, and zinc. There are emissions to air including hydrocarbons, nitrogen- and carbon-oxides, etc. with secondary effects on water quality.

The problems have been followed up, e.g. by **Lundén** (1993) in Finland and are described in SNV (1992a) for Sweden. In this context, implementation of environmental labelling of marine engines by the Nordic Council of Ministers on a voluntary basis can be mentioned (**NFEL**, 1992).

Environmental effects

In principle, the same ecological effects in sediments and along shores given by the large tonnage of shipping traffic, can be expected to be caused by smaller boats bound for small harbours. The relatively local effects are counteracted by the large number of sites along the coasts. The marinas are also often located in sheltered and ecologically sensitive areas and demands for new sites are growing fast.

It is noted by Granath (1992) that similar or even more accentuated physical damage can be observed along the fairways of recreational boats in the inner archipelago, compared to shores in fairways affected by the heavy tonnage of ferries, and measured as a percentage of the total distance investigated.

Besides the effects of the ordinary traffic two specific problems are of interest for further elaboration; the antifouling paints and the establishment of harbours for recreational boats.

Paint

Specific interest has been devoted to organo-tin compounds, e.g., tributyltin (**TBT**) in antifouling paints. Several investigations and tests of biological effects can be found in the international literature (cf. Alzieu et al., 1980, Hall & Pinkey, 1985). Among summaries from the Baltic area can be mentioned **Björklund (1989)**, Cheng (1987), Lindblad et al. (1989), Laughlin & Linden (1991).

In the 1992 Convention, signed by all riparian states of the Baltic Sea, the decision was reached to ban paints containing organo-tin compounds for boats less than 35 metres and fish cages. The Convention is under the ratification process in the Contracting Parties. It should be mentioned that TBT was banned in some countries already in the late 1980s.

During 1993 new rules were introduced in Sweden which mean a total ban on toxic, antifouling paints for all boats below 200 kg, irrespective of water areas. A total ban is valid for all tonnage belonging to the Gulf of Bothnia, irrespective of boat size. For other coasts paints have to be approved by authorities, causing more rigorous restrictions for the Baltic Proper compared to the Kattegat as a result of the need for protection against potential fouling organisms.

In all countries where investigations have occurred, the results underline the marinas and harbours as being the primary source of TBT in the marine environment. In most cases there is a direct correlation of contamination with distance to these sources. The TBT can, thus, be regarded as a tracer of various waterborne pollutants from the harbours, if not obvious by other reasons, and apart from the various disturbances indicated above.

Localization of marinas

The effects of small boat harbours are discussed and advice for planning presented, i.a., by Degerman & Rosenberg (1981), Eloheimo (1992) and SNV (1992a).

Beside direct effects like leakage of pollutants, etc. mentioned above, there are specific problems linked to the constructions of harbours through dredging and filling, jetties, piers, canals and basins plus a complexity of activities for the support, repair, keeping, etc. of boats.

As in most cases where ecological disturbances can be expected by discharges to or building in water, the first and most vital decision to be taken into account is localization. No other measures have comparable consequences and dignities in situations where all other regulations and techniques are taken into account for the ordinary handling of vessels.

Among the series of recommendations given where localization is improper, can be mentioned the fresh-water inflows, areas protected for seals or birds, spawning-, nursery- and feeding grounds for fish, catching areas for fishery, sensitive terrestrial areas like sand dunes, shores close to bathing places, etc. The sites should have a depth more than 3 metres and good ventilation of waters. Already disturbed areas by other activities, e.g. industrial or municipal, are to be preferred. Consideration should be taken to the environment when constructing bridges, basins, sanitary facilities, etc. The lists presented are long and underline the overall activities to be taken into consideration in planning by the various authorities responsible.

Besides the lines of directions mentioned, there are legislations and recommendations given at various levels, internationally and nationally. There are regulations for reception of wastes in ports prepared, i.a. by HELCOM. General advice is given on a national basis, in Sweden, e.g. for regulation of sea traffic, health protection in leisure boat harbours, boat-racing, design of cleaning stations against fouling organisms, use of water scooters, etc.

REFERENCES

- Alzieu, C., Thibaud, Y., Héral, M. & B. Boutier, 1980. Evaluation des risques dus à l'emploi des peintures antisalissures dans les zones conchylicoles. - *Rev. Trav. Inst. Pêch. marit.*, 44, 301-348. (in French).
- Björklund, I., 1989. Organotin in the Swedish aquatic environment. - KEMI Rep., Sci. and Techn. Dep., No 8189, 50 pp.
- Cato, I., 1986. Sedimentens belastning av tungmetaller och n&alter i Göteborgs skärgård 1982 samt förändringar efter 1966. - Göteborgs Marineol. Inst., Report 2, 95 pp. (in Swedish).
- Cheng, Z., 1987. Monitoring and assessment of trace metals in seawater and marine organisms. - Miljöst. havföroreningslab., Charlottenlund. (mimeogr.).

- Degerman, E. & R. Rosenberg, 1981. **Miljöeffekter av småbåtshamnar och småbåtar.** - SNV, PM 1399, 122 pp. (in Swedish).
- Eloheimo, K., 1992b. **Båtlivet och dess miljöeffekter.** - Short presentation 30.6.1992 of research report: Veneily ja sen ympäristövaikutukset, Vesi- ja Ympäristöhall. Julk., 101, 105 pp. (in Finnish). Public. Ser. A 101.
- Fagerholm, H-P., 1978. The effects of ferry traffic (**artificial** wave action) on the rocky shore macrofauna in the southern Åland archipelago in the northern Baltic. 2. The Fucus zone (a quantitative study). - Kieler Meresforsch., 4, 130-137.
- Granath, L., 1992. **Farledsstränders erosionskänslighet.** Inventering av strandtyper och skador i Stockholms skärgård. - Forskningsrapport. Länsstyrelsen, Stockh. Län, 1992: 10, 71 pp. (in Swedish).
- Hall, L.W. Jr & A.E. Pinkey, 1985. Acute and sublethal effects of organotin compounds on aquatic biota: an interpretive literature evaluation. - Crit. Rev. Toxicol., 14, 159-209.
- Hildén, M., Hudd, R. & H. Lehtonen, 1982. The effects of environmental changes on fisheries and fish stocks in the Archipelago Sea and the Finnish part of the Gulf of Bothnia. - Aqua. Fenn., 12, 47-59.
- Hudd, R., Urho, L. & M. Hildén, 1986. The effects of anthropogenic acidification on the stocks and fisheries of bream and burbot in the sea area influenced by the River Kyrönjoki in the Gulf of Bothnia. - Publ. Water Res. Inst., 68, 134-138.
- Karås, P. & E. Neuman, 1981. First year growth of perch (*Perca fluviatilis* L.) and roach (*Rutilus rutilus* L.) in a heated Baltic bay. - Rep. Inst. Freshw. Res., Drottningholm, 59, 48-63.
- Laughlin, R.B. & O. Linden, 1991. A review of the environmental effects of tributyltin use. - Swed. Env. Res. Inst., No B91065, 43 pp.
- Lindblad, C., Kautsky, U., Andre, C. Kautsky, N. & M. Tedengren, 1989. Functional response of *Fucus vesiculosus* communities to tributyltin measured in an in situ continuous flow-through system. - Hydrobiol. 188/189, 277-283.
- Luksiené, D. & O. Sandström, 1993. Reproductive failure in a roach (*Rutilus rutilus*) population affected by cooling water discharge. (manuscript).
- Lundén, K., 1993. **Sjöfart och miljö, fartygstrafikens utsläpp av avgaser.** - Publ. Center for Marit. Stud., Univ. Turku., B52, 28 pp. (in Finnish and Swedish).
- Maciejowska, M., 1993. Evaluation of sanitary conditions of coastal areas along the Polish coast of the Baltic Sea, Gulf of Gdansk and the Puck Bay in 1991 and 1992. - Report, Mar. Biol. Center. (mimeogr.).
- Mihkels, A., (Ed) 1991. Environment '90, Estonia. - Ministry of Env., Republ. of Estonia, Tallinn 1991, 102 pp.
- Miljø, 1992. Badevandskort 1992. - **Miljønyt** nr. 5, 123 pp. (in Danish).
- Neuman, E., 1983. Thermal discharge and fish fauna in Sweden. - Wat. Sci. Techn., 15, 67-87.
- Neuman, E. & J. Andersson, 1990. Biological investigations off Oskarshamn nuclear power station during the 1980's. - SNV, Report 3846, 31 pp.
- NFEL (Norwegian Foundation for Environmental Labelling), 1992. Environmental labelling of marine engines (Translation from Norwegian). - Criteria Document, effective September 18, 1992, 4 pp.
- Rönnerberg, O. & P.-E. Lax, 1980. Influence of wave action on morphology and epiphytic diatoms of *Cladophora glomerata* (L.) Kütz. - Ophelia, Suppl. 1, 209-218.
- Rönnerberg, O., Östman, T. & K. Adjers, 1991. *Fucus vesiculosus* as an indicator of wash effects of ships' traffic. - Oebalia, Vol. XVII, 1 Suppl, Taranto (Italy), 213-222.
- Sandström, O., 1990. Environmental monitoring at the Forsmark nuclear power plant. - SNV, Report 3868, 37 pp.

- Sandström, O., Neuman, E. & P. Karås**, 1992. Pulp mill effluent effects on species distributions and recruitment in Baltic coastal fish. - *Fin. Fish. Res.*, 12, 101-110.
- Skora, K., 1992. Fishery. In: *Marine Pollution (2). An assessment of the effects of pollution in the Polish coastal area of the Baltic Sea, 1984-1989.* *Studia i Materialy Oceanologiczne*, 61, 205-220.
- SNV, 1989. Strandbad. **Kartläggning** av vattenkvaliteten 1991. - SNV, Rapport 4022, 185 pp. (in Swedish).
- SNV, 1992a. **Miljöpåverkan från fritidsbåtar, fiske- och arbetsfartyg.** - SNV Rapport 3993, 23 pp. (in Swedish).
- SNV, 1992b. Strandbad, vattenkvalitet och kontroll. - SNV **89:4**, 29 pp. (in Swedish).
- Sobol, Z. & T. Szumilas, 1992. Sanitary conditions. - In: *Marine Pollution. An assessment of effects of pollution in the Polish coastal area of the Baltic Sea, 1984-1989.* - *Studia i Materialy Oceanologiczne*, 61, 149-165.
- Thurov, F., 1991. Fish and fisheries in the Baltic Sea. - ICES Dialogue Meeting, Gdynia, Sept, 1991, 21 pp.
- Urho, L., **Hildén, M.** & R. Hudd, 1990. Fish reproduction and the impact of acidification in the **Kyrönjoki** River estuary in the Baltic Sea. - *Envir. Biol. Fish.*, 27, 273-283.
- Östman, M. & O. Rönnberg**, 1991. Effects of ships' waves on rock-pools in the **Åland** archipelago, northern Baltic Sea. - *Sarsia* 76, 125-132.

6. CONCLUSIONS

General

The over-all goals for the management of the coastal zone, formulated in the Interim Report (HELCOM, 1991), are still valid for the future work on measures to be taken.

It should be possible to:

- * enable a vigorous and balanced life in the coastal areas;
- * enable a natural zoning of flora and fauna;
- * prevent the occurrence of harmful oxygen deficiency;
- * carry out regular, long-term fishing;
- * consume **fish** and shellfish from these areas without risk to health;
- * ensure that human activities do not restrict the recreational values of coastal areas.

Large-scale and far-reaching effects are induced in the precipitation areas as well as direct interferences in the coastal margin. Acidification, waste discharges or changes in the annual rhythm of freshwater inflow in combination with immediate effects by various physical constructions in the coastal zone are just some examples given in the Report. They illustrate definite changes of coastal habitats with consequences for a multi-purpose use of the coastal waters. Such a use should be the aim of future policy and management. The specific aspect of recreational value is especially relevant for this contact zone between man and sea.

This Assessment Report of coastal areas to the Convention is a tool for future decisions to be taken and introduction of mutual activities. When looking at the map given by HELCOM (1992c), which describes important sources of pollution entering the Convention area and, on the other hand, the pattern of problem areas for water quality, there is correspondence between the two information bases available. The heavy sources are echoed by areas of poor quality. The general messages from Figure 66 are main industrial problems along the northern and western coast of the Baltic, municipal hot spots off large towns, eutrophication in the outlet region of the Baltic Proper and Kattegat, and a combination of various problems along the southern and eastern coasts.

Deviations in details from the two patterns are rather easy to explain. As examples can be mentioned the compact message of eutrophication in the southwestern Baltic and the Kattegat which, to a great extent, is a result of a total and/or diffuse load and, just partly, an effect of point sources within the area. Some of the problem areas for metals, indicated along the Swedish east and the Finnish west coasts, are based on results from old control investigations where measures taken during the last decade have improved the ecological quality.

Figure 66. Main problem areas indicated in national reports.

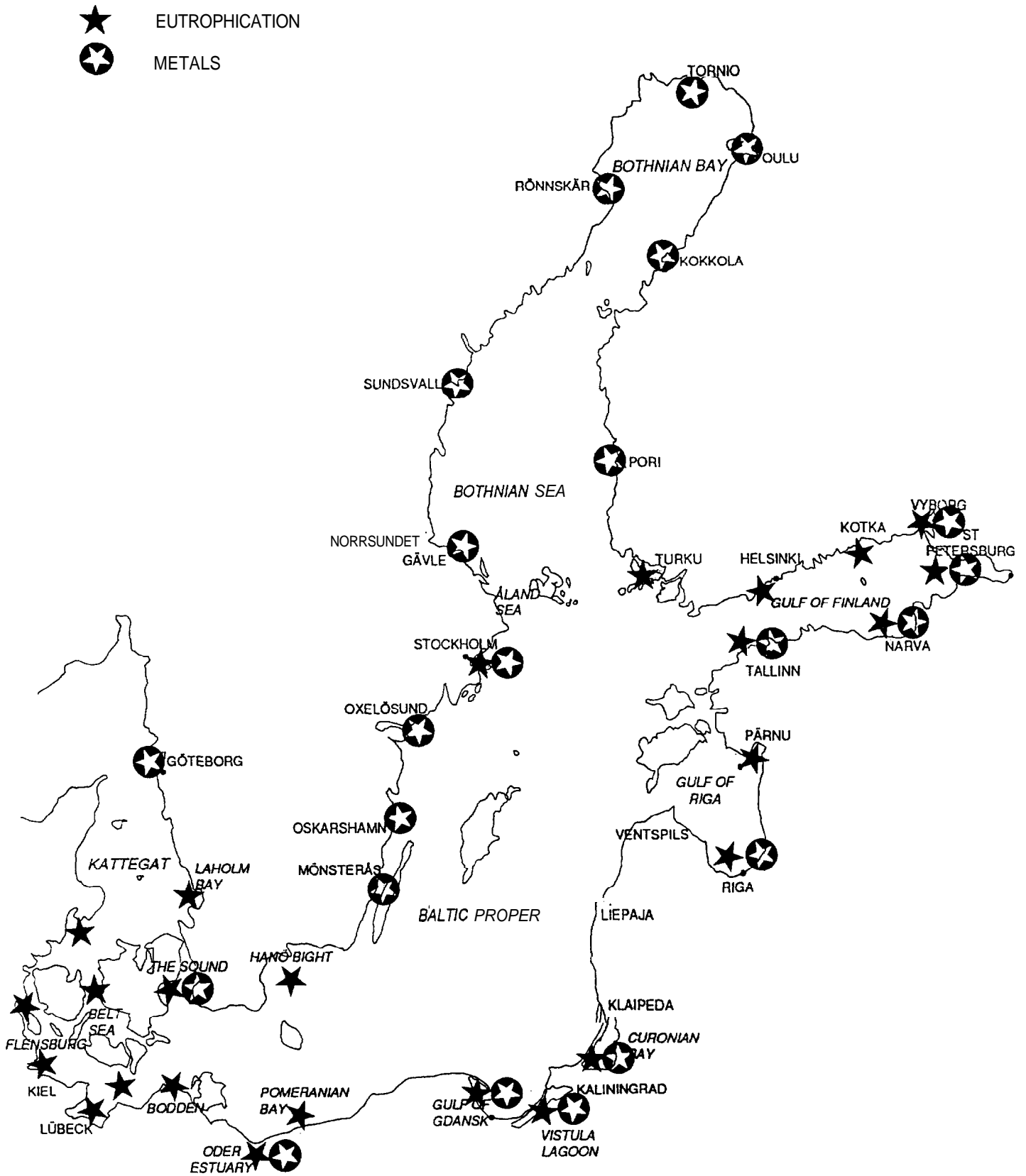

Local and regional approach

The limits between local and regional effects are difficult to define. It should be underlined that any attack on local pollution will have effects not only for the local area but very often for the Baltic Sea as a whole.

The eutrophication that results, for example, in seasonally poor oxygen conditions in a local area, is a matter of concern not only for local planning but for the main approach of regional quality. Such areas are relatively limited compared to the large, de-oxygenated deep bottoms. On the other hand, these areas often occur in archipelagos or other semi-enclosed basins, where their natural function of sieving and cleaning capacity can be changed dramatically, and where they may end up as source terms with a leakage of pollutants during long periods before recovery. The same function is valid for many hazardous substances where the balance between retention and leakage of elements often is connected to the redox-potential in sediments.

A fact that strengthens the regionalization of local effects is the dominating water transport system in all main basins, which carries pollutants anti-clockwise and normally presses the discharged pollutants against the coastal areas "downstream". There are reasons to believe that combination effects can be expected when various discharge plumes from rivers, industries or/and towns are mixed. One example of this that effects planning, is the **localization** strategy of large cooling water discharges "upstream" of heavy industries or towns, since an over-temperature has a relatively short residence time in water compared to other, more conservative elements.

Thus, most of the seemingly local problems have potential regional effects. Local effects, however, are not necessarily always induced by local sources.

Local areas also reveal large-scale changes in the open sea. Good examples are the reactions in the shallow Bights of Laholm and **Skälderviken** in the south-eastern Kattegat, where a background capacity for eutrophic conditions was built up during a long period, documented by the increased production of benthic green algae. Suddenly, the situation became acute, with a series of years of oxygen depletion during periods of poor water exchange followed by extinction of benthic animals and the fleeing of fish from the area. Obviously, such a reaction with oxygen depletion is possible even in wide-open waters like the west coast of Denmark where a good capacity of oxygen transport should be available.

Another message in the Report is that problems are not always introduced from land and out towards the open sea. There is a biological import of, e.g. hazardous substances, from open waters to the coastal zone by predators like seals or fish-eating birds, dwelling and reproducing mainly in the coastal zone but living on fish like herring and, thus, representing the conditions of the open sea. Other, more adequate transport mechanisms, are those of nutrients or metals, e.g. nitrogen and lead, where concentrations are built up to a certain extent in open waters by atmospheric deposition and transported into the coastal zone.

Fishery; a topic with wide applications

Fishing activities have a broad aspect and are expected to develop very rapidly, engaging more people along all coastal areas. The availability of fish in the coastal zone has a complicated background but is, as noted in the Report, mainly a result of the general quality of waters. It is also affected by local conditions, e.g. the content of hazardous substances like mercury. Loss of spawning or nursery grounds, either as a temporary effect, e.g. by dredging, or a long-term effect by reclamation of the coastal zone, always leave a “memory” in the form of lost generations of fish. The prerequisites for developing coastal fishery, whether a question of recreation or utilization of food resources in a bigger scale, has to be taken into account in economical as well as ecological planning.

Potential combination effects discussed in various chapters in the Report of which quality of fish is one example, provide the reason for the first, general recommendation. There is a need for simultaneous measures to be taken against the two main problems in the Baltic; eutrophication and hazardous substances.

Operative aspects

The problems introduced by local or large-scale influences are often to be approached by separate means, even if a common measure is limitation of input of pollutants. The responsibilities for quality of coastal waters are usually divided between authorities at various organizational levels, from central to local. There are also differences between countries in regulations or recommendations.

The control mechanisms are based on variable national systems. These include, amongst others, monitoring of the coastal zone, which is intended to provide information on the consensus between inputs and effects as a background for measures to be taken. The follow-up of measures taken to reduce deleterious effects is just as important.

Specifics about eutrophication

Principles

One general and large-scaled process, which definitely affects the coastal zone, is eutrophication. Serious physico/chemical and biological effects can be demonstrated and are reported by all countries: changed light climate in water, oxygen deficiency, extinction of organisms or a changed balance between species at all **trohic** levels of the ecosystem with, not least, economic consequences.

It is evident that measures have to be taken by all countries of the Convention and such measures have also been adopted.

Many questions are, however, still under discussion. There are no disagreements concerning goals and needs for action. The discussion has more to do with the means and degree of sophistication of techniques for a long-term strategy in the battle against eutrophication.

It has been demonstrated in this Report that all sources have to be taken into account when looking at coastal conditions. There is an input of organic matter from outside waters (allochthonous) introduced by rivers, industries, municipalities and a stimulation of the internal production of organic matter (autochthonous) in the marine waters by input of nutrients carried by air and water.

Scientists are still discussing these questions, especially those dealing with limiting nutrients, which have to be solved in the near future concerning open waters. The ways to handle problems of coastal areas seem more obvious. Even if the cause/effect pattern is more patchy in the coastal zone, the strategy seems to be clearer.

Recommendations

Taking into consideration attainable goals relating to future quality of coastal waters, the first step might be to eliminate organic (allochthonous) matter introduced through point sources. The second step should be to extend the system of sewage-water treatment and techniques to reduce airborne nitrogen. It is important that measures are taken to reduce the diffuse sources, like leakage from agriculture.

In the meanwhile, the discussion should be continued and recommendations given by experts on the importance of measures, apart from those already decided, concerning nutrients. A paper on this specific problem has been introduced into the Coastal Assessment Group through national contact persons and discussed by specialists in the various countries.

As could be expected, all specialists accepted an obvious positive effect by a decrease of both nitrogen and phosphorus into the waters of the Convention. Looking at alternatives between nitrogen and phosphorus as “limiting nutrient”, the reactions were not unanimous. The question is, nonetheless, brought up for consideration and cause/effect models have been presented as background and are available for further elaborations.

Specifics about hazardous substances

Metals

Principles

The evaluation of risk of metals is usually based on two sets of data; the load on and the levels in the environment. Existing or changing levels in biota are, when available, regarded as being more relevant than those of water and sediment.

The main problem is that data on effects are rare. There is a general tendency for levels of metals to increase towards the coasts, e.g. as a result of the prevailing water transport system. This is modified by the significance of airborne fallout for many metals or content of organic matter in sediments. The contributions from individual point sources are, however, decisive for the state of many coastal areas.

With the principle of multiple usage in mind, there should be protection against an over-loading of the marine areas. In fact, a good status can be achieved within a much shorter time in local coastal areas than in the large water areas, and to the benefit of the direct contact zone between marine environment and man.

Recommendations

Resides principles mentioned above, there is a proposal that the load should not exceed 50% of the natural background supply of metals. The percentage reduction needed to reach this goal has been calculated and is presented in Table 28.

The comparatively high salinity in the Kattegat suggests that there is a reduced demand for zinc and cadmium down to 100 per cent of the background. Lead has a short residence time in water and the availability in the marine biota is low in relation to the load, which means a decreased level of ambition down to 200 per cent of the background.

Table 28. Calculated percentage reduction of the presented total load of metals to reach an anthropogenic load less than 50% of the background. For zinc and cadmium, the additional load for the Kattegat is 100% and for lead in the whole area it is 200%.

Metal	Bothnian Bay	Bothnian Sea	Baltic Proper	Kattegat
Hg	80	80	90	90
Cd	40	80	90	70
As	< 50	< 50	< 50	< 50
Zn	20	75	70	50
Cu	20	50	60	50
Pb	< 50	50	70	70
Ni	< 40	40	< 40	< 40
Cr	< 50	< 50	< 50	50

Mercury and cadmium have been given the highest priority for reduction. These two metals imply a specific threat in the future to environment and man. For mercury, there are already certain concentration limits and recommendations for consumption of sea food. Cadmium is accumulated in the depth of the Baltic Proper and especially in de-oxygenated areas, which cover about 50 per cent of the total basin area. During occasionally oxygenated periods caused by inflow of marine water or, in the long-term perspective, a successful action against eutrophication and a more oligotrophic character of the Baltic, there will be a release of the deposits of cadmium into the water phase, affecting biota in all areas and including effects on man.

As emphasized above, it is, however, important to take into account the situations in local areas. Bad situations can be restored, e.g. in the surroundings of populations centres, where restrictions on recreational activities should not exist.

The results of calculations and the priority recommended for measures taken against metals are presented in Table 29.

Table 29. Proposals of measures to be taken against metals. There are three levels, depending on status: ***= highest priority for open sea as well as coastal zone, **= high priority for parts of sea areas, *= decided limitation of discharges (50%) acceptable for total sea areas.

Metal	Bothnian Bay	Bothnian Sea	Baltic Proper	Kattegat
Hg	***	***	***	**
Cd	**	***	***	**
AS	**	**	*	*
Zn	*	**	*	*
Cu	*	*	*	*
Pb	*	*	**	*
Ni	*	*	*	*
Cr	*	*	*	*

It should be mentioned that lead (Pb) is a metal with potential serious effects in the environment, even if not especially noted in marine habitats. It is, however, a fact that especially high concentrations of lead are noted in the south-eastern part of the Baltic Proper which motivate high priority of input reduction to these coastal areas.

Whatever the quantity of metals or techniques of disposals creating problems in local environments, they have to be reduced. In any case, the emissions of mercury and cadmium should be decreased for reasons mentioned. The need for a common routine control programme has to be underlined with regard to common interests. This is of importance for understanding of measures taken and for prognoses in the future.

Organics

The damage by chronic release of petroleum hydrocarbons is under steady observation and belongs to the topics of importance for an isolated sea area like the Baltic Proper. Until now no special effects have been noticed apart from in local areas close to, e.g. harbours. The methods and techniques of remediating accidents are under continuous development.

The chlorinated hydrocarbons are a growing problem. Some of the substances like concentrations of **HCHs** or the **DDTs** and **PCBs** are decreasing in the Convention area. Some of them are, however, still problems for survival of important, high ranked **trophic** groups of animals.

The chlorinated hydrocarbons represent a category of elements, which give good examples of the declaration in the Report of a close dependence between the levels of eutrophication and effects of hazardous substances. Examples can be taken from the development of top predator populations, e.g. fish, seal and otter.

Recommendations

Many of the halogenated organic substances used are regarded as toxic. In many of these products, chlorine is nowadays replaced by bromine which makes the effects of polybrominated substances just as important to follow-up in environment.

Their artificial background gives them a specific position among the persistent and bioaccumulative pollutants. There are no background concentrations acceptable, as is the situation for metals, of which many are essential for organisms in micro-quantities.

It seems quite clear that many of the traditionally followed-up elements should still be under control as long as their behaviour in the biosphere is not fully understood. The Report shows very clearly that effects on populations or whole communities belonging to and depending on the ecosystem of the coastal zone are fragmentary.

With the dramatic fate demonstrated for many species living on the products of the open sea in mind, there should be efforts to review the strategic food chains exclusive to coastal waters. There is **clear** evidence that these areas are of importance for whatever geographical and ecological dimensions chosen. There are still analytical problems to be solved but many routines are available and can be implemented to provide better knowledge of the coastal zone.

There is a desire for possibilities to keep all new elements in circulation in the environment under control. It is also well known that a routine programme for all elements will consume more resources than available today for control observations. The development of analysing techniques and evaluation of results is a must for future work. Until now, it has been given the dimensions of problems. The way from research to routines in a common monitoring programme still has to be given a more practical approach and a step by step development by intercommunication between specialists is urgent for future activities.

Specifics about recreation

Measures taken for a desirable quality of the coastal water could be recommended without special motivation as a background cover note. All people, the readers of this Report included, know exactly what quality is desirable along the shores.

The obvious conditions, noticed by people making use of coastal areas for various reasons, e.g. swimming, fishing or just visiting, are often a local dirtiness. This is an experience mainly gained close to urban areas, where the need for clean shores and waters are most desirable. There should be an assurance for actions provided by local authorities to master these effects.

It seems also possible that the economy for an obvious and observable cleaning up of waters near urban areas is reasonable compared to the main background situation based on large-scale improvements of basin qualities. It seems also possible to re-open new recreation areas in the coastal zones, until now withdrawn from use for various reasons.

In this context it should be noticed that many activities within the framework of recreation have, for their own reasons, to be under observation. As examples, bathing quality is already monitored, and the development of other activities like boating is **recognized**.

Recommendations

Besides the recommendation for a cleaning up of coastal areas in general and those of interest for recreation in particular, common guidelines should be worked out within HELCOM for location and management of marinas and similar constructions in the future.

Future activities

This Chapter should end with some comments on future activities. There is a definite wish by the Convention, expressed through its Environment Committee, to define a common monitoring programme for coastal areas, which might be harmonized with the running programme for the open Baltic.

The knowledge we possess today underlines the need for such a programme for all main topics. The requirements for an initiation of mutual monitoring activities have been demonstrated in the Report in order to gain information and comparable results for future measures to be taken. The **normalization** of results into comparable magnitudes or units in space and time is necessary.

It is recommended that in the initial stages of this development of techniques an intercalibration is included of already existing routines applied in most countries. The development of such a programme will further strengthen the readiness of efforts to be **mobilized**, which was expressed by responsible authorities in the various countries.

Finally, there is a proposal to **harmonize** the programme with other international monitoring activities when appropriate, with attention given to the specific demands dictated by characteristics of the Baltic area.

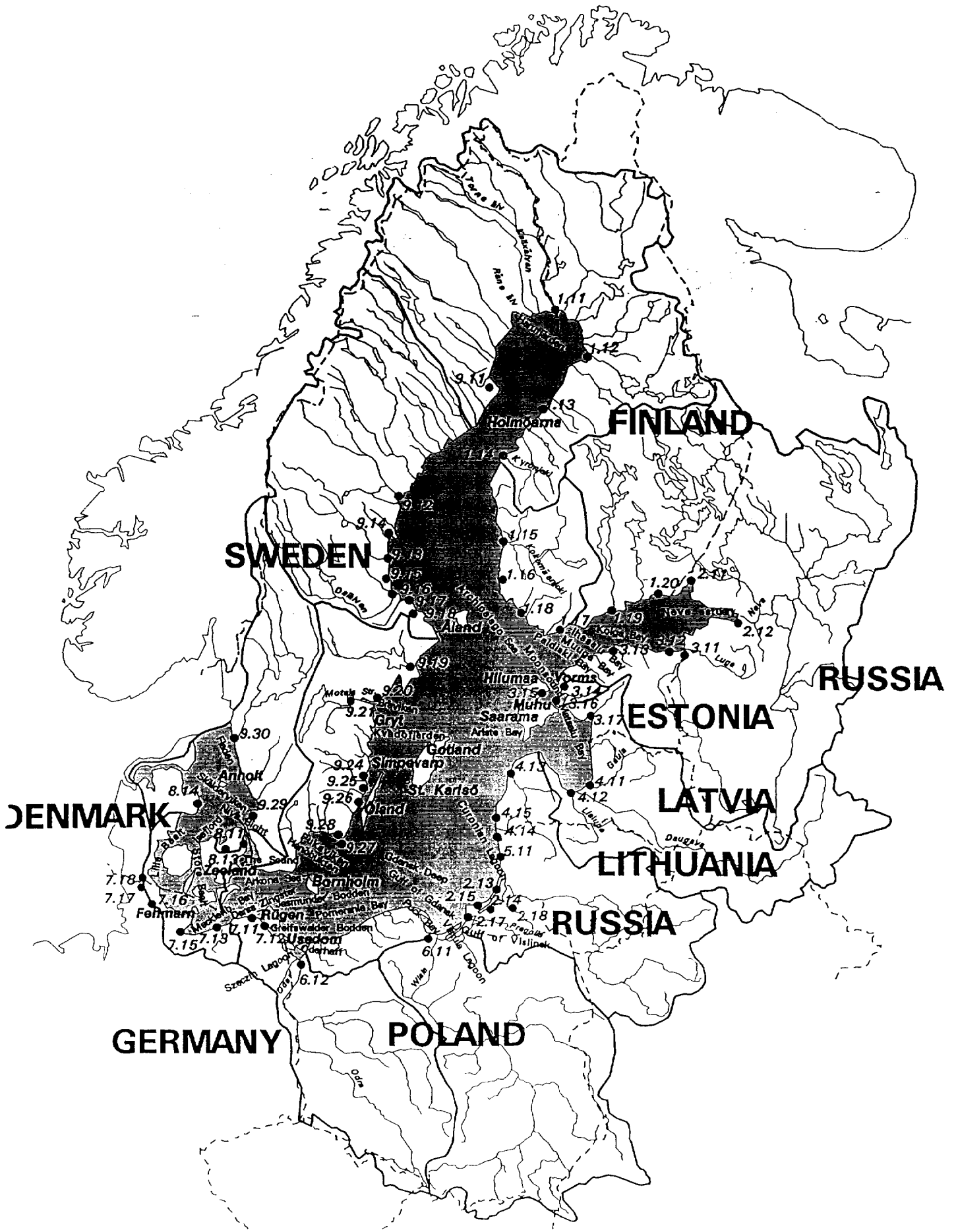

Attachment 1. Places in numerical order according to the countries

- | | | | |
|------|---------------------|------|-------------------|
| 1. | FINLAND | 6. | POLAND |
| 1.11 | Tomio | 6.11 | Gdansk |
| 1.12 | Oulu | 6.12 | Szczecin |
| 1.13 | Kokkola | | |
| 1.14 | Vaasa | 7. | GERMANY |
| 1.15 | Pori | 7.11 | Bodden |
| 1.16 | Pyhämaa | 7.12 | S tralsund |
| 1.17 | Korehar | 7.13 | Wamemiinde |
| 1.18 | Turku | 7.15 | Liibeck |
| 1.19 | Helsinki | 7.16 | Kiel |
| 1.20 | Kotka | 7.17 | Eckenförde |
| | | 7.18 | Flensburg |
| 2. | RUSSIA | | |
| 2.11 | Vyborg | 8. | DENMARK |
| 2.12 | St. Petersburg | 8.11 | Copenhagen |
| 2.13 | Neringa | 8.13 | Roskilde |
| 2.14 | Zelenogradsk | 8.14 | Fomes |
| 2.15 | Pionerskij | | |
| 2.17 | Baltjs | 9. | SWEDEN |
| 2.18 | Kaliningrad | 9.11 | Rönnskär |
| | | 9.12 | Sundsvall |
| 3. | ESTONIA | 9.13 | Söderhamn |
| 3.11 | Narva | 9.14 | Iggesund |
| 3.12 | Toila-Oru | 9.15 | Norrsundet |
| 3.13 | Tallinn | 9.16 | Gävle |
| 3.14 | Haapsalu | 9.17 | Ängsskär |
| 3.15 | Kassaar | 9.18 | Forsmark |
| 3.16 | Nommküla | 9.19 | Stockholm |
| 3.17 | Pärnu | 9.20 | Oxelösund |
| | | 9.21 | Norrköping |
| 4. | LATVIA | 9.24 | Oskarshamn |
| 4.11 | Riga | 9.25 | Mönsterås |
| 4.12 | Jurmala | 9.26 | Kalmar |
| 4.13 | Ventspils | 9.27 | Utklippan |
| 4.14 | Pape | 9.28 | Karlskrona |
| 4.15 | Liepaja | 9.29 | Laholm |
| | | 9.30 | Göteborg |
| 5. | LITHUANIA | | |
| 5.11 | Klaipeda | | |

Attachment 2. Places in alphabetical order

2.17	Baltjs	9.24	Oskarshamn
7.11	Bodden	1.12	Oulu
8.11	Copenhagen	9.20	Oxelösund
7.17	Eckenförde	4.14	Pape
7.18	Flensburg	2.15	Pionerskij
8.14	Fornes	1.15	Pori
9.18	Forsmark	3.17	Pärnu
6.11	Gdansk	1.16	Pyhämaa
9.16	Gävle	4.11	Riga
9.30	Göteborg	9.11	Rönnskär
3.14	Haapsalu	8.13	Roskilde
1.19	Helsinki	9.13	Söderhamn
9.14	Iggesund	2.12	St. Petersburg
4.12	Jurmala	9.19	Stockholm
2.18	Kaliningrad	7.12	Stralsund
9.26	Kalmar	9.12	Sundsvall
9.28	Karlskrona	6.12	Szczecin
3.15	Kassaar	3.13	Tallinn
7.16	Kiel	3.12	Toila-Oru
5.11	Klaipeda	1.11	Tomio
1.13	Kokkola	1.18	Turku
1.17	Korehar	9.27	Utklippan
1.20	Kotka	1.14	Vaasa
9.29	Laholm	4.13	Ventspils
7.15	Liibeck	2.11	Vyborg
4.15	Liepaja	7.13	Warnemünde
9.25	Mönsterås	2.14	Zelenogradsk
3.11	Narva	9.17	Ängsskär
2.13	Neringa		
3.16	Nommküla		
9.21	Norrköping		
9.15	Norrsundet		

BALTIC SEA ENVIRONMENT PROCEEDINGS

- No. 1 JOINT ACTIVITIES OF THE BALTIC SEA STATES WITHIN THE FRAMEWORK OF THE CONVENTION ON THE PROTECTION OF THE MARINE ENVIRONMENT OF THE BALTIC SEA AREA 1974-1978
(1979)*
- No. 2 REPORT OF THE INTERIM COMMISSION (IC) TO THE BALTIC MARINE ENVIRONMENT PROTECTION COMMISSION
(1981)*
- No. 3 ACTIVITIES OF THE COMMISSION 1980
- Report on the activities of the Baltic Marine Environment Protection Commission during 1980
- HELCOM **Recommendations** passed during 1980
(1981)*
- No. 4 BALTIC MARINE ENVIRONMENT BIBLIOGRAPHY 1970-1979
(1981)*
- No. **5A** ASSESSMENT OF THE EFFECTS OF POLLUTION ON THE NATURAL RESOURCES OF THE BALTIC SEA, 1980
PART A-1: OVERALL CONCLUSIONS
(1981)*
- No. **5B** ASSESSMENT OF THE EFFECTS OF POLLUTION ON THE NATURAL RESOURCES OF THE BALTIC SEA, 1980
PART A-1: OVERALL CONCLUSIONS
PART A-2: SUMMARY OF RESULTS
PART B: SCIENTIFIC MATERIAL
(1981)
- No. 6 WORKSHOP ON THE ANALYSIS OF HYDROCARBONS IN SEAWATER
Institut für Meereskunde an der **Universität** Kiel, Department of Marine Chemistry, March 23 - April 3, 1981
(1982)
- No. 7 ACTIVITIES OF THE COMMISSION 1981
- Report of the activities of the Baltic Marine Environment Protection Commission during 1981 including the Third Meeting of the Commission held in Helsinki 16-19 February 1982
- HELCOM Recommendations passed during 1981 and 1982
(1982)
- No. 8 ACTIVITIES OF THE COMMISSION 1982
- Report of the activities of the Baltic Marine Environment Protection Commission during 1982 including the Fourth Meeting of the Commission held in Helsinki 1-3 February 1983
- HELCOM Recommendations passed during 1982 and 1983
(1983)
- No. **9** SECOND BIOLOGICAL INTERCALIBRATION WORKSHOP
Marine Pollution Laboratory and Marine Division of the National Agency of Environmental Protection, Denmark, August 17-20, 1982, **Rønne**, Denmark
(1983)

* out of print

- No. 10 TEN YEARS AFTER THE SIGNING OF THE HELSINKI CONVENTION
National Statements by the Contracting Parties on the Achievements in Implementing the Goals of the Convention on the Protection of the Marine Environment of the Baltic Sea Area
(1984)
- No. 11 STUDIES ON SHIP CASUALTIES IN THE BALTIC SEA 1979-1981
Helsinki University of Technology, Ship Hydrodynamics Laboratory, Otaniemi, Finland
P. Tuovinen, V. Kostilainen and A. Hämäläinen
(1984)
- No. 12 GUIDELINES FOR THE BALTIC MONITORING PROGRAMME FOR THE SECOND STAGE
(1984)*
- No. 13 ACTIVITIES OF THE COMMISSION 1983
- Report of the activities of the Baltic Marine Environment Protection Commission during 1983 including the Fifth Meeting of the Commission held in Helsinki 13-16 March 1984
- HELCOM Recommendations passed during 1983 and 1984
(1984)
- No. 14 SEMINAR ON REVIEW OF PROGRESS MADE IN WATER PROTECTION MEASURES
17-21 October 1983, Espoo, Finland
(1985)
- No. 15 ACTIVITIES OF THE COMMISSION 1984
- Report of the activities of the Baltic Marine Environment Protection Commission during 1984 including the Sixth Meeting of the Commission held in Helsinki 12-15 March 1985
- HELCOM Recommendations passed during 1984 and 1985
(1985)
- No. 16 WATER BALANCE OF THE BALTIC SEA
A Regional Cooperation Project of the Baltic Sea States;
International Summary Report
(1986)
- No. **17A** FIRST PERIODIC ASSESSMENT OF THE STATE OF THE MARINE ENVIRONMENT OF THE BALTIC SEA AREA, 1980-1985; GENERAL CONCLUSIONS
(1986)
- No. 17B FIRST PERIODIC ASSESSMENT OF THE STATE OF THE MARINE ENVIRONMENT OF THE BALTIC SEA AREA, 1980-1985; BACKGROUND DOCUMENT
(1987)
- No. 18 ACTIVITIES OF THE COMMISSION 1985
- Report of the activities of the Baltic Marine Environment Protection Commission during 1985 including the Seventh Meeting of the Commission held in Helsinki 11-14 February 1986
- HELCOM Recommendations passed during 1986
(1986)*
- No. 19 BALTIC SEA MONITORING SYMPOSIUM
Tallinn, USSR, **10-15** March 1986
(1986)
- No. 20 FIRST BALTIC SEA POLLUTION LOAD COMPILATION
(1987)

* out of print

- No. 21 SEMINAR ON REGULATIONS CONTAINED IN ANNEX II OF MARPOL 73/78 AND REGULATION 5 OF ANNEX IV OF THE HELSINKI CONVENTION
National Swedish Administration of Shipping and Navigation;
17-18 November 1986, **Norrköping**, Sweden
(1987)
- No. 22 SEMINAR ON OIL POLLUTION QUESTIONS
19-20 November 1986, **Norrköping**, Sweden
(1987)
- No. 23 ACTIVITIES OF THE COMMISSION 1986
- Report on the activities of the Baltic Marine Environment Protection Commission during 1986 including the Eighth Meeting of the Commission held in Helsinki 24-27 February 1987
- HELCOM Recommendations passed during 1987
(1987)*
- No. 24 PROGRESS REPORTS ON CADMIUM, MERCURY, COPPER AND ZINC
(1987)
- No. 25 SEMINAR ON WASTEWATER TREATMENT IN URBAN AREAS
7-9 September 1986, Visby, Sweden
(1987)
- No. 26 ACTIVITIES OF THE COMMISSION 1987
- Report on the activities of the Baltic Marine Environment Protection Commission during 1987 including the Ninth Meeting of the Commission held in Helsinki 15-19 February 1988
- HELCOM Recommendations passed during 1988
(1988)
- No. 27A GUIDELINES FOR THE BALTIC MONITORING PROGRAMME FOR THE THIRD STAGE;
PART A. INTRODUCTORY CHAPTERS
(1988)
- No. 27B GUIDELINES FOR THE BALTIC MONITORING PROGRAMME FOR THE THIRD STAGE;
PART B. PHYSICAL AND CHEMICAL DETERMINANDS IN SEA WATER
(1988)
- No. 27C GUIDELINES FOR THE BALTIC MONITORING PROGRAMME FOR THE THIRD STAGE;
PART C. HARMFUL SUBSTANCES IN BIOTA AND SEDIMENTS
(1988)
- No. 27D GUIDELINES FOR THE BALTIC MONITORING PROGRAMME FOR THE THIRD STAGE;
PART D. BIOLOGICAL DETERMINANDS
(1988)
- No. 28 RECEPTION OF WASTES FROM SHIPS IN THE BALTIC SEA AREA
- A MARPOL 73/78 SPECIAL AREA
(1989)
- No. 29 ACTIVITIES OF THE COMMISSION 1988
- Report on the activities of the Baltic Marine Environment Protection Commission during 1988 including the Tenth Meeting of the Commission held in Helsinki 14-17 February 1989
- HELCOM Recommendations passed during 1989
(1989)

* out of print

- No. 30 SECOND SEMINAR ON WASTEWATER TREATMENT IN URBAN AREAS
6-8 September 1987, Visby, Sweden
(1989)
- No. 31 THREE YEARS OBSERVATIONS OF THE LEVELS OF SOME RADIONUCLIDES IN THE
BALTIC SEA AFTER THE CHERNOBYL ACCIDENT
Seminar on Radionuclides in the Baltic Sea
29 May 1989, **Rostock-Warnemünde**, German Democratic Republic
(1989)
- No. 32 DEPOSITION OF AIRBORNE POLLUTANTS TO THE BALTIC SEA AREA 1983-1985 AND
1986
(1989)
- No. 33 ACTIVITIES OF THE COMMISSION 1989
- Report on the activities of the Baltic Marine Environment Protection Commission during 1989
including the Eleventh Meeting of the Commission held in Helsinki 13-16 February 1990
- HELCOM Recommendations passed during 1990
(1990)*
- No. 34 STUDY OF THE RISK FOR ACCIDENTS AND THE RELATED ENVIRONMENTAL
HAZARDS FROM THE TRANSPORTATION OF CHEMICALS BY TANKERS IN THE
BALTIC SEA AREA
(1990)
- No. **35A** SECOND PERIODIC ASSESSMENT OF THE STATE OF THE MARINE ENVIRONMENT
OF THE BALTIC SEA, 1984-1988; GENERAL CONCLUSIONS
(1990)
- No. **35B** SECOND PERIODIC ASSESSMENT OF THE STATE OF THE MARINE ENVIRONMENT
OF THE BALTIC SEA, 1984-1988; BACKGROUND DOCUMENT
(1990)
- No. 36 SEMINAR ON NUTRIENTS REMOVAL FROM MUNICIPAL WASTE WATER
4-6 September 1989, Tampere, Finland
(1990)
- No. 37 ACTIVITIES OF THE COMMISSION 1990
- Report on the activities of the Baltic Marine Environment Protection Commission during 1990
including the Twelfth Meeting of the Commission held in Helsinki 19-22 February 1991
- HELCOM Recommendations passed during 1991
(1991)
- No. 38 THIRD BIOLOGICAL INTERCALIBRATION WORKSHOP
27-31 August 1990, Visby, Sweden
(1991)
- No. 39 AIRBORNE POLLUTION LOAD TO THE BALTIC SEA 1986-1990
(1991)
- No. 40 INTERIM REPORT ON THE STATE OF THE COASTAL WATERS OF THE BALTIC SEA
(1991)
- No. 41 INTERCALIBRATIONS AND INTERCOMPARISONS OF MEASUREMENT METHODS FOR
AIRBORNE POLLUTANTS
(1992)

* out of print

- No. 42 ACTIVITIES OF THE COMMISSION 1991
 - Report of the activities of the Baltic Marine Environment Protection Commission during 1991 including the 13th meeting of the Commission held in Helsinki 3-7 February 1992
 - HELCOM Recommendations passed during 1992
 (1992)
- No. 43 BALTIC MARINE ENVIRONMENT BIBLIOGRAPHY 1986-1990
 (1992)
- No. 44 NITROGEN AND AGRICULTURE, INTERNATIONAL WORKSHOP
 9-12 April 1991, Schleswig, Germany
 (1993)
- No. 45 SECOND BALTIC SEA POLLUTION LOAD COMPILATION
 (1993)
- No. 46 SUMMARIES OF THE PRE-FEASIBILITY STUDIES
 Prepared for the Baltic Sea Joint Comprehensive Environmental Action Programme
 (1993)
- No. 47 HIGH LEVEL CONFERENCE ON RESOURCE **MOBILIZATION**
 Gdansk, Poland, 24-25 March 1993
 Compilation of Presentations and Statements
 (1993)
- No. 48 THE BALTIC SEA JOINT COMPREHENSIVE ENVIRONMENTAL ACTION PROGRAMME
 (1993)
- No. 49 THE BALTIC SEA JOINT COMPREHENSIVE ENVIRONMENTAL ACTION PROGRAMME
 Opportunities and Constraints in Programme Implementation
 (1993)
- No. 50** SEMINAR ON RECEPTION FACILITIES IN PORTS
 Turku, Finland, 16-19 November 1992
 (1993)
- No. 51 STUDY OF THE TRANSPORTATION OF PACKAGED DANGEROUS GOODS BY SEA IN
 THE BALTIC SEA AREA AND RELATED ENVIRONMENTAL HAZARDS
 (1993)
- No. 52** ACTIVITIES OF THE COMMISSION 1992
 - Report on the activities of the Baltic Marine Environment Protection Commission during 1992 including the 14th meeting of the Commission held in Helsinki 2-5 February 1993
 - HELCOM Recommendations passed during 1993
 (1993)
- No. 53 BALTIC MARINE ENVIRONMENT BIBLIOGRAPHY 1991-1992
 (1993)

HELSINKI COMMISSION
Baltic Marine Environment Protection Commission

Katajanokanlaituri 6 B
FIN-001 60 Helsinki
Finland

ISSN 0357-2994